



HAVELLS

PROFESSIONAL LUMINAIRES



PRICE LIST
w.e.f. 1st August, 2022



Lighting with Innovation at Havells

At Havells, we believe light is the fourth dimension of architecture. It can guide and direct. It can also enhance and show objects in its dynamic and marvelous self.

We understand every space needs lighting that is tailor-made for it, enhances it and brings everything to life; and it is this property that has been the hallmark in every product that comes out of our factory.

Our luminaires are not merely tools of illumination but the torchbearers of a new era in lighting. They stand testimony to our strength in manufacturing, from OPTO electronics to LED technology and integrating them in our state-of-the-art plants.

Our customers can rely on every aspect of safety, performance and reliability from our products.

And now we present our latest offerings, designed taking into consideration the feedback received from clients, customers and designers alike:

Office Lighting: Paradigms have been redefined with the advent of open plan offices. We are proud to present our range of lighting products for a brighter and more productive office space.

Street Lights: Smart cities evolving in India demand Next-Gen lighting. Havells street lighting range encompasses all the features that are needed for a more efficient lighting system.

Landscape Lighting: The Havells range of landscape lighting products have been revamped and new products introduced, to keep in sync with market dynamics and needs.

Industrial Lighting: The 'Make in India' initiative has given rise to a new set of high-tech industries all over India. The Havells industrial lighting range aims to provide a wide range of lighting solutions to new and existing industries.

Retail Lighting: Retail shopping is all about experience. With Havells retail lighting, deliver new and exciting experiences to customers..

Solar Lighting: Ambitious solar growth in India demands light fittings that are rugged, durable and in tune with latest industry standards. Our range of solar lighting goes a step ahead. People and the environmental footprint are central to our approach and form the basis of our sustainable policy.

Colorscape (Architectural RGB Lighting): Beautiful aesthetics not only make a place beautiful but also helps to lift the mood. Havells Colorscape RGB Lighting solutions lighting up public spaces and structures for improving their visual quality at night & transforming gloomy spots to a cheerful, inviting and secure places.

Impressions (Architectural Indoor Lighting): As workplace design becomes important for employers, Havells Impressions Range opens up fluid possibilities for architects and designers alike. Impressions Architectural Lighting solutions that offer more comfort, low glare, international styling, better aesthetics and best suitable for architectural designs.

Smart Solutions:

- human centric lighting - Work under the shades of nature and watch your efficiency levels rise!
Tailor light to work in harmony with your natural rhythm
- Connected Lighting for Indoor Spaces- A digital ecosystem that connects lighting & IoT technology. Today's workspaces are a maze, navigating technology and efficiency. As offices become more productive, responsive, efficient and human centric, they demand solutions that offer both flexibility and cost-effectiveness. With Havells Connected Lighting for Smart & Intelligent office solutions, that is unmatched.
- Connected Lighting for outdoor Spaces – Havells innovations now enable all outdoor lighting products and luminaires connected with each other. Real time data mapping and controlling as per requirement. A perfect solutions for a smart city
- Automation & sensor enabled solutions - Havells Connected lighting also offers Day light harvesting, occupancy and motion sensing via in-built sensor based designs for making buildings more efficient.

We combine our innovation and extensive experience to create lighting solutions that makes people feel good not only visually but also emotionally.





QRG TOWERS

QRG
EXPERIENCE

HAVELLS

LLOYD

Grabtree

STRONG

QRG Hub/Office

NO ENTRY

Introduction of Plant



CERTIFICATION



Havells lighting plant in Neemrana is spread over 1,21,405.69 m² of land with over 18,580.60 m² of working space under a single roof. The plant has been made keeping in mind the global markets of Europe, US and the Middle East. Setting new benchmarks in the industry, this Havells plant will help bridge the technological divide between Europe and India when it comes to manufacturing high-end lighting luminaries.

Japanese flexible CNC controlled steel fabrication process for the accuracy in sheet punching & bending Italian robotised box bending machines to design complex enclosure shapes without human intervention Automated powder coating paint shop to minimize wastage & fast colour change Eco-friendly zero discharge plant Parabolic rolling machine for replicating complex and accurate forms and shapes Flexible assembly line Modern laboratories.

Building customer confidence by providing a wide range of quality products and service through team work

INDEX

PROFESSIONAL LUMINAIRES (INDUSTRIAL / INSTITUTIONAL)



Indoor Architectural LED Luminaires

Impressions Range

12-18



Indoor Commercial LED Luminaires

Batten

22-24

Retrofit Lamps

25-27

Panel Lighting

28-32

Downlight

33-47



INDEX

PROFESSIONAL LUMINAIRES (INDUSTRIAL / INSTITUTIONAL)



Industrial LED Luminaires

Highbay Lighting / Well Glass / Bulk Head	50-52
Weather Proof / Clean Room Lights	53-54



Outdoor LED Luminaires

Street Lights	56-58
Canopy Fixture	59
Flood Lights	60-62
Landscape Lights	63-72
Colorscape Lights	74-76
Solar Street Lights	78



PRODUCT CODE

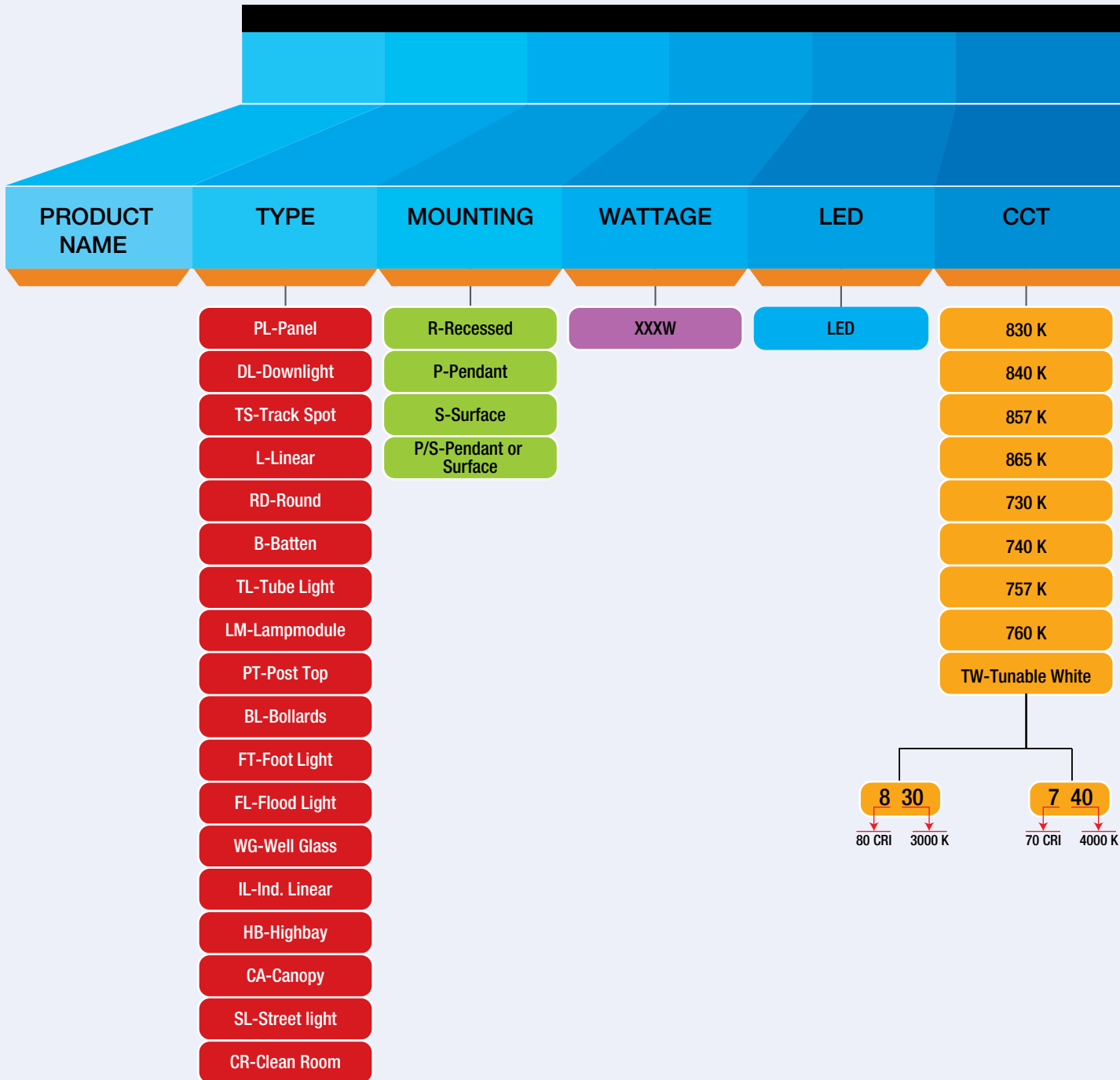

EXAMPLES:

PRODUCT NAME	TYPE	MOUNTING	WATTAGE	LED	CCT
BAYBRITESAUCERHB200WLED757WBTOLTG					
BAYBRITESAUCER	HB	P	200 W	LED	757 K
ENDURPEARLSL15WLED757SASYTOPC					
ENDURPEARL	SL	-	15 W	LED	757 K
VENUSNEOHE2X2PLR18-42WLED857MOD					
VENUSNEOHE2X2	PL	R	34 W	LED	857 K

NOMENCLATURE

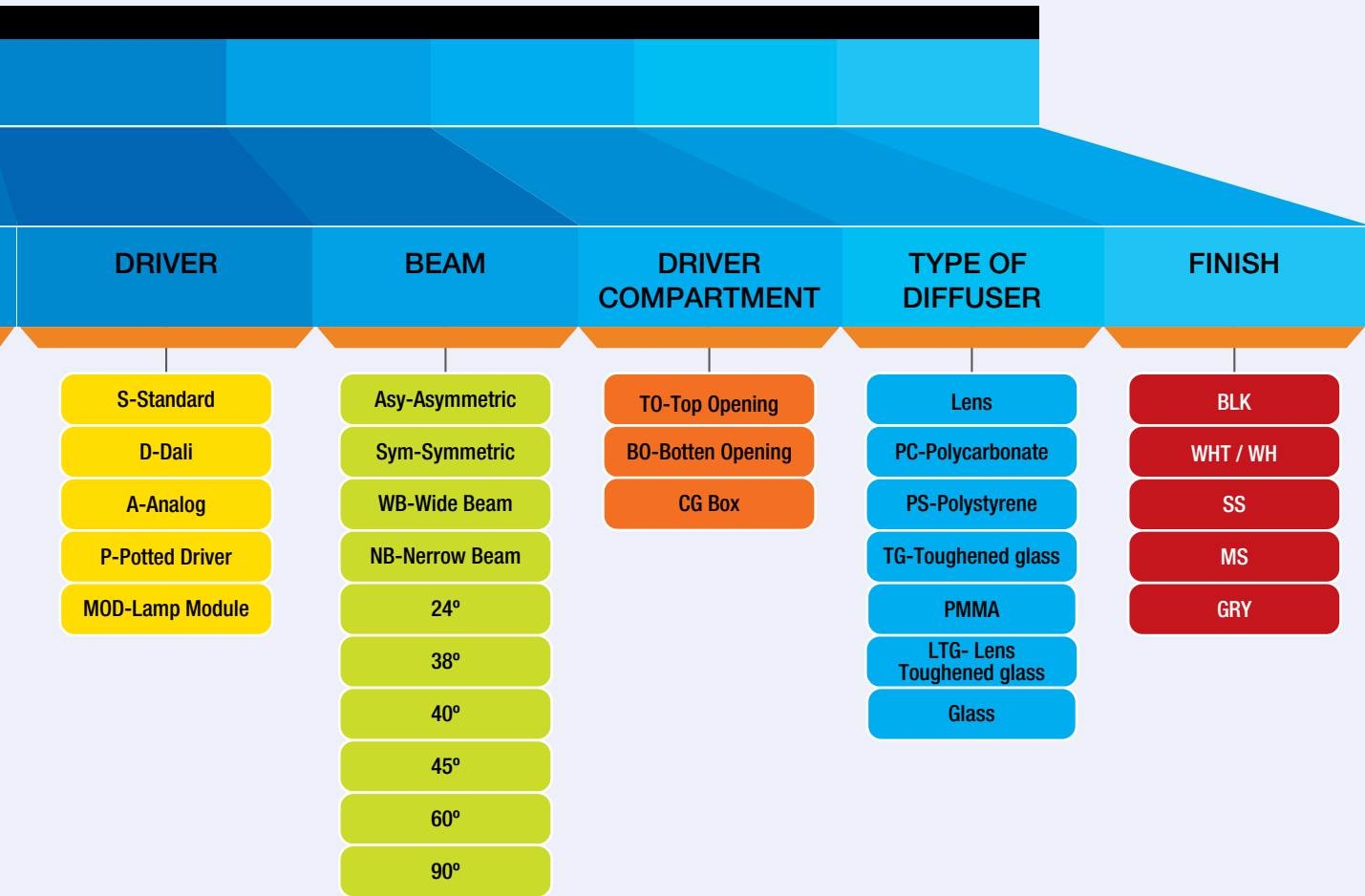

DRIVER	BEAM	DRIVER COMPARTMENT	TYPE OF DIFFUSER	FINISH
-	WB	TO	LTG	-
S	ASY	TO	PC	-
S	-	-	-	-



Indoor Architectural LED Luminaires

Impressions Range by Havells offers an array of ambient and task lighting options that encourage creative freedom and also facilitates a comfortable work environment. Choose from a variety of suspended and floor standing office luminaires offering- ultimate glare comfort measuring UGR as low as 6, special micro reflector optics to meet LEED and WELL building standards, on board occupancy sensor/ photo sensor/ dimming control, separate control of direct and indirect light thus offering a perfect combo of task and ambient lighting, compatibility with DALI/ 0-10V/ POE/ wireless standards, color tunability improving circadian rhythm and breathtaking aesthetics. It's a comprehensive lighting solution with options that complement your office interiors and create an ambience that spells increased productivity and happiness.

MIRAGE PS D LED

A series of slim LED profiles that stand out for their near to invisible light source and neat aesthetics. Designed to create virtually endless uninterrupted lines of light with extremely low UGR levels. The Mirage range features special micro reflector optics comprising minimalistic and highly efficient design with efficacy up to 100 lm/W, Mirage PS D is a great choice for commercial office spaces, schools, libraries and other interior spaces.

Item Description	HSN Code	MRP Rs. Per Unit (incl. of all taxes)	Case Lot No. of unit/s
MIRAGESDLP15WLED840SGRY	9405	23333.00	8 N
MIRAGESDLP15WLED857SGRY	9405	23333.00	8 N
MIRAGESDLP25WLED840SGRY	9405	24167.00	8 N
MIRAGESDLP25WLED857SGRY	9405	24167.00	8 N
MIRAGESDLP30WLED840SGRY	9405	25000.00	8 N
MIRAGESDLP30WLED857SGRY	9405	25000.00	8 N
MIRAGESDLP40WLED840SGRY	9405	25667.00	8 N
MIRAGESDLP40WLED857SGRY	9405	25667.00	8 N

Fixture size: (LxWxH) in (1175x38x66) mm

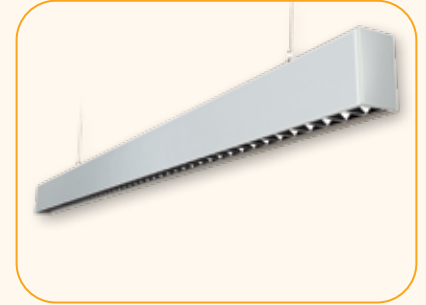

MIRAGE PS DI LED

A series of slim LED profiles that stand out for their near to invisible light source and neat aesthetics. Designed to create virtually endless uninterrupted lines of light with extremely low UGR levels. The Mirage range features special micro reflector optics comprising minimalistic and highly efficient design with efficacy up to 110 lm/W, Mirage PS DI is a great choice for commercial office spaces, schools, libraries and other interior spaces.

Item Description	HSN Code	MRP Rs. Per Unit (incl. of all taxes)	Case Lot No. of unit/s
MIRAGESDILP25WLED840SGRY	9405	26667.00	8 N
MIRAGESDILP25WLED857SGRY	9405	26667.00	8 N
MIRAGESDILP30WLED840SGRY	9405	27667.00	8 N
MIRAGESDILP30WLED857SGRY	9405	27667.00	8 N
MIRAGESDILP40WLED840SGRY	9405	28333.00	8 N
MIRAGESDILP40WLED857SGRY	9405	28333.00	8 N

Fixture size: (LxWxH) in (1175x38x66) mm

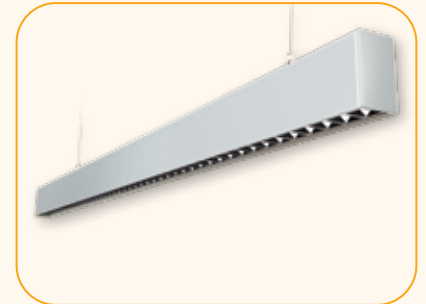

MIRAGE F LED

Mirage F is a freestanding luminaire designed to suit to your individual requirements at the workplace. It features a choice of freestanding or table clamped unit with near to invisible light source and clean-cut aesthetics. This product features special micro reflector optics with minimalistic and highly efficient design meeting the requirements of uniform illumination of individual work planes/ cabins. Mirage F also features specially developed touch control panel for individual on/off, dimming and color tuning thus making 'Human Centric Lighting' accessible to all users with efficacy up to 110 lm/W. Mirage F is a great choice for private offices, high-end cabins and individual workstations.

Item Description	HSN Code	MRP Rs. Per Unit (incl. of all taxes)	Case Lot No. of unit/s
MIRAGEDILFS80WLED80CGRY	9405	150000.00	1 N

Fixture size: (WxH) in (1056x1950) mm



Indoor Architectural LED Luminaires



DESTELLO GENERATION 2 SUSPENDED

Uniquely clean & simple lighting system offering continuous, uniform lines of light across ceilings. The aluminium extruded suspended light gives continuous lines of light distribution with the possibility of various shapes (suspension system included).

Item Description	HSN Code	MRP Rs. Per Unit (incl. of all taxes)	Case Lot No. of unit/s
DESTG250LP/S12WLED840SWH565	9405	6000.00	4 N
DESTG250LP/S12WLED857SWH565	9405	6000.00	4 N
DESTG250LP/S25WLED840SWH1130	9405	8667.00	4 N
DESTG250LP/S25WLED857SWH1130	9405	8667.00	4 N
DESTG250LP/S36WLED840SWH1130	9405	9667.00	4 N
DESTG250LP/S36WLED857SWH1130	9405	9667.00	4 N
DESTG250LP/S50WLED840SWH2260	9405	17333.00	4 N
DESTG250LP/S50WLED857SWH2260	9405	17333.00	4 N
DESTG250LP/SENDCAPBLKX2	9405	300.00	25 N
DESTG250LP/SENDCAPWHX2	9405	300.00	25 N
JKITDESTG250P/S	9405	333.00	25 N
3COREMAINSCABLE1.5MTRWH	9405	333.00	50 N

Fixture size: (LxWxH) in (573x57x85) mm (for 12 W), (1137x57x85) mm (for 25 W, 36 W), (2265x57x85) mm (for 50 W). Joining kit and Mains cable to be ordered separately. End Cap also need to be ordered separately.

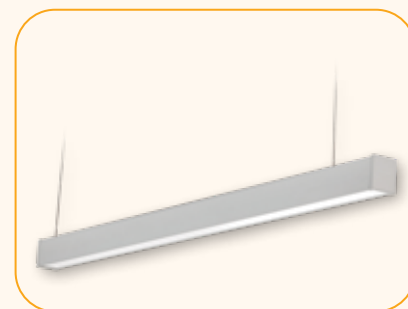

DESTELLO RECESSED

Uniquely clean & simple lighting system offering continuous, uniform lines of light across ceilings. The aluminium extruded recessed light meant for POP/Gypsum ceilings gives continuous lines of light.

Item Description	HSN Code	MRP Rs. Per Unit (incl. of all taxes)	Case Lot No. of unit/s
DESTG250LR12WLED840SWH565	9405	6000.00	4 N
DESTG250LR12WLED857SWH565	9405	6000.00	4 N
DESTG250LR25WLED840SWH1130	9405	8667.00	4 N
DESTG250LR25WLED857SWH1130	9405	8667.00	4 N
DESTG250LR36WLED840SWH1130	9405	9667.00	4 N
DESTG250LR36WLED857SWH1130	9405	9667.00	4 N
DESTG250LR50WLED840SWH2260	9405	17333.00	4 N
DESTG250LR50WLED857SWH2260	9405	17333.00	4 N
DESTG250LP/SENDCAPBLKX2	9405	300.00	25 N
DESTG250LP/SENDCAPWHX2	9405	300.00	25 N
JKITDESTG250REC	9405	333.00	50 N

Fixture size: (LxWxH) in (569x67x40) mm (for 12 W), (1133x67x40) mm (for 25 W, 36 W), (2263x67x40) mm (for 50 W). Joining kit and Mains cable to be ordered separately.

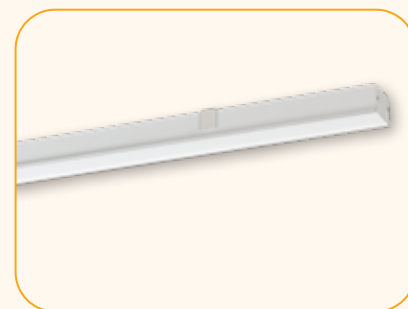

DESTELLO SUSPENDED DIRECT-INDIRECT

Uniquely clean & simple lighting system offering, uniform lines of light across ceilings. The aluminum extruded direct-indirect light effect gives homogenous light distribution effect & enhances the visual comfort (suspension system included).

Item Description	HSN Code	MRP Rs. Per Unit (incl. of all taxes)	Case Lot No. of unit/s
DESTELLODILP36WLED840SPMMAWH	9405	16333.00	4 N
DESTELLODILP36WLED857SPMMAWH	9405	16333.00	4 N
3COREMAINSCABLE1.5MTRWH	9405	333.00	50 N
JOININGKITFORDESTELLO50P/S/DI	9405	333.00	25 N

Fixture size: (LxWxH) in (1136x54x74) mm
Joining kit and Mains cable to be ordered separately

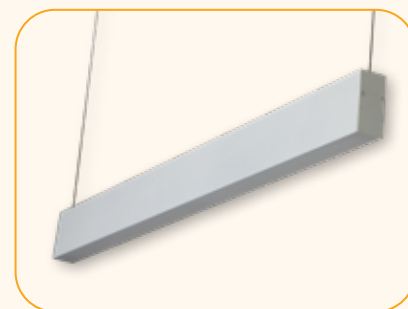

DESTELLO RECESSED Y SHAPE

Destello connectors to create, Y shape pattern with seamless connectivity in recessed as well as suspended mounting arrangements.

Item Description	HSN Code	MRP Rs. Per Unit (incl. of all taxes)	Case Lot No. of unit/s
DESTG250YR36WLED840SWH577	9405	On Request	2 N
DESTG250YR36WLED857SWH577	9405	On Request	2 N

Fixture size: (LxWxH) in (1033x580x40) mm

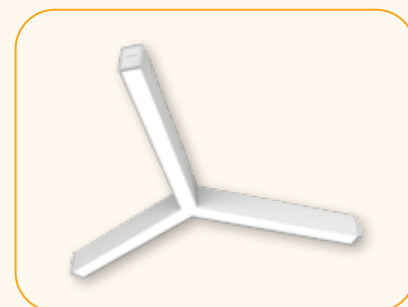

DESTELLO SUSPENDED Y SHAPE

Destello connectors to create, Y shape pattern with seamless connectivity in recessed as well as suspended mounting arrangements.

Item Description	HSN Code	MRP Rs. Per Unit (incl. of all taxes)	Case Lot No. of unit/s
DESTG250YP/S36WLED840SWH577	9405	On Request	2 N
DESTG250YP/S36WLED857SWH577	9405	On Request	2 N

Fixture size: (LxWxH) in (1033x580x85) mm

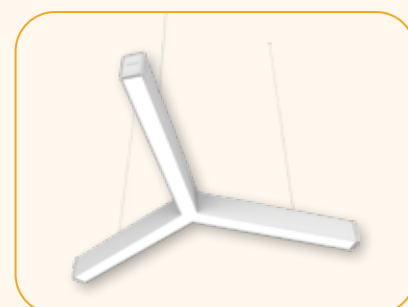

DESTELLO RECESSED L SHAPE

Destello connectors to create, L shape pattern with seamless connectivity in recessed as well as suspended mounting arrangements.

Item Description	HSN Code	MRP Rs. Per Unit (incl. of all taxes)	Case Lot No. of unit/s
DESTG25090DR25WLED840SWH577	9405	On Request	4 N
DESTG25090DR25WLED857SWH577	9405	On Request	4 N

Fixture size: (LxWxH) in (588x586x40) mm



DESTELLO SUSPENDED L SHAPE

Destello connectors to create, L shape pattern with seamless connectivity in recessed as well as suspended mounting arrangements.

Item Description	HSN Code	MRP Rs. Per Unit (incl. of all taxes)	Case Lot No. of unit/s
DESTG25090DP/S25WLED840SWH577	9405	On Request	4 N
DESTG25090DP/S25WLED857SWH577	9405	On Request	4 N

Fixture size: (LxWxH) in (586x586x85) mm



DESTELLO RECESSED X SHAPE

Destello connectors to create, X shape pattern with seamless connectivity in recessed as well as suspended mounting arrangements.

Item Description	HSN Code	MRP Rs. Per Unit (incl. of all taxes)	Case Lot No. of unit/s
DESTG250XR48WLED840SWH577	9405	On Request	2 N
DESTG250XR48WLED857SWH577	9405	On Request	2 N

Fixture size: (LxWxH) in (1040x625x40) mm



Indoor Architectural LED Luminaires

IMPRESSIONS

DESTELLO SUSPENDED X SHAPE

Destello connectors to create, X shape pattern with seamless connectivity in recessed as well as suspended mounting arrangements.

Item Description	HSN Code	MRP Rs. Per Unit (incl. of all taxes)	Case Lot No. of unit/s
DESTG250XP/S48WLED840SWH577	9405	On Request	2 N
DESTG250XP/S48 WLED857SWH577	9405	On Request	2 N

Fixture size: (LxWxH) in (1040x625x85) mm

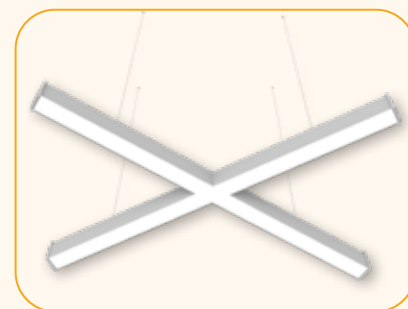

DESTELLO RECESSED + SHAPE

Destello connectors to create, + shape pattern with seamless connectivity in recessed as well as suspended mounting arrangements.

Item Description	HSN Code	MRP Rs. Per Unit (incl. of all taxes)	Case Lot No. of unit/s
DESTG250+R48WLED840SWH577	9405	On Request	2 N
DESTG250+R48WLED857SWH577	9405	On Request	2 N

Fixture size: (LxWxH) in (1040x1040x40) mm

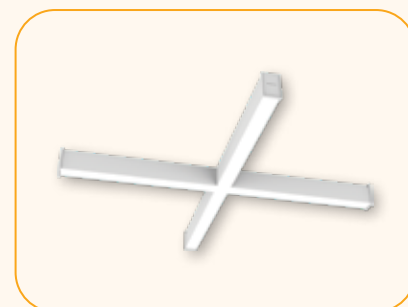

DESTELLO SUSPENDED + SHAPE

Destello connectors to create, + shape pattern with seamless connectivity in recessed as well as suspended mounting arrangements.

Item Description	HSN Code	MRP Rs. Per Unit (incl. of all taxes)	Case Lot No. of unit/s
DESTG250+P/S48WLED840SWH577	9405	On Request	2 N
DESTG250+P/S48WLED857SWH577	9405	On Request	2 N

Fixture size: (LxWxH) in (1040x1040x85) mm

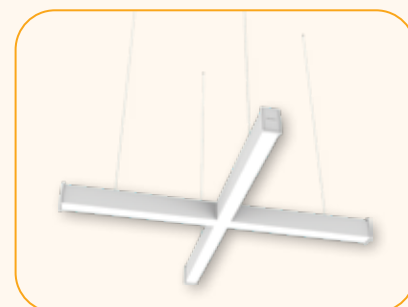

ILLUMINO

Uniquely clean & simple lighting system offering continuous, uniform lines of light across ceilings. The aluminium extruded suspended light gives continuous lines of light distribution.

Item Description	HSN Code	MRP Rs. Per Unit (incl. of all taxes)	Case Lot No. of unit/s
ILLUMINO50LP/S12WLED830SWH566	9405	5998.00	8 N
ILLUMINO50LP/S12WLED840SWH566	9405	5998.00	8 N
ILLUMINO50LP/S12WLED857SWH566	9405	5998.00	8 N
ILLUMINO50LP/S22WLED830SWH1130	9405	8667.00	8 N
ILLUMINO50LP/S22WLED840SWH1130	9405	8667.00	8 N
ILLUMINO50LP/S22WLED857SWH1130	9405	8667.00	8 N
ILLUMINO50LP/S34WLED830SWH1694	9405	14000.00	8 N
ILLUMINO50LP/S34WLED840SWH1694	9405	14000.00	8 N
ILLUMINO50LP/S34WLED857SWH1694	9405	14000.00	8 N
ILLUMINO50LP/S45WLED830SWH2258	9405	16667.00	8 N
ILLUMINO50LP/S45WLED840SWH2258	9405	16667.00	8 N
ILLUMINO50LP/S45WLED857SWH2258	9405	16667.00	8 N

Fixture size: (LxWxH) in (1175x38x66) mm

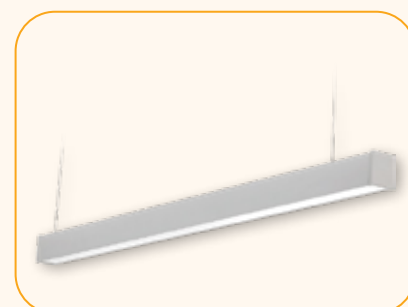

LUMENTO

Uniquely clean & simple lighting system offering continuous, uniform lines of light across ceilings. The aluminium extruded suspended light are installed in a standalone manner and there is no provision for continuous mounting arrangement.

Item Description	HSN Code	MRP Rs. Per Unit (incl. of all taxes)	Case Lot No. of unit/s
LUMENTO50LP/S25WLED830SWH1137	9405	7167.00	2 N
LUMENTO50LP/S25WLED840SWH1137	9405	7167.00	2 N
LUMENTO50LP/S25WLED857SWH1137	9405	7167.00	2 N
LUMENTO50LP/S50WLED830SWH2265	9405	14167.00	2 N
LUMENTO50LP/S50WLED840SWH2265	9405	14167.00	2 N
LUMENTO50LP/S50WLED857SWH2265	9405	14167.00	2 N

Fixture size: (LxWxH) in (1195x146x50) mm

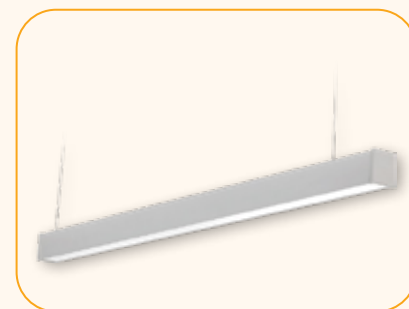

SABER

SABER LED merges classic styling with cutting edge technology to provide quality illumination and superior optical control. Use of direct/ indirect LED light engines makes it excellent choice for low height ceiling applications and areas where ceiling uniformity and indirect lighting is important (suspension system included).

Item Description	HSN Code	MRP Rs. Per Unit (incl. of all taxes)	Case Lot No. of unit/s
SABERLP36WLED840SPMMAWH	9405	16333.00	2 N
SABERLP36WLED857SPMMAWH	9405	16333.00	2 N
JOININGKITFORSABER	9405	400.00	25 N
3COREMAINSCABLE1.5MTRWH	9405	333.00	50 N

Fixture size: (LxWxH) in (1271x163x46) mm. Joining kit and Mains cable to be ordered separately.

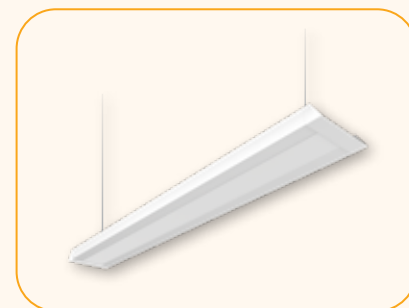

LICON

LICON LED merges classic styling with cutting edge technology to provide quality illumination and superior optical control. Use of direct/ indirect LED light engines makes it excellent choice for low height ceiling applications and areas where ceiling uniformity and indirect lighting is important (secondary suspension kit included).

Item Description	HSN Code	MRP Rs. Per Unit (incl. of all taxes)	Case Lot No. of unit/s
LICONLP36WLED840SPCGRY	9405	12667.00	1 N
LICONLP36WLED857SPCGRY	9405	12667.00	1 N
LICONSUSKITWITHMAINSCABLE	9405	567.00	

Fixture size: (LxWxH) in (1206x170x40) mm
Primary suspension kit with mains cable to be ordered separately



TECHZONE

Uniquely clean & simple lighting system offering continuous light for Armstrong Techzone ceiling system. The minimal design offers outstanding visual comfort with end to end seamless integration.

Item Description	HSN Code	MRP Rs. Per Unit (incl. of all taxes)	Case Lot No. of unit/s
TZLR25WLED840SPSWH1195	9405	9333.00	2 N
TZLR25WLED857SPSWH1195	9405	9333.00	2 N
TZLR36WLED840SPSWH1195	9405	9500.00	2 N
TZLR36WLED857SPSWH1195	9405	9500.00	2 N
TZLR48WLED840SPSWH1195	9405	10000.00	2 N
TZLR48WLED857SPSWH1195	9405	10000.00	2 N

Fixture size: (LxWxH) in (1195x146x50) mm

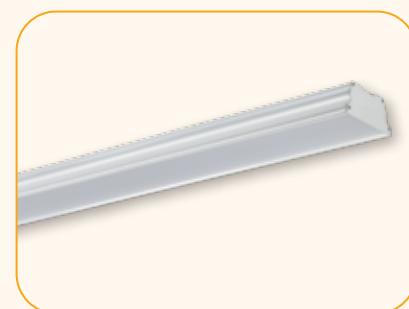

Indoor Architectural LED Luminaires

IMPRESSIONS

WINGO

Specially designed direct-indirect transparent optical system which provides sufficient light levels on work plane and at the same time illuminating the ceiling with a harmonious and pleasant appearance.

Item Description	HSN Code	MRP Rs. Per Unit (incl. of all taxes)	Case Lot No. of unit/s
WINGOLP40WLED830SPMMABLK	9405	21667.00	1 N
WINGOLP40WLED840SPMMABLK	9405	21667.00	1 N
WINGOLP40WLED857SPMMABLK	9405	21667.00	1 N

Fixture size: (LxWxH) in (1112x280x48) mm



CONSTA LED

Suspended architectural LED luminaire provides soft-light and glare free symmetrical illumination (with continuous mounting end cap).

Item Description	HSN Code	MRP Rs. Per Unit (incl. of all taxes)	Case Lot No. of unit/s
CONSTA1144LP20WLED830SPCWH	9405	5833.00	4 N
CONSTA1144LP20WLED840SPCWH	9405	5833.00	4 N
CONSTA1144LP20WLED857SPCWH	9405	5833.00	4 N
CONSTA1144LP40WLED830SPCWH	9405	6333.00	4 N
CONSTA1144LP40WLED840SPCWH	9405	6333.00	4 N
CONSTA1144LP40WLED857SPCWH	9405	6333.00	4 N
CONSTA544LP20WLED830SPCWH	9405	4333.00	4 N
CONSTA544LP20WLED840SPCWH	9405	4333.00	4 N
CONSTA544LP20WLED857SPCWH	9405	4333.00	4 N

Fixture size: (LxWxH) in (1200x106x61) mm (for 20 W, 40 W), (602x106x61) mm (for 20 W)

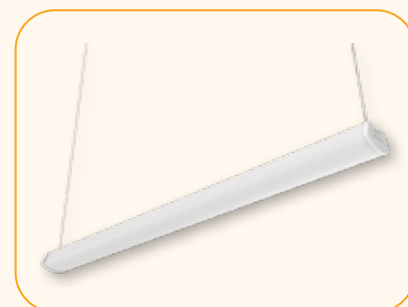

TORUS

In a sector commanded by rectangular luminaires, this circular luminaire impresses with an effective height of 70 mm and produces diffused planar and low-glare light. The annular shape further gives the luminaire a sturdy appearance marking entreating attraction.

Item Description	HSN Code	MRP Rs. Per Unit (incl. of all taxes)	Case Lot No. of unit/s
TORUS600RDP/S25WLED830SPMMAWH	9405	21667.00	2 N
TORUS600RDP/S25WLED840SPMMAWH	9405	21667.00	2 N
TORUS600RDP/S25WLED857SPMMAWH	9405	21667.00	2 N
MONDOMOUNTINGKITP	9405	833.00	25 N
MONDOMOUNTINGKITS	9405	833.00	25 N

Fixture size: Dia 600 mm, Height 78 mm. Mounting Kits to be ordered separately



MONDO RECESSED

Energy saving, environmental friendly, long life, corrosion resistant, decorative recessed luminaires with PMMA diffuser and extruded aluminium housing with LEDs as light source.

Item Description	HSN Code	MRP Rs. Per Unit (incl. of all taxes)	Case Lot No. of unit/s
MONDO 400 REC 25W LED 830 WHT	9405	11667.00	4 N
MONDO 400 REC 25W LED 840 WHT	9405	11667.00	4 N
MONDO 400 REC 25W LED 857 WHT	9405	11667.00	4 N
MONDO 600 REC 36W LED 830 WHT	9405	16667.00	6 N
MONDO 600 REC 36W LED 840 WHT	9405	16667.00	6 N
MONDO 600 REC 36W LED 857 WHT	9405	16667.00	6 N

Fixture size: Dia 416 mm, Height 78 mm for 25 W, Dia 616 mm, Height 78 mm for 36 W



MONDO

Energy saving, environmental friendly, long life, decorative, corrosion resistant, surface-suspended luminaires with annular shape and opal diffuser contributing towards impudent identity and delivers an aesthetically appealing.

Item Description	HSN Code	MRP Rs. Per Unit (incl. of all taxes)	Case Lot No. of unit/s
MONDO400RDP/S25WLED830SPSWH	9405	11667.00	4 N
MONDO400RDP/S25WLED840SPSWH	9405	11667.00	4 N
MONDO400RDP/S25WLED857SPSWH	9405	11667.00	4 N
MONDO600RDP/S36WLED830SPSWH	9405	16667.00	6 N
MONDO600RDP/S36WLED840SPSWH	9405	16667.00	6 N
MONDO600RDP/S36WLED857SPSWH	9405	16667.00	6 N
MONDOMOUNTINGKITP	9405	833.00	25 N
MONDOMOUNTINGKITS	9405	833.00	25 N
MONDO SUSPENSION KIT	9405	000.00	25 N

Fixture size: Dia 400 mm, Height 70 mm for 25 W, Dia 600 mm, Height 70 mm for 36 W
Mounting Kits to be ordered separately



MONDO HEXA

Energy saving, environmental friendly, long life, corrosion resistant, decorative hexagon shaped, surface/suspended luminaires with PMMA diffuser and extruded aluminium housing with LEDs as light source.

Item Description	HSN Code	MRP Rs. Per Unit (incl. of all taxes)	Case Lot No. of unit/s
MONDO600HEXP/S36WLED830SPSWH	9405	21667.00	2 N
MONDO600HEXP/S36WLED840SPSWH	9405	21667.00	2 N
MONDO600HEXP/S36WLED857SPSWH	9405	21667.00	2 N

Fixture size: (LxWxH) in (600x520x81) mm







Indoor Commercial LED Luminaires

Indoor lighting is an art. Havells understands human centric lighting which improves well-being and increases productivity. Hallmark of every luminaires shipped from Havells factory is a silent whisper of creativity and technology at its best.

LUMILINE

Basic all purpose surface and wall mounted LED batten with polycarbonate housing & integrated electronic driver.

Item Description	HSN Code	MRP Rs. Per Unit (incl. of all taxes)	Case Lot No. of unit/s
LUMILINEBS9WLED830SPCWH	9405	540.00	20 N
LUMILINEBS9WLED840SPCWH	9405	540.00	20 N
LUMILINEBS9WLED865SPCWH	9405	540.00	20 N
LUMILINEBS10WLED865SPCWH	9405	540.00	20 N
LUMILINEBS18WLED830SPCWH	9405	590.00	30 N
LUMILINEBS18WLED840SPCWH	9405	590.00	30 N
LUMILINEBS18WLED865SPCWH	9405	590.00	30 N
LUMILINEBS20WLED830SPCWH	9405	650.00	30 N
LUMILINEBS20WLED840SPCWH	9405	650.00	30 N
LUMILINEBS20WLED865SPCWH	9405	650.00	30 N
LUMILINEBS22WLED865SPCWH	9405	670.00	20 N

Fixture size: (LxWxH) in (600x24x35) mm (for 9 W / 10 W), (1150x24x35) mm (for 18 W / 20 W / 22 W)
NOTE: SUITABLE FOR DOMESTIC APPLICATION ONLY



LUMILINE NEO

Basic all purpose surface and wall mounted LED batten with polycarbonate housing & integrated electronic driver.

Item Description	HSN Code	MRP Rs. Per Unit (incl. of all taxes)	Case Lot No. of unit/s
LUMILINENEBS18WLED830SPCWH	9405	590.00	40 N
LUMILINENEBS18WLED840SPCWH	9405	590.00	40 N
LUMILINENEBS18WLED865SPCWH	9405	590.00	40 N
LUMILINENEBS20WLED830SPCWH	9405	650.00	40 N
LUMILINENEBS20WLED840SPCWH	9405	650.00	40 N
LUMILINENEBS20WLED865SPCWH	9405	650.00	40 N
LUMILINENEBS22WLED830SPCWH	9405	670.00	40 N
LUMILINENEBS22WLED840SPCWH	9405	670.00	40 N
LUMILINENEBS22WLED865SPCWH	9405	670.00	40 N

Fixture size: (LxWxH) in (1100x24x35) mm
NOTE: SUITABLE FOR DOMESTIC APPLICATION ONLY



LUMILINE PLUS

Basic all purpose surface and wall mounted LED batten with aluminum housing & integrated electronic driver.

Item Description	HSN Code	MRP Rs. Per Unit (incl. of all taxes)	Case Lot No. of unit/s
LUMILINE+BS10WLED865SPCSS	9405	625.00	20 N
LUMILINE+BS18WLED830SPCSS	9405	900.00	30 N
LUMILINE+BS18WLED840SPCSS	9405	900.00	30 N
LUMILINE+BS18WLED865SPCSS	9405	900.00	30 N
LUMILINE+BS20WLED830SPCSS	9405	935.00	30 N
LUMILINE+BS20WLED840SPCSS	9405	935.00	30 N
LUMILINE+BS20WLED865SPCSS	9405	935.00	30 N
LUMILINE+BS22WLED865SPCSS	9405	965.00	20 N
LUMILINE+BS24WLED865SPCSS	9405	990.00	20 N

Fixture size: (LxWxH) in (592x23x37) mm (for 10 W), (1182x23x37) mm (for 18 W / 20 W / 22 W / 24 W)
NOTE: SUITABLE FOR DOMESTIC APPLICATION ONLY



Indoor Commercial LED Luminaires

BATTEN

LUMILINE PLUS NEO

Basic all purpose surface and wall mounted LED batten with aluminum housing & integrated electronic driver.

Item Description	HSN Code	MRP Rs. Per Unit (incl. of all taxes)	Case Lot No. of unit/s
LUMILINEPLUSNEOBS18WLED830SPCSSIND	9405	900.00	30 N
LUMILINEPLUSNEOBS18WLED840SPCSSIND	9405	900.00	30 N
LUMILINEPLUSNEOBS18WLED865SPCSSIND	9405	900.00	30 N
LUMILINEPLUSNEOBS20WLED830SPCSSIND	9405	935.00	30 N
LUMILINEPLUSNEOBS20WLED840SPCSSIND	9405	935.00	30 N
LUMILINEPLUSNEOBS20WLED865SPCSSIND	9405	935.00	30 N
LUMILINEPLUSNEOBS22WLED830SPCSSIND	9405	965.00	30 N
LUMILINEPLUSNEOBS22WLED865SPCSSIND	9405	965.00	30 N
LUMILINEPLUSNEOBS24WLED830SPCSSIND	9405	990.00	30 N
LUMILINEPLUSNEOBS24WLED865SPCSSIND	9405	990.00	30 N

Fixture size: (LxWxH) in (1100x23x37) mm

NOTE: SUITABLE FOR DOMESTIC APPLICATION ONLY



ENDURA LINEAR NEO

Basic all purpose surface and wall mounted LED batten with powdered coated aluminum housing & integrated electronic driver with THD<10%.

Item Description	HSN Code	MRP Rs. Per Unit (incl. of all taxes)	Case Lot No. of unit/s
ENDURALINEARNEOBS10WLED865SPCWH	9405	1345.00	20 N
ENDURALINEARNEOBS20WLED865SPCWH	9405	1900.00	20 N
ENDURALINEARNEOBS22WLED865SPCWH	9405	2000.00	20 N

Fixture size: (LxWxH) in (581x25x35) mm (for 10 W), (1144x25x35) mm (for 22 W / 24 W)

NOTE: SUITABLE FOR DOMESTIC APPLICATION ONLY



ENDURA LINEAR NEO

Basic all purpose surface and wall mounted LED batten with anodized aluminum housing & integrated electronic driver with THD<10%.

Item Description	HSN Code	MRP Rs. Per Unit (incl. of all taxes)	Case Lot No. of unit/s
ENDURALINEARNEOBS10WLED865SPCSS	9405	950.00	30 N
ENDURALINEARNEOBS20WLED865SPCSS	9405	1000.00	30 N
ENDURALINEARNEOBS22WLED865SPCSS	9405	1100.00	30 N

Fixture size: (LxWxH) in (581x25x35) mm (for 10 W), (1144x25x35) mm (for 22 W / 24 W)

NOTE: SUITABLE FOR DOMESTIC APPLICATION ONLY



LUMILINE X

Basic all purpose surface and wall mounted LED batten integrated electronic driver with lumen efficacy >=120.

Item Description	HSN Code	MRP Rs. Per Unit (incl. of all taxes)	Case Lot No. of unit/s
LUMILINEXS17WLED865SPCWH	9405	950.00	20 N
LUMILINE+XS36WLED865SPCWH	9405	1675.00	20 N

Fixture size: (LxWxH) in (1100x23x37) mm (for 17 W), (1185x35x40) mm (for 36 W)



LUMILINE SMART

LED batten with Microwave motion technology for providing an energy-efficient solution and with aluminum housing & integrated electronic driver.

Item Description	HSN Code	MRP Rs. Per Unit (incl. of all taxes)	Case Lot No. of unit/s
LUMILINESMART20WLED865PCWH	9405	2000.00	20 N
LUMILINESMART36WLED865PCWH	9405	2800.00	20 N

Fixture size: (LxWxH) in (1185x23x37) mm (for 20 W), (1185x35x40) mm (for 36 W)



DURA BATTEN

Surface /Suspended and wall mounted LED batten, CRCA housing provided for efficient heat dissipation with polycarbonate diffuser & built-in electronic driver with THD<10% & Lumen efficacy >=115 lm/W.

Item Description	HSN Code	MRP Rs. Per Unit (incl. of all taxes)	Case Lot No. of unit/s
DURABS40WLED840SPCSS	9405	2100.00	20 N
DURABS40WLED865SPCSS	9405	2100.00	20 N

Fixture size: (LxWxH) in (1213x30x36) mm



REGAL BATTEN

General purpose industrial compact batten suitable for single or twin LED Tubelight with integral LED driver, available in single / double side connection options.

Item Description	HSN Code	MRP Rs. Per Unit (incl. of all taxes)	Case Lot No. of unit/s
REGALBATTENT8UPTO1X22WDSBSWH	9405	650.00	15 N
REGALBATTENT8UPTO1X22WSSBSWH	9405	450.00	15 N
REGALBATTENT8UPTO2X22WDSBSWH	9405	650.00	15 N
REGALBATTENT8UPTO2X22WSSBSWH	9405	450.00	15 N

Fixture size: (LxWxH) in (1224x38x68) mm (for 1x22 W), (1224x38x71) mm (for 2x22 W)



STREAK BATTEN

General purpose industrial compact batten suitable for single or twin LED Tube light with integral LED driver, available in single / double side connection options.

Item Description	HSN Code	MRP Rs. Per Unit (incl. of all taxes)	Case Lot No. of unit/s
STREAKT8UPTO1X22WSSBSWH	9405	300.00	20 N
STREAKT8UPTO1X22WDSBSWH	9405	300.00	20 N
STREAKT8UPTO2X22WSSBSWH	9405	350.00	20 N
STREAKT8UPTO2X22WDSBSWH	9405	350.00	20 N

Fixture size: (LxWxH) in (1233x36x46) mm (for 1x22 W), (1233x71x46) mm (for 2x22 W)



STREAK NEO BATTEN

General purpose industrial compact batten suitable for single or twin LED Tube light with integral LED driver, available in single / double side connection options.

Item Description	HSN Code	MRP Rs. Per Unit (incl. of all taxes)	Case Lot No. of unit/s
STREAKNEOT8UPTO1X22WSSBSWH	9405	300.00	20 N
STREAKNEOT8UPTO1X22WDSBSWH	9405	300.00	20 N
STREAKNEOT8UPTO2X22WSSBSWH	9405	350.00	20 N
STREAKNEOT8UPTO2X22WDSBSWH	9405	350.00	20 N

Fixture size: (LxWxH) in (1233x36x46) mm (for 1x22 W), (1233x71x46) mm (for 2x22 W)



Indoor Commercial LED Luminaires

LAMPS

PHOTON ULTRA 2.0 TUBELIGHT <15%

Ultra bright LED Tubelight (single side connection) with very high efficacy & THD <15% best suited for installation in existing tubelight luminaire with G13 lamp holders to give glare free light.

Item Description	HSN Code	MRP Rs. Per Unit (incl. of all taxes)	Case Lot No. of unit/s
PHOTONULTRAE2.0603T8SSTL10WLED865SPC	9405	540.00	30 N
PHOTONULTRAE2.01213T8SSTL18WLED865SPC	9405	725.00	30 N
PHOTONULTRAE2.01213T8SSTL20WLED865SPC	9405	725.00	30 N

Fixture size: (ØxL) in (28x603) mm (for 10 W), (28x1213) mm (for 18 W / 20 W)



PHOTON ULTRA PLUS 2.0 TUBELIGHT <10%

Ultra bright LED Tubelight (single side connection) with very high efficacy ≥ 115 lm/W & THD<10% suited for installation in existing tubelight luminaire with G13 lamp holders to give glare free light.

Item Description	HSN Code	MRP Rs. Per Unit (incl. of all taxes)	Case Lot No. of unit/s
PHOTONULTRA2.01213T8SSTL18WLED865SPC	9405	1325.00	30 N
PHOTONULTRA2.01213T8SSTL20WLED865SPC	9405	1325.00	30 N

Fixture size: (ØxL) in (28x1213) mm (for 18 W / 20 W)



CRYSTAL GLASS LED TUBELIGHT

Ultra bright LED Tubelight with very high efficacy suited for installation in existing tubelight G13 lamp holders to give glare free light.

Item Description	HSN Code	MRP Rs. Per Unit (incl. of all taxes)	Case Lot No. of unit/s
CRYSTALT81213SSTL18WLED865SGLASS	9405	600.00	20 N
CRYSTALT81213SSTL20WLED865SGLASS	9405	600.00	20 N

Fixture size: (ØxL) in (28x1213) mm



TITANIA NEO LED TUBELIGHT

Ultra bright LED Tubelight (single side connection) with very high efficacy ≥ 105 lm/W best suited for installation in existing tubelight luminaire with G13 lamp holders to give glare free light.

Item Description	HSN Code	MRP Rs. Per Unit (incl. of all taxes)	Case Lot No. of unit/s
TITANIANEO1213T8SSTL18WLED865SPC	9405	1100.00	20 N
TITANIANEO1213T8SSTL20WLED865SPC	9405	1100.00	20 N

Fixture size: (ØxL) in (28x1213) mm



TITANIA PLUS 2.0 LED TUBELIGHT

Ultra bright LED Tubelight (single side connection) with Aluminium insert/housing & very high efficacy ≥ 120 lm/W best suited for installation in existing tubelight luminaire with G13 lamp holders to give glare free light.

Item Description	HSN Code	MRP Rs. Per Unit (incl. of all taxes)	Case Lot No. of unit/s
TITANIAPLUS2.01213T8SSTL18WLED865SPC	9405	1250.00	20 N
TITANIAPLUS1213T8SSTL30WLED865SPC	9405	1750.00	20 N

Fixture size: (ØxL) in (28x1213) mm



Indoor Commercial LED Luminaires

BATTEN / LAMPS

PHOTON ULTRA PL-L

Ultra bright LED PLL with very high efficacy suited for installation in existing 2G11 lamp holders to give glare free light.

Item Description	HSN Code	MRP Rs. Per Unit (incl. of all taxes)	Case Lot No. of unit/s
PHOTONULTRAPLL419TL18WLED865SPC	9405	1135.00	20 N
Fixture size: (LxWxH) in (410x24x44) mm			



HERCULES PL-L

Ultra bright LED PLL with very high efficacy suited for installation in existing 2G11 lamp holders to give glare free light.

Item Description	HSN Code	MRP Rs. Per Unit (incl. of all taxes)	Case Lot No. of unit/s
HERCULESPLL419TL18WLED865SPC	9405	900.00	20 N
Fixture size: (LxWxH) in (410x24x44) mm			



STOUT PLUS

Industrial LED batten with THD <10%. Perfect for lighting large areas like corridors, warehouses & general purpose spaces.

Item Description	HSN Code	MRP Rs. Per Unit (incl. of all taxes)	Case Lot No. of unit/s
STOUTPLUS600BS20WLED840SPCWH	9405	3300.00	4 N
STOUTPLUS600BS20WLED857SPCWH	9405	3300.00	4 N
STOUTPLUS1200BS40WLED840SPCWH	9405	4300.00	4 N
STOUTPLUS1200BS40WLED857SPCWH	9405	4300.00	4 N
Fixture size: (LxWxH) in (605x66x76) mm for 20 W, (1205x66x76) mm for 40 W			



STOUT MINI

Surface/Suspended LED batten, CRCA housing for efficient heat dissipation with built-in electronic driver having THD<10%.

Item Description	HSN Code	MRP Rs. Per Unit (incl. of all taxes)	Case Lot No. of unit/s
STOUTMINI1200BS20WLED865SPCWH	9405	4300.00	4 N
STOUTMINI1200BS40WLED865SPCWH	9405	4600.00	4 N
STOUTMINI1200BSGEN20WLED840SPCWH	9405	4300.00	4 N
STOUTMINI1200BSGEN20WLED857SPCWH	9405	4300.00	4 N
STOUTMINI1200BSGEN20WLED865SPCWH	9405	4300.00	4 N
STOUTMINI1200BSGEN40WLED840SPCWH	9405	4600.00	4 N
STOUTMINI1200BSGEN40WLED857SPCWH	9405	4600.00	4 N
STOUTMINI1200BSGEN40WLED865SPCWH	9405	4600.00	4 N
Fixture size: (LxWxH) in (1224x43x58) mm			



Indoor Commercial LED Luminaires

LAMPS

LED FLEXI STRIP

Flexiible LED strips with optimum brightness & uniformity of light for perfect cove lighting.

Item Description	HSN Code	MRP Rs. Per Unit (incl. of all taxes)	Case Lot No. of unit/s
FLEXISTRIP5MIP2024V/1ALED830MOD V1	9405	900.00	10 N
FLEXISTRIP5MIP2024V/1ALED840MOD V1	9405	900.00	10 N
FLEXISTRIP5MIP2024V/1ALED865MOD V1	9405	900.00	10 N
FLEXISTRIP5MIP2024V/2ALED830MOD V1	9405	1000.00	10 N
FLEXISTRIP5MIP2024V/2ALED840MOD V1	9405	1000.00	10 N
FLEXISTRIP5MIP2024V/2ALED865MOD V1	9405	1000.00	10 N
CVDRIVER24V1A	9405	500.00	20 N
CVDRIVER24V2A	9405	700.00	20 N

Fixture size: 5 m



QUADRO 2X2

A precisely designed decorative PMMA diffuser 2x2 panel light that unites a creative design with state-of-the-art LED technology. The concept of protruded decorative diffusers achieves a great sense of novelty and flexibility with multiple diffuser designs while offering perfect illumination and greater uniformity. This design stands out stunningly among the boring old modular ceiling patterns.

Item Description	HSN Code	MRP Rs. Per Unit (incl. of all taxes)	Case Lot No. of unit/s
QUADRO2X2PLR34WLED830S	9405	11000.00	2 N
QUADRO2X2PLR34WLED840S	9405	11000.00	2 N
QUADRO2X2PLR34WLED857S	9405	11000.00	2 N
QUADRO2X2PLR36WLED830S	9405	11000.00	2 N
QUADRO2X2PLR36WLED840S	9405	11000.00	2 N
QUADRO2X2PLR36WLED857S	9405	11000.00	2 N

Fixture size: (LxWxH) in (595x595x88) mm. Also available in 24 W & 28 W on request.



PETAL 2X2

A precisely designed decorative PMMA diffuser 2x2 panel light that unites a creative design with state-of-the-art LED technology. The concept of protruded decorative diffusers achieves a great sense of novelty and flexibility with multiple diffuser designs while offering perfect illumination and greater uniformity. This design stands out stunningly among the boring old modular ceiling patterns.

Item Description	HSN Code	MRP Rs. Per Unit (incl. of all taxes)	Case Lot No. of unit/s
PETAL2X2PLR34WLED830S	9405	11000.00	2 N
PETAL2X2PLR34WLED840S	9405	11000.00	2 N
PETAL2X2PLR34WLED857S	9405	11000.00	2 N
PETAL2X2PLR36WLED830S	9405	11000.00	2 N
PETAL2X2PLR36WLED840S	9405	11000.00	2 N
PETAL2X2PLR36WLED857S	9405	11000.00	2 N

Fixture size: (LxWxH) in (595x595x78) mm. Also available in 24 W & 28 W on request.



FLAT 2X2

A precisely designed decorative PMMA diffuser 2x2 panel light that unites a creative design with state-of-the-art LED technology. The concept of protruded decorative diffusers achieves a great sense of novelty and flexibility with multiple diffuser designs while offering perfect illumination and greater uniformity. This design stands out stunningly among the boring old modular ceiling patterns.

Item Description	HSN Code	MRP Rs. Per Unit (incl. of all taxes)	Case Lot No. of unit/s
DROPDOWNFLAT2X2PLR34WLED830S	9405	11000.00	2 N
DROPDOWNFLAT2X2PLR34WLED840S	9405	11000.00	2 N
DROPDOWNFLAT2X2PLR34WLED857S	9405	11000.00	2 N
DROPDOWNFLAT2X2PLR36WLED830S	9405	11000.00	2 N
DROPDOWNFLAT2X2PLR36WLED840S	9405	11000.00	2 N
DROPDOWNFLAT2X2PLR36WLED857S	9405	11000.00	2 N

Fixture size: (LxWxH) in (595x595x70) mm. Also available in 24 W & 28 W on request.

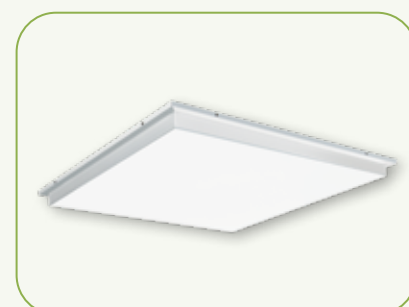

Indoor Commercial LED Luminaires

PANEL LIGHTING

VENUS NEO HE

Ultra modern designed LED luminaire which provides soft-light and glare free symmetrical illumination suitable for Armstrong/Grid ceiling.



Item Description	HSN Code	MRP Rs. Per Unit (incl. of all taxes)	Case Lot No. of unit/s
VENUSNEOHE2X2PLR18-42WLED830MOD	9405	4167.00	2 N
VENUSNEOHE2X2PLR18-42WLED840MOD	9405	4167.00	2 N
VENUSNEOHE2X2PLR18-42WLED857MOD	9405	4167.00	2 N
VENUSNEOHE2X2PLR18-42WLED865MOD	9405	4167.00	2 N
VENUSNEOHE4X1PLR28WLED857S	9405	6667.00	2 N
VENUSNEOHE4X1PLR36WLED857S	9405	6667.00	2 N
VENUSNEOHE2X2R18-42WLED830MODUGR19	9405	6333.00	2 N
VENUSNEOHE2X2R18-42WLED840MODUGR19	9405	6333.00	2 N
VENUSNEOHE2X2R18-42WLED857MODUGR<19	9405	6333.00	2 N
VENUSNEOHE2X2R34WLED830PIRSENSOR	9405	7333.00	2 N
VENUSNEOHE2X2R34WLED840PIRSENSOR	9405	7333.00	2 N
VENUSNEOHE2X2R34WLED857PIRSENSOR	9405	7333.00	2 N
VENUSNEOHE2X2R36WLED830PIRSENSOR	9405	7333.00	2 N
VENUSNEOHE2X2R36WLED840PIRSENSOR	9405	7333.00	2 N
VENUSNEOHE2X2R36WLED857PIRSENSOR	9405	7333.00	2 N
VENUSNEOTW2X2PLR42WLEDTWMOD	9405	5667.00	2 N
DRACO850RFCOMP2CH	9405	7333.00	-
DRACO1000RFCOMP2CH	9405	7667.00	-
RFREMOETWCONTROL	9405	1667.00	-
DRACO DALI 850 Digital Dimmable (DT-6)	9405	6667.00	-
DRACO DALI 1000 Digital Dimmable (DT-6)	9405	7000.00	-
LEDDRIVER36V18WS	9405	1167.00	-
LEDDRIVER36V20WS	9405	1167.00	-
LEDDRIVER36V24WS	9405	1167.00	-
LEDDRIVER36V28WS	9405	1167.00	-
LEDDRIVER36V34WS	9405	1167.00	-
LEDDRIVER36V36WS	9405	1167.00	-
LEDDRIVER36V1A42WS	9405	1333.00	-

Fixture size: (LxWxH) in (595x595x65) mm for 2x2, (1195x295x65) for 4x1

ORDERING : MODULE (MOD) + DRIVER (DRIVER TO BE ORDERED SEPARATELY)

Driver packed separately

PLANO 2X2

Ultra modern recess mounting luminaire with high performance LEDs, suitable for mounting with Armstrong/Grid ceiling.

Item Description	HSN Code	MRP Rs. Per Unit (incl. of all taxes)	Case Lot No. of unit/s
PLANO2X2PLR24WLED840S	9405	4500.00	4 N
PLANO2X2PLR24WLED857S	9405	4500.00	4 N
PLANO2X2PLR24WLED865S	9405	4500.00	4 N
PLANO2X2PLR28WLED840S	9405	4500.00	4 N
PLANO2X2PLR28WLED857S	9405	4500.00	4 N
PLANO2X2PLR28WLED865S	9405	4500.00	4 N
PLANO2X2PLR34WLED840S	9405	4500.00	4 N
PLANO2X2PLR34WLED857S	9405	4500.00	4 N
PLANO2X2PLR34WLED865S	9405	4500.00	4 N
PLANO2X2PLR36WLED840S	9405	4500.00	4 N
PLANO2X2PLR36WLED857S	9405	4500.00	4 N
PLANO2X2PLR36WLED865S	9405	4500.00	4 N
PLANO2X2PLR42WLED840S	9405	4833.00	4 N
PLANO2X2PLR42WLED857S	9405	4833.00	4 N
PLANO2X2PLR42WLED865S	9405	4833.00	4 N
PLANO2X2PLR36WLED857SPOP	9405	4703.00	4 N

Fixture size: (LxWxH) in (595x595x65) mm



VENUS NEO 2X2

Ultra modern Slim recess mounting luminaire with high performance LEDs, suitable for mounting with Armstrong/Grid ceiling (35mm height).

ST Denotes : Steel Frame. PO Denotes : Special Unibody Jointless Polymeric Frame.

AL Denotes : Aluminium Frame

Item Description	HSN Code	MRP Rs. Per Unit (incl. of all taxes)	Case Lot No. of unit/s
VENUSNEO2X2PLR36WLED857G2	9405	6300.00	6 N
VENUSNEO2X2PLR36WLED865G2	9405	6300.00	6 N
VENUSNEO2X2PLR36WLED840G2	9405	6300.00	6 N
VENUSNEO2X2PLR36WLED830G2	9405	6300.00	6 N
VENUSNEO2X2PLR36WLED857STTR	9405	4183.00	6 N
VENUSNEO2X2PLR34WLED865ST	9405	4183.00	6 N
VENUSNEO2X2PLR36WLED865ST	9405	4183.00	6 N
VENUSNEO2X2PLR36WLED857POTR	9405	4333.00	6 N
VENUSNEO2X2PLR34WLED865PO	9405	4333.00	6 N
VENUSNEO2X2PLR36WLED865PO	9405	4333.00	6 N
VENUSNEO2X2PLR36WLED830PRALMOD	9405	4600.00	6 N
VENUSNEO2X2PLR36WLED840PRALMOD	9405	4600.00	6 N
VENUSNEO2X2PLR36WLED857PRALMOD	9405	4600.00	6 N
VENUSNEO2X2PLR36WLED865PRALMOD	9405	4600.00	6 N

Fixture size: (LxWxH) in (595x595x35) mm

ORDERING : MODULE (MOD) + DRIVER (DIMMABLE DRIVER TO BE ORDERED SEPARATELY)

Driver packed separately



Indoor Commercial LED Luminaires

PANEL LIGHTING

PLUTO NEO PANEL 2X2

Environmental friendly, new generation, aesthetically designed, ultra modern recess mounting luminaire with high brightness SMD LEDs as light source, suitable for Armstrong/Grid ceiling.

Item Description	HSN Code	MRP Rs. Per Unit (incl. of all taxes)	Case Lot No. of unit/s
PLUTONEO2X2PLR28WLED840S	9405	6333.00	2 N
PLUTONEO2X2PLR28WLED857S	9405	6333.00	2 N
PLUTONEO2X2PLR34WLED840S	9405	6333.00	2 N
PLUTONEO2X2PLR34WLED857S	9405	6333.00	2 N
PLUTONEO2X2PLR42WLED840S	9405	6667.00	2 N
PLUTONEO2X2PLR42WLED857S	9405	6667.00	2 N

Fixture size: (LxWxH) in (595x595x70) mm



PLUTO NEO PANEL 4X1

Environmental friendly, new generation, aesthetically designed, ultra modern recess mounting luminaire with high brightness SMD LEDs as light source, suitable for Armstrong/Grid ceiling.

Item Description	HSN Code	MRP Rs. Per Unit (incl. of all taxes)	Case Lot No. of unit/s
PLUTONEO4X1PLR30WLED840S	9405	8333.00	2 N
PLUTONEO4X1PLR30WLED857S	9405	8333.00	2 N
PLUTONEO4X1PLR36WLED840S	9405	8333.00	2 N
PLUTONEO4X1PLR36WLED857S	9405	8333.00	2 N

Fixture size: (LxWxH) in (1195x295x70) mm



PLUTO 2X1

High efficacy 2x1 recess LED flat panel with high brightness LED for glare-free homogenous illumination. Also for POP ceilings (supplied with wedge brackets)

Item Description	HSN Code	MRP Rs. Per Unit (incl. of all taxes)	Case Lot No. of unit/s
PLUTO2X1PLR20WLED840S	9405	6000.00	2 N
PLUTO2X1PLR20WLED857S	9405	6000.00	2 N
PLUTO2X1PLR28WLED840S	9405	6000.00	2 N
PLUTO2X1PLR28WLED857S	9405	6000.00	2 N

Fixture size: (LxWxH) in (595x295x70) mm



PLUTO 1X1

High efficacy 1x1 recess LED flat panel with high brightness LED for glare-free homogenous illumination. Also for POP ceilings (supplied with wedge brackets).

Item Description	HSN Code	MRP Rs. Per Unit (incl. of all taxes)	Case Lot No. of unit/s
PLUTO1X1PLR15WLED840S	9405	3833.00	1 N
PLUTO1X1PLR15WLED857S	9405	3833.00	1 N
PLUTO1X1PLR18WLED857S	9405	4000.00	1 N
PLUTO1X1PLR24WLED857S	9405	4333.00	1 N

Fixture size: (LxWxH) in (295x295x70) mm



PLUTO PANEL (SURFACE)

Aesthetically designed 1x1, 2x2 & 4x1 LED flat panel for surface mounting which provides soft-light and glare free symmetrical illumination.

Item Description	HSN Code	MRP Rs. Per Unit (incl. of all taxes)	Case Lot No. of unit/s
PLUTOSURFACE1X1PLS15WLED840S	9405	4000.00	1 N
PLUTOSURFACE1X1PLS15WLED857S	9405	4000.00	1 N
PLUTO1X1PLS18WLED857S	9405	4333.00	1 N
PLUTO1X1PLS24WLED857S	9405	4667.00	1 N
PLUTOSURFACE2X2PLS34WLED840S	9405	7333.00	4 N
PLUTOSURFACE2X2PLS34WLED857S	9405	7333.00	4 N
PLUTOSURFACE2X2PLS42WLED840S	9405	7667.00	4 N
PLUTOSURFACE2X2PLS42WLED857S	9405	7667.00	4 N
PLUTOSURFACE4X1PLS34WLED840S	9405	8333.00	2 N
PLUTOSURFACE4X1PLS34WLED857S	9405	8333.00	2 N
PLUTOSURFACE4X1PLS42WLED840S	9405	8667.00	2 N
PLUTOSURFACE4X1PLS42WLED857S	9405	8667.00	2 N

Fixture size: (LxWxH) in (300x300x70) mm for (1x1), (600x600x70) mm for (2x2), (1160x300x70) mm for (4x1)



PLANO SURFACE

Aesthetically designed LED flat panel for surface mounting which provides soft-light and glare free symmetrical illumination.

Item Description	HSN Code	MRP Rs. Per Unit (incl. of all taxes)	Case Lot No. of unit/s
PLANOSURFACE2X2PLS28WLED857S	9405	5500.00	4 N
PLANOSUR2X2PLS34WLED857S0720	9405	5500.00	4 N
PLANOSUR2X2PLS36WLED857S0720	9405	5500.00	4 N
PLANOSUR2X2PLS42WLED857S0720	9405	5833.00	4 N
PLANOSUR4X1PLS36WLED857S0720	9405	6333.00	2 N
PLANOSUR4X1PLS42WLED857S0720	9405	6667.00	2 N

Fixture size: (LxWxH) in (560x560x65) mm for (2x2), (1120x280x65) mm for (4x1)



Indoor Commercial LED Luminaires

DOWNLIGHTS

INTEGRA NEO

Recess mounted downlighter with pressure die-cast aluminium heat sink & PC diffuser in white powder coated finish with integral electronic low THD (<10%) LED driver.

Item Description	HSN Code	MRP Rs. Per Unit (incl. of all taxes)	Case Lot No. of unit/s
INTEGRANEODLR10WLED830S	9405	1500.00	12 N
INTEGRANEODLR10WLED840S	9405	1500.00	12 N
INTEGRANEODLR10WLED857S	9405	1500.00	12 N
INTEGRANEODLR12WLED830S	9405	1867.00	8 N
INTEGRANEODLR12WLED840S	9405	1867.00	8 N
INTEGRANEODLR12WLED857S	9405	1867.00	8 N
INTEGRANEODLR15WLED830S	9405	2067.00	8 N
INTEGRANEODLR15WLED840S	9405	2067.00	8 N
INTEGRANEODLR15WLED857S	9405	2067.00	8 N
INTEGRANEODLR15WLED865S	9405	2067.00	8 N
INTEGRANEODLR18WLED830S	9405	2567.00	6 N
INTEGRANEODLR18WLED840S	9405	2567.00	6 N
INTEGRANEODLR18WLED857S	9405	2567.00	6 N
INTEGRANEODLR18WLED865S	9405	2567.00	6 N
INTEGRANEODLR24WLED830S	9405	2733.00	6 N
INTEGRANEODLR24WLED840S	9405	2733.00	6 N
INTEGRANEODLR24WLED857S	9405	2733.00	6 N
INTEGRANEODLR24WLED865S	9405	2733.00	6 N
INTEGRANEODLR42V400MALED840MOD	9405	1433.00	8 N
INTEGRANEODLR42V400MALED857MOD	9405	1433.00	8 N
DALIDRIVERSQ10-50V/350MA10161105	9405	7000.00	-
DALIDRIVERSQ10-50V/300MA10181251	9405	7000.00	-

Ceiling cutout: Ø 90 mm, height 90 mm for 10 W. Ø 138 mm, height 90 mm for 12 W/15 W
Ceiling cutout: Ø 175 mm, height 90 mm for 18 W/24 W



INTEGRA GRAND

Recess mounted downlighter with pressure die-cast aluminium heat sink & PC diffuser in white powder coated finish with integrated driver.

Item Description	HSN Code	MRP Rs. Per Unit (incl. of all taxes)	Case Lot No. of unit/s
INTEGRAGRANDDL10WLED830S	9405	2000.00	12 N
INTEGRAGRANDDL10WLED840S	9405	2000.00	12 N
INTEGRAGRANDDL10WLED857S	9405	2000.00	12 N
INTEGRAGRANDDL10WLED865S	9405	2000.00	12 N
INTEGRAGRANDDL15WLED840S	9405	2500.00	12 N
INTEGRAGRANDDL15WLED857S	9405	2500.00	12 N
INTEGRAGRANDDL15WLED865S	9405	2500.00	12 N

Ceiling cutout: Ø 175 mm, height 92 mm



INTEGRA NXT

Recessed mounted Downlight with Low depth Aluminium (99% Purity) Heat Sink, available in Round and Square shape. PC diffuser in white powder coated finish with independent electronic low THD (<10%) LED driver.



Item Description	HSN Code	MRP Rs. Per Unit (incl. of all taxes)	Case Lot No. of unit/s
INTEGRANXTDLR9WLED857S	9405	1420.00	12 N
INTEGRANXTDLR9WLED865S	9405	1420.00	12 N
INTEGRANXTDLR12WLED857S	9405	1587.00	12 N
INTEGRANXTDLR12WLED865S	9405	1587.00	12 N
INTEGRANXTDLR15WLED857S	9405	1660.00	12 N
INTEGRANXTDLR15WLED865S	9405	1660.00	12 N
INTEGRANXTDLR18WLED857S	9405	1700.00	12 N
INTEGRANXTDLR18WLED865S	9405	1700.00	12 N
INTEGRANXTDLSQ9WLED857S	9405	1420.00	12 N
INTEGRANXTDLSQ9WLED865S	9405	1420.00	12 N
INTEGRANXTDLSQ12WLED857S	9405	1587.00	12 N
INTEGRANXTDLSQ12WLED865S	9405	1587.00	12 N
INTEGRANXTDLSQ15WLED857S	9405	1660.00	12 N
INTEGRANXTDLSQ15WLED865S	9405	1660.00	12 N
INTEGRANXTDLSQ18WLED857S	9405	1700.00	12 N
INTEGRANXTDLSQ18WLED865S	9405	1700.00	12 N
INTEGRANXTDLRD9WLED830S	9405	1420.00	12 N
INTEGRANXTDLRD9WLED840S	9405	1420.00	12 N
INTEGRANXTDLRD12WLED830S	9405	1587.00	12 N
INTEGRANXTDLRD12WLED840S	9405	1587.00	12 N
INTEGRANXTDLRD15WLED830S	9405	1660.00	12 N
INTEGRANXTDLRD15WLED840S	9405	1660.00	12 N
INTEGRANXTDLRD18WLED830S	9405	1700.00	12 N
INTEGRANXTDLRD18WLED840S	9405	1700.00	12 N
INTEGRANXTDLSQ9WLED830S	9405	1420.00	12 N
INTEGRANXTDLSQ9WLED840S	9405	1420.00	12 N
INTEGRANXTDLSQ12WLED830S	9405	1587.00	12 N
INTEGRANXTDLSQ12WLED840S	9405	1587.00	12 N
INTEGRANXTDLSQ15WLED830S	9405	1660.00	12 N
INTEGRANXTDLSQ15WLED840S	9405	1660.00	12 N
INTEGRANXTDLSQ18WLED830S	9405	1700.00	12 N
INTEGRANXTDLSQ18WLED840S	9405	1700.00	12 N
INTEGRANXTDLR9WLED857S TR	9405	1420.00	12 N
INTEGRANXTDLSQ9WLED857S TR	9405	1420.00	12 N
INTEGRANXTDLR12WLED857S TR	9405	1587.00	12 N
INTEGRANXTDLSQ12WLED857S TR	9405	1587.00	12 N
INTEGRANXTDLR15WLED857S TR	9405	1660.00	12 N
INTEGRANXTDLSQ15WLED857S TR	9405	1660.00	12 N
INTEGRANXTDLR18WLED857S TR	9405	1700.00	12 N
INTEGRANXTDLSQ18WLED857S TR	9405	1700.00	12 N

Ceiling cutout: Ø 110 mm, height 40 mm for 9 W. Ø 145 mm, height 40 mm for 12 W/15 W/18 W
 Ceiling cutout: (LxWxH) in (110x110x45) mm for 9 W. (145x145x48) mm for 12 W/15 W/18 W

Indoor Commercial LED Luminaires

DOWNLIGHTS

INTEGRA PLUS

Recessed mounted Downlight with Low depth Aluminium (99% Purity) Heat Sink, available in Round and Square shape. PC diffuser in white powder coated finish with independent electronic low THD (<10%) LED driver with higher design life class.

Item Description	HSN Code	MRP Rs. Per Unit (incl. of all taxes)	Case Lot No. of unit/s
INTEGRAPLUSDLRD9WLED830	9405	1600.00	6 N
INTEGRAPLUSDLRD9WLED840	9405	1600.00	6 N
INTEGRAPLUSDLRD9WLED857	9405	1600.00	6 N
INTEGRAPLUSDLRD9WLED865	9405	1600.00	6 N
INTEGRAPLUSDLSQ9WLED830	9405	1600.00	6 N
INTEGRAPLUSDLSQ9WLED840	9405	1600.00	6 N
INTEGRAPLUSDLSQ9WLED857	9405	1600.00	6 N
INTEGRAPLUSDLSQ9WLED865	9405	1600.00	6 N
INTEGRAPLUSDLRD12WLED830	9405	1850.00	6 N
INTEGRAPLUSDLRD12WLED840	9405	1850.00	6 N
INTEGRAPLUSDLRD12WLED857	9405	1850.00	6 N
INTEGRAPLUSDLRD12WLED865	9405	1850.00	6 N
INTEGRAPLUSDLSQ12WLED830	9405	1850.00	6 N
INTEGRAPLUSDLSQ12WLED840	9405	1850.00	6 N
INTEGRAPLUSDLSQ12WLED857	9405	1850.00	6 N
INTEGRAPLUSDLSQ12WLED865	9405	1850.00	6 N
INTEGRAPLUSDLRD15WLED830	9405	1950.00	6 N
INTEGRAPLUSDLRD15WLED840	9405	1950.00	6 N
INTEGRAPLUSDLRD15WLED857	9405	1950.00	6 N
INTEGRAPLUSDLRD15WLED865	9405	1950.00	6 N
INTEGRAPLUSDLSQ15WLED830	9405	1950.00	6 N
INTEGRAPLUSDLSQ15WLED840	9405	1950.00	6 N
INTEGRAPLUSDLSQ15WLED857	9405	1950.00	6 N
INTEGRAPLUSDLSQ15WLED865	9405	1950.00	6 N
INTEGRAPLUSDLRD18WLED830	9405	2050.00	6 N
INTEGRAPLUSDLRD18WLED840	9405	2050.00	6 N
INTEGRAPLUSDLRD18WLED857	9405	2050.00	6 N
INTEGRAPLUSDLRD18WLED865	9405	2050.00	6 N
INTEGRAPLUSDLSQ18WLED830	9405	2050.00	6 N
INTEGRAPLUSDLSQ18WLED840	9405	2050.00	6 N
INTEGRAPLUSDLSQ18WLED857	9405	2050.00	6 N
INTEGRAPLUSDLSQ18WLED865	9405	2050.00	6 N

Ceiling cutout: Ø 110 mm, height 40 mm for 9 W. Ø 145 mm, height 40 mm for 12 W/15 W/18 W
Ceiling cutout: (LxWxH) in (110x110x45) mm for 9 W. (145x145x48) mm for 12 W/15 W/18 W



INTEGRA HE

Recess mounted downlighter with pressure die-cast aluminium heat sink & PC diffuser in white powder coated finish with integral electronic low THD (<10%) LED driver.

Item Description	HSN Code	MRP Rs. Per Unit (incl. of all taxes)	Case Lot No. of unit/s
INTEGRAHEDLR7WLED857S	9405	1667.00	12 N
INTEGRAHEDLR12WLED857S	9405	2167.00	12 N
INTEGRAHEDLR15WLED857S	9405	2267.00	8 N
INTEGRAHEDLR18WLED857S	9405	2767.00	6 N

Ceiling cutout: Ø 138 mm, height 90 mm for 7 W/12 W/15 W. Ø 175 mm, height 90 mm for 18 W



EDGEPRO NEO ROUND

Elegantly designed sleek recessed mounted pressure die-cast aluminium luminaire in powder coated white finish in round profile with optimized heat sink for efficient heat dissipation and independent electronic LED driver.

Item Description	HSN Code	MRP Rs. Per Unit (incl. of all taxes)	Case Lot No. of unit/s
EDGEPRONEORDDL10WLED840S	9405	1700.00	12 N
EDGEPRONEORDDL10WLED857S	9405	1700.00	12 N
EDGEPRONEORDDL10WLED865S	9405	1700.00	12 N
EDGEPRONEORDDL12WLED840S	9405	1900.00	12 N
EDGEPRONEORDDL12WLED857S	9405	1900.00	12 N
EDGEPRONEORDDL12WLED865S	9405	1900.00	12 N
EDGEPRONEORDDL15WLED840S	9405	2100.00	12 N
EDGEPRONEORDDL15WLED857S	9405	2100.00	12 N
EDGEPRONEORDDL15WLED865S	9405	2100.00	12 N
EDGEPRONEORDDL18WLED840S	9405	2500.00	12 N
EDGEPRONEORDDL18WLED857S	9405	2500.00	12 N
EDGEPRONEORDDL18WLED865S	9405	2500.00	12 N

Ceiling cutout: Ø 135 mm, height 17.5 mm for 10 W. Ø 156 mm, height 17.5 mm for 12 W. Ø 155 mm, height 17.5 mm for 15 W. Ø 180 mm, height 22 mm for 18 W.



EDGEPRO NEO SQUARE

Elegantly designed sleek recessed mounted pressure die-cast aluminium luminaire in powder coated white finish in square profile with optimized heat sink for efficient heat dissipation and independent electronic LED driver.

Item Description	HSN Code	MRP Rs. Per Unit (incl. of all taxes)	Case Lot No. of unit/s
EDGEPRONEOSQDLR10WLED840S	9405	1700.00	12 N
EDGEPRONEOSQDLR10WLED857S	9405	1700.00	12 N
EDGEPRONEOSQDLR10WLED865S	9405	1700.00	12 N
EDGEPRONEOSQDLR12WLED840S	9405	1900.00	12 N
EDGEPRONEOSQDLR12WLED857S	9405	1900.00	12 N
EDGEPRONEOSQDLR12WLED865S	9405	1900.00	12 N
EDGEPRONEOSQDLR15WLED840S	9405	2100.00	12 N
EDGEPRONEOSQDLR15WLED857S	9405	2100.00	12 N
EDGEPRONEOSQDLR15WLED865S	9405	2100.00	12 N
EDGEPRONEOSQDLR18WLED840S	9405	2500.00	12 N
EDGEPRONEOSQDLR18WLED857S	9405	2500.00	12 N
EDGEPRONEOSQDLR18WLED865S	9405	2500.00	12 N

Ceiling cutout: 135x135 mm, height 17.5 mm for 10 W. 156x156 mm, height 17.5 mm for 12 W. 155x155 mm, height 17.5 mm for 15 W. 175x175 mm, height 22 mm for 18 W.



Indoor Commercial LED Luminaires

DOWNLIGHTS

ENDURA HO

Endura HO is a highly efficient downlight with efficacy of 100 lm/W. With its IP44 rating, the range is perfect for corridors, WCs, high public circulation areas and reception areas. EMI /EMC, CE Compliant Product.

Item Description	HSN Code	MRP Rs. Per Unit (incl. of all taxes)	Case Lot No. of unit/s
ENDURAHODLR12WLED830MOD	9405	1333.00	12 N
ENDURAHODLR12WLED857MOD	9405	1333.00	12 N
LEDDRIVER12/15WENDURAHOC	9405	1000.00	20 N
ENDURAHODLR15WLED830MOD	9405	1433.00	12 N
ENDURAHODLR15WLED857MOD	9405	1433.00	12 N
ENDURAHODLR21WLED830MOD	9405	1667.00	12 N
ENDURAHODLR21WLED857MOD	9405	1667.00	12 N
LEDDRIVER21/25WENDURAHOC	9405	1067.00	20 N
ENDURAHODLR25WLED830MOD	9405	2000.00	12 N
ENDURAHODLR25WLED857MOD	9405	2000.00	12 N

Ceiling cutout: Ø 145 mm, height 45 mm for 12 W. Ø 175 mm, height 55 mm for 15 W

Ceiling cutout: Ø 205 mm, height 60 mm for 21 W. Ø 225 mm, height 65 mm for 25 W

ORDERING : MODULE (MOD) + DRIVER (DRIVER TO BE ORDERED SEPARATELY)

Driver packed separately



GLOW

Recess mounted Downlighter with PC housing & Opal PC diffuser with Independent electronic LED driver.

Item Description	HSN Code	MRP Rs. Per Unit (incl. of all taxes)	Case Lot No. of unit/s
GLOWDLR10WLED830S	9405	2000.00	12 N
GLOWDLR10WLED840S	9405	2000.00	12 N
GLOWDLR10WLED857S	9405	2000.00	20 N
GLOWDLR12WLED830S	9405	2300.00	12 N
GLOWDLR12WLED840S	9405	2300.00	12 N
GLOWDLR12WLED857S	9405	2300.00	12 N
GLOWDLR15WLED830S	9405	2600.00	12 N
GLOWDLR15WLED840S	9405	2600.00	20 N
GLOWDLR15WLED857S	9405	2600.00	12 N
GLOWDLR18WLED830S	9405	3000.00	12 N
GLOWDLR18WLED840S	9405	3000.00	12 N
GLOWDLR18WLED857S	9405	3000.00	12 N

Ceiling cutout: Ø 165 mm, height 36 mm for 10 W/12 W/15 W. Ø 220 mm, height 36 mm for 18 W



INTEGRA NXT SURFACE ROUND

Surface mounted Downlight with Aluminium (99% Purity) Sink, available in Round shape. PC diffuser in white powder coated finish with built in electronic low THD (<10%) LED driver.

Item Description	HSN Code	MRP Rs. Per Unit (incl. of all taxes)	Case Lot No. of unit/s
INTEGRANXTRDDLRSURD9WLED830S	9405	1850.00	12 N
INTEGRANXTRDDLRSURD9WLED840S	9405	1850.00	12 N
INTEGRANXTRDDLRSURD9WLED857S	9405	1850.00	12 N
INTEGRANXTRDDLRSURD9WLED865S	9405	1850.00	12 N
INTEGRANXTRDDLRSURD12WLED830S	9405	1950.00	12 N
INTEGRANXTRDDLRSURD12WLED840S	9405	1950.00	12 N
INTEGRANXTRDDLRSURD12WLED857S	9405	1950.00	12 N
INTEGRANXTRDDLRSURD12WLED865S	9405	1950.00	12 N
INTEGRANXTRDDLRSURD15WLED830S	9405	2050.00	12 N
INTEGRANXTRDDLRSURD15WLED840S	9405	2050.00	12 N
INTEGRANXTRDDLRSURD15WLED857S	9405	2050.00	12 N
INTEGRANXTRDDLRSURD15WLED865S	9405	2050.00	12 N
INTEGRANXTRDDLRSURD18WLED830S	9405	2150.00	12 N
INTEGRANXTRDDLRSURD18WLED840S	9405	2150.00	12 N
INTEGRANXTRDDLRSURD18WLED857S	9405	2150.00	12 N
INTEGRANXTRDDLRSURD18WLED865S	9405	2150.00	12 N
INTEGRANXTRDDLRSURD24WLED840S	9405	2250.00	6 N
INTEGRANXTRDDLRSURD24WLED830S	9405	2250.00	6 N
INTEGRANXTRDDLRSURD24WLED857S	9405	2250.00	6 N
INTEGRANXTRDDLRSURD24WLED865S	9405	2250.00	6 N

Fixture size: Ø 167 mm, Height 56 mm for 9 W. Ø 170 mm, Height 58 mm for 12 W/15 W/18 W. Ø 210 mm, Height 65 mm for 24 W.



INTEGRA NXT SURFACE SQUARE

Surface mounted Downlight with Aluminium (99% Purity) Sink, available in Square shape. PC diffuser in white powder coated finish with built in electronic low THD (<10%) LED driver.

Item Description	HSN Code	MRP Rs. Per Unit (incl. of all taxes)	Case Lot No. of unit/s
INTEGRANXTSQDLRSURD9WLED830S	9405	1900.00	12 N
INTEGRANXTSQDLRSURD9WLED840S	9405	1900.00	12 N
INTEGRANXTSQDLRSURD9WLED857S	9405	1900.00	12 N
INTEGRANXTSQDLRSURD9WLED865S	9405	1900.00	12 N
INTEGRANXTSQDLRSURD12WLED830S	9405	2000.00	12 N
INTEGRANXTSQDLRSURD12WLED840S	9405	2000.00	12 N
INTEGRANXTSQDLRSURD12WLED857S	9405	2000.00	12 N
INTEGRANXTSQDLRSURD12WLED865S	9405	2000.00	12 N
INTEGRANXTSQDLRSURD15WLED830S	9405	2100.00	12 N
INTEGRANXTSQDLRSURD15WLED840S	9405	2100.00	12 N
INTEGRANXTSQDLRSURD15WLED857S	9405	2100.00	12 N
INTEGRANXTSQDLRSURD15WLED865S	9405	2100.00	12 N
INTEGRANXTSQDLRSURD18WLED830S	9405	2200.00	12 N
INTEGRANXTSQDLRSURD18WLED840S	9405	2200.00	12 N
INTEGRANXTSQDLRSURD18WLED857S	9405	2200.00	12 N
INTEGRANXTSQDLRSURD18WLED865S	9405	2200.00	12 N
INTEGRANXTSQDLRSURD24WLED830S	9405	2300.00	6 N
INTEGRANXTSQDLRSURD24WLED840S	9405	2300.00	6 N
INTEGRANXTSQDLRSURD24WLED857S	9405	2300.00	6 N
INTEGRANXTSQDLRSURD24WLED865S	9405	2300.00	6 N

Fixture size: (LxWxH) in (150x150x56) mm for 9 W. (LxWxH) in (170x170x58) mm for 12 W/15 W/18 W. (LxWxH) in (210x210x65) mm for 24 W.



Indoor Commercial LED Luminaires

DOWNLIGHTS

EDGEPRO SURFACE ROUND

Elegantly designed sleek surface mounted pressure die-cast aluminium luminaire in powder coated white finish in round profile with optimized heat sink for efficient heat dissipation and independent electronic LED driver.

Item Description	HSN Code	MRP Rs. Per Unit (incl. of all taxes)	Case Lot No. of unit/s
EDGESURFACERDDL12WLED840S	9405	2000.00	12 N
EDGESURFACERDDL12WLED857S	9405	2000.00	12 N
EDGESURFACERDDL12WLED865S	9405	2000.00	12 N
EDGESURFACERDDL15WLED840S	9405	2500.00	12 N
EDGESURFACERDDL15WLED857S	9405	2500.00	12 N
EDGESURFACERDDL15WLED865S	9405	2500.00	12 N
EDGESURFACERDDL18WLED840S	9405	3000.00	12 N
EDGESURFACERDDL18WLED857S	9405	3000.00	12 N
EDGESURFACERDDL18WLED865S	9405	3000.00	12 N

Fixture size: Ø 175 mm, Height 35 mm



EDGEPRO SURFACE SQUARE

Elegantly designed sleek surface mounted pressure die-cast aluminium luminaire in powder coated white finish in square profile with optimized heat sink for efficient heat dissipation and independent electronic LED driver.

Item Description	HSN Code	MRP Rs. Per Unit (incl. of all taxes)	Case Lot No. of unit/s
EDGESURFACESQDL12WLED840S	9405	2000.00	12 N
EDGESURFACESQDL12WLED857S	9405	2000.00	12 N
EDGESURFACESQDL12WLED865S	9405	2000.00	12 N
EDGESURFACESQDL15WLED840S	9405	2500.00	12 N
EDGESURFACESQDL15WLED857S	9405	2500.00	12 N
EDGESURFACESQDL15WLED865S	9405	2500.00	12 N
EDGESURFACESQDL18WLED840S	9405	3000.00	12 N
EDGESURFACESQDL18WLED857S	9405	3000.00	12 N
EDGESURFACESQDL18WLED865S	9405	3000.00	12 N

Fixture size: (LxWxH) in (175x175x35) mm for 12 W/15 W. (LxWxH) in (225x225x35) mm for 18 W.



ENDURA NEO HE DL SURFACE

Surface mounted LED downlighter with white powder coated aluminium housing with integrated electronic driver.

Item Description	HSN Code	MRP Rs. Per Unit (incl. of all taxes)	Case Lot No. of unit/s
ENDURANEOSURFACEDLS15WLED857S	9405	3000.00	10 N
ENDURANEOSURFACEDLS18WLED857S	9405	3167.00	10 N
ENDURANEOSURFACEDLS21WLED857S	9405	3333.00	10 N

Fixture size: Ø 234 mm, Height 57 mm



INTEGRA NEO (SURFACE)

Surface mounted downlight with white powder coated polycarbonate decorative housing and pressure die-cast heat sink having high efficiency with heavy duty driver having THD<10%.

Item Description	HSN Code	MRP Rs. Per Unit (incl. of all taxes)	Case Lot No. of unit/s
INTEGRANEOSURFACEDLS10WLED830S	9405	2117.00	12 N
INTEGRANEOSURFACEDLS10WLED840S	9405	2117.00	12 N
INTEGRANEOSURFACEDLS10WLED857S	9405	2167.00	12 N
INTEGRANEOSURFACEDLS10WLED865S	9405	2167.00	12 N
INTEGRANEOSURFACEDLS15WLED830S	9405	2233.00	12 N
INTEGRANEOSURFACEDLS15WLED840S	9405	2233.00	12 N
INTEGRANEOSURFACEDLS15WLED857S	9405	2233.00	12 N
INTEGRANEOSURFACEDLS15WLED865S	9405	2233.00	12 N

Fixture size: Ø 200 mm, Height 69 mm



GLOW (SURFACE)

Surface mounted Downlighter with ABS housing & PC Opal diffuser with integral electronic LED driver.

Item Description	HSN Code	MRP Rs. Per Unit (incl. of all taxes)	Case Lot No. of unit/s
GLOWDLS10WLED830S	9405	2300.00	12 N
GLOWDLS10WLED840S	9405	2300.00	12 N
GLOWDLS10WLED857S	9405	2300.00	12 N
GLOWDLS15WLED830S	9405	2800.00	12 N
GLOWDLS15WLED840S	9405	2800.00	12 N
GLOWDLS15WLED857S	9405	2800.00	12 N
GLOWGENXDLS18WLED857S	9405	3200.00	12 N

Fixture size: Ø 185 mm, Height 45 mm



Indoor Commercial LED Luminaires

DOWNLIGHTS

SPARKLE PRO FIX

Recess mounted fixed LED downlight made of extruded Aluminium housing and high power LED as a light source with clear diffuser and separate electronic driver.

Item Description	HSN Code	MRP Rs. Per Unit (incl. of all taxes)	Case Lot No. of unit/s
SPARKLEPROFIXDLR8W830MOD40DWHTNEEM	9405	1333.00	30 N
SPARKLEPROFIXDLR8W840MOD40DWHTNEEM	9405	1333.00	30 N
SPARKLEPROFIXDLR8W857MOD40DWHTNEEM	9405	1333.00	30 N
Non- Dimable driver for above	9405	833.00	20 N
Dimable DALI driver for above	9405	On Request	30 N
SPARKLEPROFIXDLR12W830MOD40DWHTNEEM	9405	2000.00	30 N
SPARKLEPROFIXDLR12W840MOD40DWHTNEEM	9405	2000.00	30 N
SPARKLEPROFIXDLR12W857MOD40DWHTNEEM	9405	2000.00	30 N
Non- Dimable driver for above	9405	1000.00	20 N
Dimable DALI driver for above	9405	On Request	30 N
SPARKLEPROFIXDLR20W830MOD40DWHTNEEM	9405	2833.00	8 N
SPARKLEPROFIXDLR20W840MOD40DWHTNEEM	9405	2833.00	8 N
SPARKLEPROFIXDLR20W857MOD40DWHTNEEM	9405	2833.00	8 N
Non- Dimable driver for above	9405	1500.00	20 N
Dimable DALI driver for above	9405	On Request	30 N
SPARKLEPROFIXDLR30W830MOD40DWHTNEEM	9405	5000.00	8 N
SPARKLEPROFIXDLR30W840MOD40DWHTNEEM	9405	5000.00	8 N
SPARKLEPROFIXDLR30W857MOD40DWHTNEEM	9405	5000.00	8 N
Non- Dimable driver for above	9405	1667.00	20 N
Dimable DALI driver for above	9405	On Request	30 N
SPARKLEPROFIXDLR45W830MOD60DWHTNEEM	9405	6000.00	8 N
SPARKLEPROFIXDLR45W840MOD60DWHTNEEM	9405	6000.00	8 N
SPARKLEPROFIXDLR45W857MOD60DWHTNEEM	9405	6000.00	8 N
Non- Dimable driver for above	9405	1500.00	20 N
Dimable DALI driver for above	9405	On Request	30 N

Ceiling cutout: Ø 80 mm, height 50 mm for 8 W. Ceiling cutout: Ø 105 mm, height 65 mm for 12 W
 Ceiling cutout: Ø 128 mm, height 80 mm for 20 W. Ceiling cutout: Ø 183 mm, height 105 mm for 30 W
 Ceiling cutout: Ø 205 mm, height 117 mm for 45 W
ORDERING : MODULE (MOD) + DRIVER (DRIVER TO BE ORDERED SEPARATELY)
Driver packed separately



SPARKLE PRO DL

Recess mounting downlighter with pressure die-cast aluminium housing & high power Discrete LED used as light source.

Item Description	HSN Code	MRP Rs. Per Unit (incl. of all taxes)	Case Lot No. of unit/s
SPARKLEPROFIXDLR50WLED857S60DWHT	9405	On Request	1 N
SPARKLEPROFIXDLR60WLED857S60DWHT	9405	On Request	1 N
SPARKLEPROFIXDLR70WLED857S60DWHT	9405	On Request	1 N
SPARKLEPROFIXDLR50WLED857S90DWHT	9405	On Request	1 N
SPARKLEPROFIXDLR60WLED857S90DWHT	9405	On Request	1 N
SPARKLEPROFIXDLR70WLED857S90DWHT	9405	On Request	1 N

Ceiling cutout: Ø 240 mm, height 209 mm



SPARKLE PRO ADJUSTABLE

Recess mounted adjustable LED downlights made of extruded Aluminium housing and high power LED as a light source with clear diffuser and separate electronic driver.

Item Description	HSN Code	MRP Rs. Per Unit (incl. of all taxes)	Case Lot No. of unit/s
SPARKLEPROADJDLR8W830MOD40DWHTEEM	9405	1500.00	30 N
SPARKLEPROADJDLR8W840MOD40DWHTEEM	9405	1500.00	30 N
SPARKLEPROADJDLR8W857MOD40DWHTEEM	9405	1500.00	30 N
Non- Dimable driver for above	9405	833.00	20 N
Dimable DALI driver for above	9405	On Request	30 N
SPARKLEPROADJDLR12W830MOD40DWHTEEM	9405	2167.00	30 N
SPARKLEPROADJDLR12W840MOD40DWHTEEM	9405	2167.00	30 N
SPARKLEPROADJDLR12W857MOD40DWHTEEM	9405	2167.00	30 N
Non- Dimable driver for above	9405	1000.00	20 N
Dimable DALI driver for above	9405	On Request	30 N
SPARKLEPROADJDLR20W830MOD40DWHTEEM	9405	3000.00	20 N
SPARKLEPROADJDLR20W840MOD40DWHTEEM	9405	3000.00	20 N
SPARKLEPROADJDLR20W857MOD40DWHTEEM	9405	3000.00	20 N
Non- Dimable driver for above	9405	1500.00	20 N
Dimable DALI driver for above	9405	On Request	30 N
SPARKLEPROADJDLR30W830MOD40DWHTEEM	9405	5167.00	10 N
SPARKLEPROADJDLR30W840MOD40DWHTEEM	9405	5167.00	10 N
SPARKLEPROADJDLR30W857MOD40DWHTEEM	9405	5167.00	10 N
SPARKLEPROADJDLR30W840MOD40DBLKNEEM	9405	5167.00	10 N
Non- Dimable driver for above	9405	1667.00	20 N
Dimable DALI driver for above	9405	On Request	30 N

Ceiling cutout: Ø 75 mm, height 62 mm for 8 W. Ceiling cutout: Ø 90 mm, height 75 mm for 12 W
 Ceiling cutout: Ø 120 mm, height 90 mm for 20 W. Ceiling cutout: Ø 142 mm, height 98 mm for 30 W
ORDERING : MODULE (MOD) + DRIVER (DRIVER TO BE ORDERED SEPARATELY)
Driver packed separately



SPARKLE PRO SNOOT

Recess mounted LED wall washers, tilted 70° outwards and swivels 360° to offer best illumination on the wall and retail displays.

Item Description	HSN Code	MRP Rs. Per Unit (incl. of all taxes)	Case Lot No. of unit/s
SPARKLEPROSNOOTDLR20W830MOD30DWHTEEM	9405	4000.00	18 N
SPARKLEPROSNOOTDLR20W840MOD30DWHTEEM	9405	4000.00	18 N
SPARKLEPROSNOOTDLR20W857MOD30DWHTEEM	9405	4000.00	18 N
Driver for above	9405	1500.00	20 N
SPARKLEPROSNOOTDLR30W830MOD38DWHTEEM	9405	4667.00	12 N
SPARKLEPROSNOOTDLR30W840MOD38DWHTEEM	9405	4667.00	12 N
SPARKLEPROSNOOTDLR30W857MOD38DWHTEEM	9405	4667.00	12 N
Driver for above	9405	1667.00	20 N

Ceiling cutout: Ø 140 mm, height 140 mm for 20 W. Ceiling cutout: Ø 175 mm, height 170 mm for 30 W
ORDERING : MODULE (MOD) + DRIVER (DRIVER TO BE ORDERED SEPARATELY)
Driver packed separately



Indoor Commercial LED Luminaires

DOWNLIGHTS

UNECO FIXED DOWN LIGHT

New generation, energy saving, aesthetically designed, recessed mounted down light pressure die-cast aluminum heat sink & high efficiency long life COB LED mounted on MCPCB with high efficacy of 140 lm/W used for enhanced lumen output.

Item Description	HSN Code	MRP Rs. Per Unit (incl. of all taxes)	Case Lot No. of unit/s
UNECOFIXDLR8WLED830S60	9405	1888.00	20 N
UNECOFIXDLR8WLED840S60	9405	1888.00	20 N
UNECOFIXDLR8WLED857S60	9405	1888.00	20 N
UNECOFIXDLR12WLED830S60	9405	2232.00	20 N
UNECOFIXDLR12WLED840S60	9405	2232.00	20 N
UNECOFIXDLR12WLED857S60	9405	2232.00	20 N
UNECOFIXDLR15WLED830S60	9405	2609.00	20 N
UNECOFIXDLR15WLED840S60	9405	2609.00	20 N
UNECOFIXDLR15WLED857S60	9405	2609.00	20 N
UNECOFIXDLR20WLED830S60	9405	3622.00	10 N
UNECOFIXDLR20WLED840S60	9405	3622.00	10 N
UNECOFIXDLR20WLED857S60	9405	3622.00	10 N
UNECOFIXDLR30WLED830S60	9405	5081.00	10 N
UNECOFIXDLR30WLED840S60	9405	5081.00	10 N
UNECOFIXDLR30WLED857S60	9405	5081.00	10 N
UNECOFIXDLR40WLED830S40	9405	7138.00	10 N
UNECOFIXDLR40WLED840S40	9405	7138.00	10 N
UNECOFIXDLR40WLED857S40	9405	7138.00	10 N

Ceiling cutout: Ø 70 mm, height 40 mm for 8 W. Ceiling cutout: Ø 80 mm, height 41 mm for 12 W
 Ceiling cutout: Ø 90 mm, height 41 mm for 15 W. Ceiling cutout: Ø 110 mm, height 51 mm for 20 W
 Ceiling cutout: Ø 160 mm, height 53 mm for 30 W. Ceiling cutout: Ø 190 mm, height 57 mm for 40 W



UNECO ADJUSTABLE SPOT LIGHT

New generation, energy saving, aesthetically designed, recessed mounted down light pressure die-cast aluminum heat sink & high efficiency long life COB LED mounted on MCPCB with high efficacy of 140 lm/W used for enhanced lumen output.

Item Description	HSN Code	MRP Rs. Per Unit (incl. of all taxes)	Case Lot No. of unit/s
UNECOADJDLR8WLED830S24	9405	2232.00	20 N
UNECOADJDLR8WLED840S24	9405	2232.00	20 N
UNECOADJDLR8WLED857S24	9405	2232.00	20 N
UNECOADJDLR12WLED830S24	9405	2582.00	20 N
UNECOADJDLR12WLED840S24	9405	2582.00	20 N
UNECOADJDLR12WLED857S24	9405	2582.00	20 N
UNECOADJDLR15WLED830S24	9405	2936.00	20 N
UNECOADJDLR15WLED840S24	9405	2936.00	20 N
UNECOADJDLR15WLED857S24	9405	2936.00	20 N
UNECOADJDLR20WLED830S36	9405	3948.00	10 N
UNECOADJDLR20WLED840S36	9405	3948.00	10 N
UNECOADJDLR20WLED857S36	9405	3948.00	10 N
UNECOADJDLR30WLED830S36	9405	5322.00	10 N
UNECOADJDLR30WLED840S36	9405	5322.00	10 N
UNECOADJDLR30WLED857S36	9405	5322.00	10 N

Ceiling cutout: Ø 75 mm, height 50 mm for 8 W. Ceiling cutout: Ø 75 mm, height 50 mm for 12 W
 Ceiling cutout: Ø 95 mm, height 67 mm for 15 W. Ceiling cutout: Ø 120 mm, height 83 mm for 20 W
 Ceiling cutout: Ø 140 mm, height 90 mm for 30 W



UNECO SNOOT

Recess mounted LED wall washers, tilted 70° outwards and swivels 350° to offer best illumination on the wall and retail displays.

Item Description	HSN Code	MRP Rs. Per Unit (incl. of all taxes)	Case Lot No. of unit/s
UNECOSNOOTDLR8WLED830S36	9405	2000.00	20 N
UNECOSNOOTDLR8WLED840S36	9405	2000.00	20 N
UNECOSNOOTDLR8WLED857S36	9405	2000.00	20 N
UNECOSNOOTDLR15WLED830S36	9405	3140.00	20 N
UNECOSNOOTDLR15WLED840S36	9405	3140.00	20 N
UNECOSNOOTDLR15WLED857S36	9405	3140.00	20 N
UNECOSNOOTDLR25WLED830S36	9405	4830.00	10 N
UNECOSNOOTDLR25WLED840S36	9405	4830.00	10 N
UNECOSNOOTDLR25WLED857S36	9405	4830.00	10 N

Ceiling cutout: Ø 80 mm, height 70 mm for 8 W. Ceiling cutout: Ø 95 mm, height 76 mm for 15 W
Ceiling cutout: Ø 120 mm, height 97 mm for 15 W

ORDERING : MODULE (MOD) + DRIVER (DRIVER TO BE ORDERED SEPARATELY)
Driver packed separately



UNECO BRITE SPOT LIGHT

Deep recessed antiglare LED Spot down light for general and accent lighting. The premium reflector matches the ceiling and accentuates the architecture of the area without compromising the light output.

Item Description	HSN Code	MRP Rs. Per Unit (incl. of all taxes)	Case Lot No. of unit/s
UNECOBRITE10WLED827S24	9405	2517.00	20 N
UNECOBRITE10WLED830S24	9405	2517.00	20 N
UNECOBRITE10WLED840S24	9405	2517.00	20 N
UNECOBRITE15WLED827S24	9405	2836.00	20 N
UNECOBRITE15WLED830S24	9405	2836.00	20 N
UNECOBRITE15WLED840S24	9405	2836.00	20 N
UNECOBRITEATTACHEMENT RDRWHT	9405	539.00	20 N
UNECOBRITEATTACHEMENT OVALRWHT	9405	649.00	20 N
TDLRDFIXATTACHPLBLK	9405	1285.00	20 N
TDLRDFIXATTACHPLWHT	9405	1285.00	20 N
WWRDASYMFXATTACHPLWHT	9405	450.00	20 N

Ceiling cutout: Ø 75 mm, height 55 mm for 10 W. Ceiling cutout: Ø 75 mm, height 65 mm for 15 W

ORDERING : MODULE (MOD) + DRIVER (DRIVER TO BE ORDERED SEPARATELY)
Driver packed separately

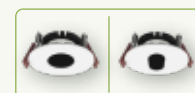

UNECO SURFACE SPOT LIGHT BLACK

Uneco surface light with black powder coated aluminum housing and pressure die-cast heat sink having high efficiency.

Item Description	HSN Code	MRP Rs. Per Unit (incl. of all taxes)	Case Lot No. of unit/s
UNECOSURFDLS8WLED830S24BLK	9405	3475.00	20 N
UNECOSURFDLS8WLED840S24BLK	9405	3475.00	20 N
UNECOSURFDLS8WLED857S24BLK	9405	3475.00	20 N
UNECOSURFDLS15WLED830S24BLK	9405	4172.00	20 N
UNECOSURFDLS15WLED840S24BLK	9405	4172.00	20 N
UNECOSURFDLS15WLED857S24BLK	9405	4172.00	20 N
UNECOSURFDLS20WLED830S36BLK	9405	5562.00	10 N
UNECOSURFDLS20WLED840S36BLK	9405	5562.00	10 N
UNECOSURFDLS20WLED857S36BLK	9405	5562.00	10 N
UNECOSURFDLS30WLED830S36BLK	9405	7622.00	10 N
UNECOSURFDLS30WLED840S36BLK	9405	7622.00	10 N
UNECOSURFDLS30WLED857S36BLK	9405	7622.00	10 N

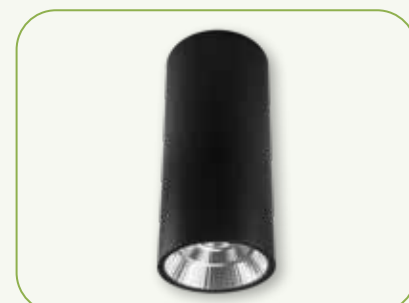

Indoor Commercial LED Luminaires

DOWNLIGHTS

UNECO SURFACE SPOT LIGHT WHITE

Uneco surface light with white powder coated aluminum housing and pressure die-cast heat sink having high efficiency.

Item Description	HSN Code	MRP Rs. Per Unit (incl. of all taxes)	Case Lot No. of unit/s
UNECOSURFDLS8WLED830S24WHT	9405	3475.00	20 N
UNECOSURFDLS8WLED840S24WHT	9405	3475.00	20 N
UNECOSURFDLS8WLED857S24WHT	9405	3475.00	20 N
UNECOSURFDLS15WLED830S24WHT	9405	4172.00	20 N
UNECOSURFDLS15WLED840S24WHT	9405	4172.00	20 N
UNECOSURFDLS15WLED857S24WHT	9405	4172.00	20 N
UNECOSURFDLS20WLED830S36WHT	9405	5562.00	10 N
UNECOSURFDLS20WLED840S36WHT	9405	5562.00	10 N
UNECOSURFDLS20WLED857S36WHT	9405	5562.00	10 N
UNECOSURFDLS30WLED830S36WHT	9405	7622.00	10 N
UNECOSURFDLS30WLED840S36WHT	9405	7622.00	10 N
UNECOSURFDLS30WLED857S36WHT	9405	7622.00	10 N



UNECO SUSPENDED SPOT LIGHT WHITE

Uneco pendant light with white powder coated aluminum housing and pressure die-cast heat sink having high efficiency.

Item Description	HSN Code	MRP Rs. Per Unit (incl. of all taxes)	Case Lot No. of unit/s
UNECOPENDDLP8WLED830S24WHT	9405	3863.00	20 N
UNECOPENDDLP8WLED840S24WHT	9405	3863.00	20 N
UNECOPENDDLP8WLED857S24WHT	9405	3863.00	20 N
UNECOPENDDLP15WLED830S24WHT	9405	4635.00	20 N
UNECOPENDDLP15WLED840S24WHT	9405	4635.00	20 N
UNECOPENDDLP15WLED857S24WHT	9405	4635.00	20 N
UNECOPENDDLP20WLED830S36WHT	9405	5947.00	10 N
UNECOPENDDLP20WLED840S36WHT	9405	5947.00	10 N
UNECOPENDDLP20WLED857S36WHT	9405	5947.00	10 N
UNECOPENDDLP30WLED830S36WHT	9405	8034.00	10 N
UNECOPENDDLP30WLED840S36WHT	9405	8034.00	10 N
UNECOPENDDLP30WLED857S36WHT	9405	8034.00	10 N



UNECO SUSPENDED SPOT LIGHT BLACK

Uneco pendant light with black powder coated aluminum housing and pressure die-cast heat sink having high efficiency.

Item Description	HSN Code	MRP Rs. Per Unit (incl. of all taxes)	Case Lot No. of unit/s
UNECOPENDDLP8WLED830S24BLK	9405	3863.00	20 N
UNECOPENDDLP8WLED840S24BLK	9405	3863.00	20 N
UNECOPENDDLP8WLED857S24BLK	9405	3863.00	20 N
UNECOPENDDLP15WLED830S24BLK	9405	4635.00	20 N
UNECOPENDDLP15WLED840S24BLK	9405	4635.00	20 N
UNECOPENDDLP15WLED857S24BLK	9405	4635.00	20 N
UNECOPENDDLP20WLED830S36BLK	9405	5947.00	10 N
UNECOPENDDLP20WLED840S36BLK	9405	5947.00	10 N
UNECOPENDDLP20WLED857S36BLK	9405	5947.00	10 N
UNECOPENDDLP30WLED830S36BLK	9405	8034.00	10 N
UNECOPENDDLP30WLED840S36BLK	9405	8034.00	10 N
UNECOPENDDLP30WLED857S36BLK	9405	8034.00	10 N

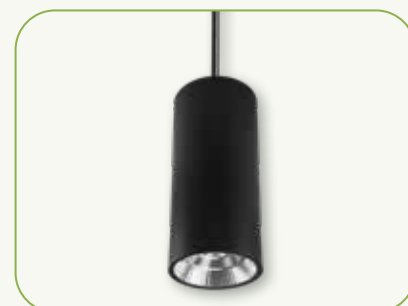

UNECO TRACK LIGHT

Track mounted LED light with modern design, compact size with High power COB LED to provide focussed light. Track light is a method of lighting where light fixtures are attached anywhere on a continuous track rail which is electrically charged as compared to the need of routing electrical wiring to individual light position.

Item Description	HSN Code	MRP Rs. Per Unit (incl. of all taxes)	Case Lot No. of unit/s
UNECOTRACKLIGHTTS10WLED830S15WHT	9405	2700.00	20 N
UNECOTRACKLIGHTTS10WLED840S15WHT	9405	2700.00	20 N
UNECOTRACKLIGHTTS10WLED857S15WHT	9405	2700.00	20 N
UNECOTRACKLIGHTTS15WLED830S38WHT	9405	3500.00	20 N
UNECOTRACKLIGHTTS15WLED840S38WHT	9405	3500.00	20 N
UNECOTRACKLIGHTTS15WLED857S38WHT	9405	3500.00	20 N
UNECOTRACKLIGHTTS25WLED830S60WHT	9405	4300.00	10 N
UNECOTRACKLIGHTTS25WLED840S60WHT	9405	4300.00	10 N
UNECOTRACKLIGHTTS25WLED857S60WHT	9405	4300.00	10 N
UNECOTRACKLIGHTTS30WLED830S60WHT	9405	5000.00	10 N
UNECOTRACKLIGHTTS30WLED840S60WHT	9405	5000.00	10 N
UNECOTRACKLIGHTTS30WLED857S60WHT	9405	5000.00	10 N
UNECOTRACKLIGHTTS10WLED830S15BLK	9405	2700.00	20 N
UNECOTRACKLIGHTTS10WLED840S15BLK	9405	2700.00	20 N
UNECOTRACKLIGHTTS10WLED857S15BLK	9405	2700.00	20 N
UNECOTRACKLIGHTTS15WLED830S38BLK	9405	3500.00	20 N
UNECOTRACKLIGHTTS15WLED840S38BLK	9405	3500.00	20 N
UNECOTRACKLIGHTTS15WLED857S38BLK	9405	3500.00	20 N
UNECOTRACKLIGHTTS25WLED830S60BLK	9405	4300.00	10 N
UNECOTRACKLIGHTTS25WLED840S60BLK	9405	4300.00	10 N
UNECOTRACKLIGHTTS25WLED857S60BLK	9405	4300.00	10 N
UNECOTRACKLIGHTTS30WLED830S60BLK	9405	5000.00	10 N
UNECOTRACKLIGHTTS30WLED840S60BLK	9405	5000.00	10 N
UNECOTRACKLIGHTTS30WLED857S60BLK	9405	5000.00	10 N



SCUBA TRACK LIGHT

Track based spot light with high efficiency reflector makes it ideal for lighting-up retail spaces with bright and crisp light throw. Suitable for 3 circuit-4 wire universal tracks.

Item Description	HSN Code	MRP Rs. Per Unit (incl. of all taxes)	Case Lot No. of unit/s
SCUBA35W930S55DBLK	9405	11000.00	4 N
SCUBA35W940S55DBLK	9405	11000.00	4 N
SCUBA35W865S55DBLK	9405	11000.00	4 N
SCUBA35W930S55DWHT	9405	11000.00	4 N
SCUBA35W940S55DWHT	9405	11000.00	4 N
SCUBA35W865S55DWHT	9405	11000.00	4 N



Indoor Commercial LED Luminaires

DOWNLIGHTS

UNECO TRACK LIGHT ACCESSORIES

Item Description	HSN Code	MRP Rs. Per Unit (incl. of all taxes)	Case Lot No. of unit/s
1MTR1PHASERACKTSWHT	9405	2300.00	6 N
1MTR1PHASERACKTSBLK	9405	2300.00	6 N
2MTR1PHASERACKTSWHT	9405	4250.00	6 N
2MTR1PHASERACKTSBLK	9405	4250.00	6 N
Flat ISHAPECONNECTOR1PHASETSWHT	9405	765.00	100 N
Flat LSHAPECONNECTOR1PHASETSWHT	9405	975.00	50 N
Flat TSHAPECONNECTOR1PHASETSWHT	9405	1000.00	50 N
Flat XSHAPECONNECTOR1 PHASETSWHT	9405	1200.00	50 N
Flat ISHAPECONNECTOR1PHASETSBLK	9405	765.00	100 N
Flat LSHAPECONNECTOR1PHASETSBLK	9405	975.00	50 N
Flat TSHAPECONNECTOR1PHASETSBLK	9405	1000.00	50 N
Flat XSHAPECONNECTOR1 PHASETSBLK	9405	1200.00	50 N



SCUBA TRACK LIGHT ACCESSORIES

Item Description	HSN Code	MRP Rs. Per Unit (incl. of all taxes)	Case Lot No. of unit/s
1MTR3PHASERACKTSBLK	9405	2700.00	8 N
2MTR3PHASERACKTSBLK	9405	4500.00	8 N
1MTR3PHASERACKTSWHT	9405	2700.00	8 N
2MTR3PHASERACKTSWHT	9405	4500.00	8 N



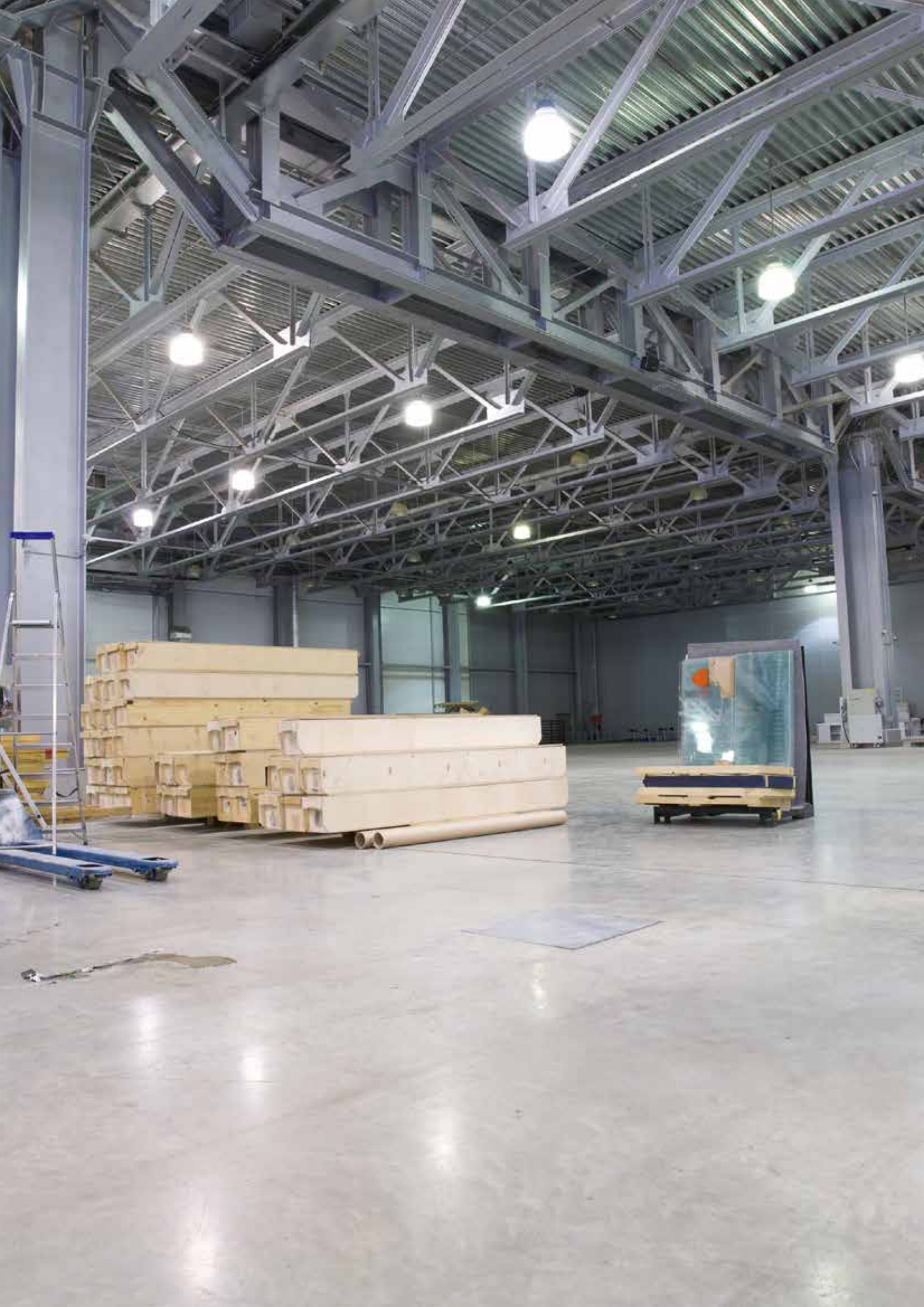

Industrial LED Luminaires

Havells offers a wide variety of solutions for all industrial applications. Havells ensures the enhancement of productivity of the employees with the right light to keep them motivated. The use of Havells Industrial lights provides fatigue-free and accident-free environment.

SAUCER NEXTGEN HIGHBAY

Next generation, energy saving, environment friendly & robust highbay LED with PDC housing suitable for ceiling (Surface/Suspended) mounting with system efficacy upto 150 lm/W.

Item Description	HSN Code	MRP Rs. Per Unit (incl. of all taxes)	Case Lot No. of unit/s
SAUCERGENXHBP80WLED757P60DBOLTG	9405	12500.00	1 N
SAUCERGENXHBP80WLED757P90DBOLTG	9405	12500.00	1 N
SAUCERGENXHBP100WLED757P90DBOLTG	9405	14000.00	1 N
SAUCERGENXHBP120WLED757P90DBOLTG	9405	15000.00	1 N
SAUCERGENXMIDHBP80WLED857PWBBOLTG	9405	14000.00	1 N
SAUCERGENXMIDHBP120WLED857PWBBOLTG	9405	19500.00	1 N
SAUCERGENXPROHBP80WLED757P90DBOLTG	9405	15000.00	1 N
SAUCERGENXPROHBP100WLED757P90DBOLTG	9405	18000.00	1 N
SAUCERGENXPROHBP100WLED757P60DBOLTG	9405	18000.00	1 N
SAUCERGENXPROHBP120WLED757P60DBOLTG	9405	19500.00	1 N
SAUCERGENXPROHBP120WLED757P90DBOLTG	9405	19500.00	1 N

Note: Dimmable, Occupancy Sensor, Lux sensor, Warm white, LILO - variants available upon request.



SAUCER NEXTGEN HIGHBAY - ADV SERIES

Next generation, energy saving, environment friendly & robust highbay LED with PDC housing suitable for ceiling (Surface/Suspended) mounting with system efficacy upto 150 lm/W.

Item Description	HSN Code	MRP Rs. Per Unit (incl. of all taxes)	Case Lot No. of unit/s
SAUCERGENXADVHBP150WLED857PWBBORL	9405	19000.00	1 N
SAUCERGENXADVHBP150WLED857PNBBORL	9405	19000.00	1 N
SAUCERGENXADVMIDHBP150WLED857PWBBORL	9405	22000.00	1 N
SAUCERGENXADVMIDHBP150WLED857PNBBORL	9405	22000.00	1 N
SAUCERGENXADVPROHBP150WLED857PWBBORL	9405	24000.00	1 N
SAUCERGENXADVPROHBP150WLED857PNBBORL	9405	24000.00	1 N
SAUCERGENXADVHBP180WLED757PWBBORL	9405	24250.00	1 N
SAUCERGENXADVHBP180WLED757PNBBORL	9405	24250.00	1 N
SAUCERGENXADVMIDHBP180WLED757PWBBORL	9405	26750.00	1 N
SAUCERGENXADVMIDHBP180WLED757PNBBORL	9405	26750.00	1 N
SAUCERGENXADVPROHBP180WLED757PWBBORL	9405	29750.00	1 N
SAUCERGENXADVPROHBP180WLED757PNBBORL	9405	30250.00	1 N
SAUCERGENXADVHBP200WLED757PWBBORL	9405	25000.00	1 N
SAUCERGENXADVHBP200WLED757PNBBORL	9405	25500.00	1 N
SAUCERGENXADVMIDHBP200WLED757PWBBORL	9405	27000.00	1 N
SAUCERGENXADVMIDHBP200WLED757PNBBORL	9405	27500.00	1 N
SAUCERGENXADVPROHBP200WLED757PWBBORL	9405	30000.00	1 N
SAUCERGENXADVPROHBP200WLED757PNBBORL	9405	30500.00	1 N

Note: Dimmable, Occupancy Sensor, Lux sensor, Warm white, LILO - variants available upon request.



ILIOSBAY PLUS HIGHBAY - IP65

IP65 energy saving, environment friendly & robust IP65 protected LED midbay with PDC housing suitable for ceiling (Surface/Suspended) mount & available in Wide beam optics. System efficacy 125 lm/W to 130 lm/W.

Item Description	HSN Code	MRP Rs. Per Unit (incl. of all taxes)	Case Lot No. of unit/s
ILIOSBAYPLUSHP50WLED857SP90DTPC	9405	11500.00	2 N
ILIOSBAYPLUSHP60WLED857SP90DTPC	9405	12000.00	2 N
ILIOSBAYPLUSHP70WLED857SP90DTPC	9405	12500.00	2 N
ILIOSBAYPLUSHP80WLED857SP90DTPC	9405	13000.00	2 N



Industrial LED Luminaires

HIGHBAY LIGHTING / WELL GLASS

BAYBRITE FLARE HIGHBAY

Baybrite Flare is a special designed, multi- functional LED luminaire to replace Industrial Low- bay.

Item Description	HSN Code	MRP Rs. Per Unit (incl. of all taxes)	Case Lot No. of unit/s
BAYBRITEFLAREHB120WLED757APWBBOLTG	9405	16500.00	2 N



PARABELLO HIGHBAY

Energy saving, environment friendly & robust Mediumbay /Highbay LED luminaire with high efficacy (100 lm/W) with toughened glass.

Item Description	HSN Code	MRP Rs. Per Unit (incl. of all taxes)	Case Lot No. of unit/s
PARABELLOHBP80WLED857PBOTG	9405	11000.00	4 N
PARABELLOHBP100WLED857PBOTG	9405	12000.00	4 N
PARABELLOHBP120WLED857PBOTG	9405	13500.00	4 N

Note: Lens variants available upon request.



GAZELLA HIGHBAY

Energy saving, environment friendly & robust Mediumbay /Highbay LED luminaire with high efficacy (100 lm/W) with toughened glass.

Item Description	HSN Code	MRP Rs. Per Unit (incl. of all taxes)	Case Lot No. of unit/s
GAZELLAHBP100WLED857PBOTG	9405	12570.00	1 N
GAZELLAHBP120WLED857PBOTG	9405	13920.00	1 N
GAZELLAHBP150WLED857PBOTG	9405	15270.00	1 N

Note: Lens variants available upon request.



STUPE WELL GLASS

Environmental friendly, energy saving long life corrosion resistant, vertical surface mounting pressure die-cast aluminium housing (light engine) well glass luminaires with high power LED as light source.

Item Description	HSN Code	MRP Rs. Per Unit (incl. of all taxes)	Case Lot No. of unit/s
STUPEWGP30WLED757SSYMTOPCGRY	9405	3500.00	6 N
STUPEWGP35WLED757SSYMTOPCGRY	9405	4000.00	6 N
STUPEWGP40WLED757SSYMTOPCGRY	9405	5000.00	6 N

Note: Warm white variant available upon request.



ENDURA WELL GLASS NEO - IP66

Environmental friendly, energy saving long life corrosion resistant, vertical surface mounting pressure die-cast aluminium housing (light engine) well glass luminaires with high power LED as light source.

Item Description	HSN Code	MRP Rs. Per Unit (incl. of all taxes)	Case Lot No. of unit/s
ENDURAWELLGLASSGENXP70WLED757PPC	9405	9600.00	6 N



ALTEZA WELL GLASS

Environmental friendly, energy saving long life corrosion resistant, pressure die-cast aluminium housing and control gear compartment well glass luminaires with LED as light source.

Item Description	HSN Code	MRP Rs. Per Unit (incl. of all taxes)	Case Lot No. of unit/s
ALTEZAWGS40WLED865SSYMTOPC	9405	4500.00	6 N

Note: 30 W/35 W available upon request.



HEXA 10 W - IP66

Environmental friendly, ultra modern, energy saving, surface mounted, decorative hexagon bulk head Back-lit LED luminaire comprising of high brightness LEDs.

Item Description	HSN Code	MRP Rs. Per Unit (incl. of all taxes)	Case Lot No. of unit/s
HEXAFT10WLED857SSYMBOPC	9405	2000.00	8 N

Note: Warm white variant available upon request.



RUGBY GENX 10

Designed with beautiful aesthetics using new generation technology in LED to enliven your outdoor and indoor areas in perfect synchronization with functionality and aesthetics. Family of bulkhead Lights designed to complement the geometry of the area with modern design.

Item Description	HSN Code	MRP Rs. Per Unit (incl. of all taxes)	Case Lot No. of unit/s
RUGBYGENXFTS10WLED865SSYMBOPC	9405	1650.00	12 N

Note: Warm white variant available upon request.



MAGNUM GRAND NEO

Energy saving, environmental friendly, long life, corrosion resistant, impact proof, surface mounting IP66 luminaire with PC housing & opal finish cover suitable for wet location. LEDs used as light source.

Item Description	HSN Code	MRP Rs. Per Unit (incl. of all taxes)	Case Lot No. of unit/s
MAGNUMGRANDNEOIP6620WLED857SPC	9405	5000.00	6 N
MAGNUMGRANDNEOIP6636WLED857SPC	9405	6000.00	6 N
MAGNUMGRANDNEOIP6640WLED857SPC	9405	6250.00	6 N

Note: Dimmable - variants available upon request.



MAGNUM GRAND PWB (with emergency back-up)

Energy saving, environmental friendly, long life, corrosion resistant, impact proof, Emergency Battery Back-up, surface mounting IP66 luminaire with PC housing & opal finish cover suitable for wet location.

Item Description	HSN Code	MRP Rs. Per Unit (incl. of all taxes)	Case Lot No. of unit/s
MAGNUMGRANDPWBIP6620WLED857SPC	9405	14000.00	6 N
MAGNUMGRANDPWBIP6636WLED857SPC	9405	14500.00	6 N
MAGNUMGRANDPWBIP6640WLED857SPC	9405	16000.00	6 N



Industrial LED Luminaires

WEATHER PROOF / CLEAN ROOM

MAGNUM RETRO (Single Side Connection)

Energy saving, environmental friendly, long life, corrosion resistant, impact proof, surface/suspended mounting luminaire with PC housing and linear ribbed PC cover for glare free light, suitable for T8 LED Tube with single side connection.

Item Description	HSN Code	MRP Rs. Per Unit (incl. of all taxes)	Case Lot No. of unit/s
MAGNUMRETROILS1X18PC	9405*	3000.00	6 N
MAGNUMRETROILS2X18PC	9405*	4000.00	6 N



MAGNUM GRAND GOLD

Energy saving, environmental friendly, long life, corrosion resistant, impact proof, surface mounting IP66 luminaire with PC housing & opal finish cover suitable for wet location.

Item Description	HSN Code	MRP Rs. Per Unit (incl. of all taxes)	Case Lot No. of unit/s
MAGNUMGRANDGOLD20WLED857SPC	9405	4000.00	12 N
MAGNUMGRANDGOLD36WLED857SPC	9405	4500.00	12 N
MAGNUMGRANDGOLD40WLED857SPC	9405	5000.00	12 N



LED CLEAN ROOM BOTTOM OPENING MS EXE

IP65, dust free & zero maintenance 1x1 / 2x2 LED Clean Room Bottom Opening luminaire for hygienic facilities.

Item Description	HSN Code	MRP Rs. Per Unit (incl. of all taxes)	Case Lot No. of unit/s
BOCR1X1R18WLED857SPCMSEXEXE	9405	6500.00	2 N
BOCR2X2R36WLED857SPCMSEXEXE	9405	10000.00	2 N
BOCR2X2R42WLED857SPCMSEXEXE	9405	10500.00	2 N
BOCR2X2R60WLED857SPCMSEXEXE	9405	13000.00	2 N
BOCR2X2R80WLED857SPCMSEXEXE	9405	13500.00	2 N

Note: SS, Screwless, 2x1, variants available upon request.



LED CLEAN ROOM TOP OPENING MS EXE

IP65, dust free & zero maintenance 1x1 / 2x2 LED Clean Room Top Opening luminaire for hygienic facilities.

Item Description	HSN Code	MRP Rs. Per Unit (incl. of all taxes)	Case Lot No. of unit/s
TOCR1X1R18WLED857SPCMSEXEXE	9405	7000.00	2 N
TOCR2X2R36WLED857SPCMSEXEXE	9405	11500.00	2 N
TOCR2X2R42WLED857SPCMSEXEXE	9405	12000.00	2 N
TOCR2X2R60WLED857SPCMSEXEXE	9405	14112.00	2 N
TOCR2X2R80WLED857SPCMSEXEXE	9405	14336.00	2 N

Note: SS, variants available upon request.





Outdoor LED Luminaires

Introducing the wide range of outdoor application LED products from Havells. This range is yet another example of Havells' endeavour to innovate and provide world class lighting solution, energy efficient products and robust design. These lights are designed to fulfill the lighting applications of City Road Lighting, Periphery Lighting, Prestigious Heritage Area Outdoor Lighting and Urban Landscape Lighting.

ENDURA SUNDOWN

New generation energy saving and environmental friendly long life LED street light made up of pressure die cast aluminium housing with high efficiency LED as lighting source and lens embedded PC cover having Bottom Opening separate driver compartment with IP66 protection and impact resistance of IK08.

Item Description	HSN Code	MRP Rs. Per Unit (incl. of all taxes)	Case Lot No. of unit/s
ENDURASUNDOWNSL25WLED765PASYBOPCIHD	9405	3200.00	8 N
ENDURASUNDOWNSL30WLED757PASYBOPC	9405	3584.00	8 N
ENDURASUNDOWNSL35WLED765PASYBOPC	9405	4500.00	8 N
ENDURASUNDOWNSL40WLED765PASYBOPC	9405	5040.00	8 N
ENDURASUNDOWNSL45WLED765PASYBOPC	9405	6000.00	8 N

Suitable for pole dia Ø 42 mm (max.)



ENDURA SUNDOWN TG

New generation energy saving and environmental friendly long life LED street light made up of pressure die cast aluminium housing with high efficiency LED as lighting source and lens with Toughened Glass having Bottom Opening separate driver compartment with IP66 protection and impact resistance of IK07.

Item Description	HSN Code	MRP Rs. Per Unit (incl. of all taxes)	Case Lot No. of unit/s
ENDURASUNDOWNSL25WLED765PASYBOTGIHD	9405	3800.00	8 N
ENDURASUNDOWNSL45WLED765PASYBOTG	9405	6800.00	8 N

Suitable for pole dia Ø 42 mm (max.)



ENDURA SUNDOWN TG

New generation energy saving and environmental friendly long life LED street light made up of pressure die cast aluminium housing with high efficiency LED as lighting source and Toughened glass having Bottom Opening separate driver compartment with IP66 protection and impact resistance of IK07.

Item Description	HSN Code	MRP Rs. Per Unit (incl. of all taxes)	Case Lot No. of unit/s
ENDURASUNDOWNSL60WLED765PASYBOTG	9405	7280.00	6 N
ENDURASUNDOWNSL70WLED765PASYBOTG	9405	8064.00	6 N
ENDURASUNDOWNSL72WLED765PASYBOTG	9405	8500.00	6 N
ENDURASUNDOWNSL90 WLED765PASYBOTG	9405	13000.00	6 N
ENDURASUNDOWNSL120 WLED765PASYBOTG	9405	16000.00	6 N

Suitable for pole dia Ø 54 mm (max.)



ENDURA CITYLITE PLATINUM PLUS

Energy saving and environmental friendly long life LED street light made up of pressure die cast aluminium housing with high power LED as lighting source and lens embedded PC cover having IP65 protection and Impact resistance of IK07 with 10 kV Built-in Surge Protection Device.

Item Description	HSN Code	MRP Rs. Per Unit (incl. of all taxes)	Case Lot No. of unit/s
ENDURACITYLITEPLAT+SL48WLED757PASYBOPC	9405	6500.00	8 N

Suitable for pole dia Ø 42 mm (max.)



Outdoor Luminaires

STREET LIGHTS

ENDURA OMNIPLUS

New generation energy saving and environmental friendly long life LED street light made up of pressure die cast aluminium housing with high efficiency LEDs as lighting source and lens embedded PC cover having TOP Opening separate driver compartment with IP66 protection and impact resistance of IK07.

Item Description	HSN Code	MRP Rs. Per Unit (incl. of all taxes)	Case Lot No. of unit/s
ENDURAOMNIPLUSL60WLED757SASYTOPC	9405	7400.00	6 N
ENDURAOMNIPLUSL70WLED757SASYTOPC	9405	7600.00	6 N
ENDURAOMNIPLUSL72WLED757SASYTOPC	9405	7650.00	6 N
ENDURAOMNIPLUSL90WLED757SASYTOPC	9405	10000.00	4 N
ENDURAOMNIPLUSL100WLED757SASYTOPC	9405	11000.00	4 N
ENDURAOMNIPLUSL110WLED757SASYTOPC	9405	12500.00	2 N
ENDURAOMNIPLUSL120WLED757SASYTOPC	9405	13000.00	2 N

Suitable for pole dia Ø 41 mm (max.) for 60 W, 70 W, 72 W.
Suitable for pole dia Ø 50 mm (max.) for 90 W, 100 W, 110 W.
Suitable for pole dia Ø 58.5 mm (max.) for 120 W.



ENDURA PEARL PLUS

New generation energy saving and environmental friendly long life LED street light made up of pressure die cast aluminium housing with high efficiency LEDs as lighting source and lens embedded PC cover having TOP Opening separate driver compartment with IP66 protection and impact resistance of IK08.

Item Description	HSN Code	MRP Rs. Per Unit (incl. of all taxes)	Case Lot No. of unit/s
ENDURAPEARLPLUSL100WLED757PASYTOPCLC	9405	12000.00	6 N
ENDURAPEARLPLUSL120WLED757PASYTOPCLC	9405	14000.00	6 N
ENDURAPEARLPLUSL135WLED757PASYTOPCLC	9405	16500.00	6 N
ENDURAPEARLPLUSL150WLED757PASYTOPCLC	9405	17000.00	6 N

Suitable for pole dia Ø 54 mm (max.)



ENDURA PEARL MAGNUM

New generation energy saving & environmental friendly long life Versatile pressure die-cast aluminium IP66 roadway luminaire with high power LED as light source.

Item Description	HSN Code	MRP Rs. Per Unit (incl. of all taxes)	Case Lot No. of unit/s
ENDURAPEARLMAGNUMSL150WLED757PASYTOTGHO	9405	18000.00	4 N

Suitable for pole dia Ø 58 mm (max.)



ENDURA PEARL MAGNUM PLUS

New generation energy saving & environmental friendly long life Versatile pressure die-cast aluminium IP66 roadway luminaire with high power LED as light source.

Item Description	HSN Code	MRP Rs. Per Unit (incl. of all taxes)	Case Lot No. of unit/s
ENDURAPEARLMAGPLUSL170WLED757PASYTOTG	9405	22000.00	2 N
ENPEARLMAGPLUSL180WLED757PASYTOTGHEENT	9405	22500.00	2 N
ENPEARLMAGPLUSL190WLED757PASYTOTGHEENT	9405	25000.00	2 N
ENPEARLMAGPLUSL210WLED757PASYTOTGHEENT	9405	27000.00	2 N
Endura Pearl Magnum Plus 200W HEE WTX	9405	28000.00	2 N

Suitable for pole dia Ø 60 mm (max.)



Outdoor LED Luminaires

STREET LIGHTS

ENDURA PEARL GRAND PLUS

New generation energy saving & environmental friendly long life Versatile pressure die-cast aluminium IP66 roadway luminaire with high power LED as light source.

Item Description	HSN Code	MRP Rs. Per Unit (incl. of all taxes)	Case Lot No. of unit/s
ENDURAPEARLGRANDPLUSL250WLED757PASYSOTG Suitable for pole dia Ø 60 mm (max.)	9405	38000.00	2 N



Outdoor Luminaires

CANOPY FIXTURE / PIT LIGHTS

FLARE ULTIMA

Flare Ultima is specially designed, multi-functional LED luminaire to replace under canopy.

Item Description	HSN Code	MRP Rs. Per Unit (incl. of all taxes)	Case Lot No. of unit/s
FLAREULTIMACA80WLED757PWBLTG	9405	11000.00	1 N
FLAREULTIMACA100WLED757PWBLTG	9405	12650.00	1 N
LSPAREASSEMPOWCOATFRAME375X375X1 FU	9405	1400.00	1 N
ASSEMBLEDPOWCOATFRAME600X600X1 FU	9405	2000.00	1 N



GLINT

Linear Canopy is a special, multi-functional LED luminaire designed to replace traditional square under canopy lights in fuel bunks.

Item Description	HSN Code	MRP Rs. Per Unit (incl. of all taxes)	Case Lot No. of unit/s
GLINTCAR80WLED857PIWBTOLTG	9405	33000.00	1 N
GLINTCARWS80WLED857PIWBTOLPC	9405	31000.00	1 N

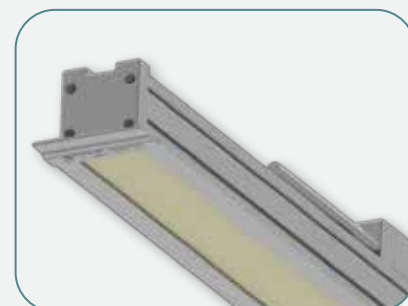

JETA TRENCH

Pit Lights are industrial luminaires specifically designed for service pits. Havells pit light is a fusion of engineering and modern design to provide beautiful aesthetics, durability and high lumen output.

Item Description	HSN Code	MRP Rs. Per Unit (incl. of all taxes)	Case Lot No. of unit/s
JETATRENCHFTS20WLED757PBOPC48V	9405	6600.00	1 N
JETATRENCHFTS20WLED757PBOPC	9405	7000.00	1 N



JETA QUANTO PLUS

Energy saving, environmental friendly, long life, one design for aesthetic consistency in multi purpose application with SMD LEDs as light source with driver included, suitable for highlighting architectural features or Area lighting. Also suitable to rough services/installations.

Item Description	HSN Code	MRP Rs. Per Unit (incl. of all taxes)	Case Lot No. of unit/s
JETAQUANTOPLUSFLP30WLED757SYMLENS	9405	5300.00	6 N
JETAQUANTOPLUSFLP50WLED757SYMLENS	9405	6350.00	6 N
JETAQUANTOPLUSFLP60WLED757SYMLENS	9405	7150.00	6 N



JETA ALBA

Energy saving, environmental friendly, long life, exclusive innovative die-cast aluminium IP66 flood light, suitable for highlighting architectural facade and general purpose lighting.

Item Description	HSN Code	MRP Rs. Per Unit (incl. of all taxes)	Case Lot No. of unit/s
JETAALBAFLOODLIGHT60W	9405	8800.00	4 N
JETAALBAFLOODLIGHT70W	9405	9900.00	4 N
JETAALBAFLOODLIGHT80W	9405	10300.00	4 N
JETAALBAFLOODLIGHT100W	9405	13600.00	4 N



JETA IRIS

Energy saving, environmental friendly, long life, exclusive innovative die-cast aluminium IP66 flood light, suitable for highlighting architectural facade and general purpose lighting.

Item Description	HSN Code	MRP Rs. Per Unit (incl. of all taxes)	Case Lot No. of unit/s
JETAIRISFL100WLED757ARWBLTG	9405	14300.00	1 N
JETAIRISFL120WLED757APWBLTG	9405	14400.00	1 N
JETAIRISFLS150WLED757P2AV2WBLTG	9405	17500.00	1 N
JETAIRISFLS160WLED757P2AWBLTG	9405	19000.00	1 N



JETA IRIS ALPHA

Energy saving, environmental friendly, long life, exclusive innovative die-cast aluminium IP66 flood light, suitable for highlighting architectural facade and general purpose lighting.

Item Description	HSN Code	MRP Rs. Per Unit (incl. of all taxes)	Case Lot No. of unit/s
JETAIRISALPHAFL200WLED857PBOLTG	9405	18200.00	1 N
JETAIRISALPHAFL250WLED757APLTG	9405	22000.00	1 N
JETAIRISALPHAFL300WLED757PLTG	9405	29000.00	1 N



JETA IRIS MAX

Energy saving, environmental friendly, long life, exclusive innovative die-cast aluminium IP66 flood light, suitable for highlighting architectural facade and general purpose lighting.

Item Description	HSN Code	MRP Rs. Per Unit (incl. of all taxes)	Case Lot No. of unit/s
JETAIRISMAXFL180WLED757PWBLTG	9405	25300.00	1 N
JETAIRISMAXFL200WLED757PWBLTG	9405	25700.00	1 N
JETAIRISMAXFL250WLED757PWBLTG	9405	29900.00	1 N
JETAIRISMAXFL300WLED757PNBLTG	9405	43700.00	1 N
JETAIRISMAXFL300WLED757PWBLTG	9405	43700.00	1 N



Outdoor LED Luminaires

FLOOD LIGHTS

JETA VALOUR FL INT P 180 W/ 200 W/ 300 W / 350 W / 400 W / 500 W

Energy saving, environment friendly, long life, exclusive innovative die-cast aluminium flood light with highly efficient LEDs as light source, suitable for highlighting architectural features.

Item Description	HSN Code	MRP Rs. Per Unit (incl. of all taxes)	Case Lot No. of unit/s
JETAVALOURFL180WLED757PINTNBLTG	9405	29700.00	1 N
JETAVALOURFL180WLED757PINTWBLTG	9405	29700.00	1 N
JETAVALOURFL200WLED757PINTNBLTG	9405	31200.00	1 N
JETAVALOURFL200WLED757PINTWBLTG	9405	31200.00	1 N
JETAVALOURLEFL300W2MLED757PINTNMBLTG	9405	42900.00	1 N
JETAVALOURLEFL300W2MLED757PINTMBLTG	9405	42900.00	1 N
JETAVALOURLEFL350W2MLED757PINTMBLTG	9405	49000.00	1 N
JETAVALOURLEFL350W2MLED757PINTNMBLTG	9405	49000.00	1 N
JETAVALOURLEFL400W3MLED757PINTNMBLTG	9405	58700.00	1 N
JETAVALOURLEFL400W3MLED757PINTMBLTG	9405	58700.00	1 N
JETAVALOURLEFL500W4MLED757PINTMBLTG	9405	67900.00	1 N
JETAVALOURLEFL500W4MLED757PINTNMBLTG	9405	67900.00	1 N



JETA VALOUR NON INTEGRAL

Energy saving, environment friendly, long life, exclusive innovative die-cast aluminium flood light with highly efficient LEDs as light source, suitable for highlighting architectural features.

Item Description	HSN Code	MRP Rs. Per Unit (incl. of all taxes)	Case Lot No. of unit/s
JETAVALOURFL180WLED757MODNBLTG	9405	20900.00	1 N
ASSEMBLEDCGBOXVALOUR180WAP	9405	16500.00	1 N
JETAVALOURFL180WLED757MODWBLTG	9405	21600.00	1 N
ASSEMBLEDCGBOXVALOUR180WAP	9405	16500.00	1 N
JETAVALOURFL200WLED757MODNBLTG	9405	23100.00	1 N
ASSEMBLEDCGBOXVALOUR200WAP	9405	18000.00	1 N
JETAVALOURFL200WLED757MODWBLTG	9405	23100.00	1 N
ASSEMBLEDCGBOXVALOUR200WAP	9405	18000.00	1 N
JETAVALOURFL240WLED757MODWBLTG	9405	24600.00	1 N
ASSEMBLEDCGBOXVALOUR240WAP	9405	22000.00	1 N
JETAVALOURFL240WLED757MODNBLTG	9405	24600.00	1 N
ASSEMBLEDCGBOXVALOUR240WAP	9405	22000.00	1 N
JETAVALOURFL300WLED757MODNBLTG	9405	25000.00	1 N
ASSEMBLEDCGBOXVALOUR300WAP	9405	23100.00	1 N
JETAVALOURFL300WLED757MODWBLTG	9405	25000.00	1 N
ASSEMBLEDCGBOXVALOUR300WAP	9405	23100.00	1 N
JETAVALOURFL350W3MLED757MODNBLTG	9405	30600.00	1 N
ASSEMBLEDCGBOXVALOUR350W3MAP	9405	23400.00	1 N
JETAVALOURFL400WLED757MODNBLTG	9405	33000.00	1 N
ASSEMBLEDCGBOXVALOUR400WAP	9405	25500.00	1 N
JETAVALOURFL400WLED757MODWBLTG	9405	33000.00	1 N
ASSEMBLEDCGBOXVALOUR400WAP	9405	25500.00	1 N
JETAVALOURFL500WLED757MODNBLTG	9405	50600.00	1 N
ASSEMBLEDCGBOXVALOUR500WP	9405	32200.00	1 N
JETAVALOURFL500WLED757MODWBLTG	9405	50600.00	1 N
ASSEMBLEDCGBOXVALOUR500WP	9405	32200.00	1 N
L.SPARE 5C-CABLE 25M WITH IPCONNECTOR	9405	12000.00	1 N
L.SPARE 5 C-CABLE 15M WITH IPCONNECTOR	9405	8600.00	1 N



JETA FLAUNT 800 W

Energy saving, environment friendly, long life, exclusive innovative die-cast aluminium flood light with highly efficient LEDs as light source, suitable for highlighting architectural features and sports complex.

Item Description	HSN Code	MRP Rs. Per Unit (incl. of all taxes)	Case Lot No. of unit/s
JETAFLAUNTFL800W6MLED757MODNMBILTG	9405	55000.00	1 N
ASSEMBLEDCGBOXFLAUNT540WIP	9405	18900.00	1 N
ASSEMBLEDCGBOXFLAUNT260WIP	9405	12200.00	1 N



JETA FLAUNT 1000 W

Energy saving, environment friendly, long life, exclusive innovative die-cast aluminium flood light with highly efficient LEDs as light source, suitable for highlighting architectural features and sports complex.

Item Description	HSN Code	MRP Rs. Per Unit (incl. of all taxes)	Case Lot No. of unit/s
JETAFLAUNTFL1000W8MLED757MODNMBILTG	9405	124000.00	1 N
JETAVALOURFL500WLED757MODWBLTG	9405	32200.00	1 N

(Two CG Box to be used with each fixture)



JETA QUANTO

Energy saving, environmental friendly, long life, one design for aesthetic consistency in multi purpose application with SMD LEDs as light source with driver included, suitable for highlighting architectural features or Area lighting. Also suitable to rough services/installations.

Item Description	HSN Code	MRP Rs. Per Unit (incl. of all taxes)	Case Lot No. of unit/s
JETAQUANTOFLS30WLED765SYMPCGRY	9405	2200.00	10 N
JETAQUANTOFLS50WLED765SYMPC	9405	4000.00	10 N



JETA ADORN

New generation energy saving & environmental friendly, long life, pressure die - cast aluminium housing Flood Light with PC diffused lens enclosure over LED for glare free light.

Item Description	HSN Code	MRP Rs. Per Unit (incl. of all taxes)	Case Lot No. of unit/s
JETAADORNFLS30WLED757SSYMTOTG	9405	2200.00	4 N
JETAADORNFLS50WLED757SSYMTOTG	9405	4000.00	2 N
JETAADORNFLS70WLED757SSYMTOTG	9405	4700.00	2 N
JETAADORNFLS80WLED757SSYMTOTG	9405	5100.00	2 N
JETAADORNFLS100WLED757SSYMTOTG	9405	7000.00	2 N
JETAADORNFLS120WLED757SSYMTOTG	9405	7200.00	2 N
JETAADORNFLS150WLED757SSYMTOTG	9405	9000.00	2 N
JETAADORNFLS200WLED757PR1SYMTOTG	9405	13300.00	1 N



Outdoor LED Luminaires

LANDSCAPE LIGHTS

TYCOON LED POST TOP

Design inspired from the classical Victorian era using new generation technology in LED to rejuvenate your outdoor areas with functionality during night and aesthetics during the day. IP65 die cast Aluminium Post top lantern designed with long life LED engine & Electronic Driver, designed for glare free symmetrical light distribution.

Item Description	HSN Code	MRP Rs. Per Unit (incl. of all taxes)	Case Lot No. of unit/s
TYCOONPT70WLED757PSYMTOPC	9405	47500.00	1 N
TYCOONPT70WLED730PSYMTOPC	9405	47500.00	1 N

Suitable for pole dia Ø 76 mm



BARON LED POST TOP

Design inspired from the classical Victorian era using new generation technology in LED to rejuvenate your outdoor areas with functionality during night and aesthetics during the day. IP65 die cast Aluminium Post top lantern designed with long life LED engine & Electronic Driver, designed for glare free symmetrical light distribution.

Item Description	HSN Code	MRP Rs. Per Unit (incl. of all taxes)	Case Lot No. of unit/s
BARONPT70WLED757PSYMTOPC	9405	43500.00	1 N
BARONPT70WLED730PSYMTOPC	9405	43500.00	1 N

Suitable for pole dia Ø 76 mm

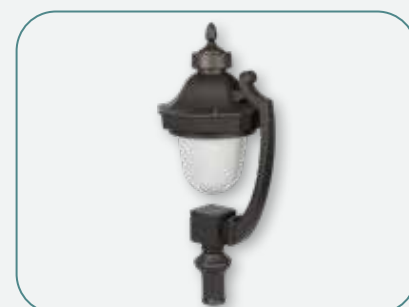

VICTORIA LED POST TOP

Design from the renaissance era yet with a modern look using new generation technology in LED to enliven your outdoor areas in perfect synchronization with functionality and aesthetics. IP66 Family of post top lantern designed to complement the geometry of the area.

Item Description	HSN Code	MRP Rs. Per Unit (incl. of all taxes)	Case Lot No. of unit/s
VICTORIAPT35WLED757PSYMTOTG	9405	34000.00	1 N
VICTORIAPT35WLED730PSYMTOTG	9405	34000.00	1 N
VICTORIAPT50WLED730PSYMTOTG	9405	41000.00	1 N
VICTORIAPT50WLED757PSYMTOTG	9405	41000.00	1 N

Suitable for pole dia Ø 76 mm



SPRING 6 LED POST TOP

New generation IP 65 LED post-top, energy saving, environmental friendly, long life aesthetically designed with good indirect symmetrical light distribution, die-cast aluminium landscape luminaire with high power COB LED as light source.

Item Description	HSN Code	MRP Rs. Per Unit (incl. of all taxes)	Case Lot No. of unit/s
ENDURASPRING6PT35WLED757PSYMTOTG	9405	28500.00	2 N
ENDURASPRING6PT35WLED740PSYMTOTG	9405	28500.00	2 N

Suitable for pole dia Ø 76 mm



RINK LED POST TOP

Circular LED post-top offering excellent uniform illumination and aesthetics in one go. Made up of Pressure Die Cast aluminium body and opal PC cover. IP 66 and IK 07 rating ensures it stands tall amid varied environmental conditions.

Item Description	HSN Code	MRP Rs. Per Unit (incl. of all taxes)	Case Lot No. of unit/s
RINKPT45WLED757PSYMTOPC	9405	22000.00	1 N
RINKPT60WLED757PSYMTOPC	9405	25000.00	1 N

Suitable for pole dia Ø 76 mm. Option of 3000K CCT is available against MOQ



JUPITER LED POST TOP

Aesthetically designed IP 65 LED post top with aluminium enclosure, powered with high power LEDs as light source and die casted heat sink exhibits classic Victorian look with symmetrical light distribution and excellent heat dissipation for long life.

Item Description	HSN Code	MRP Rs. Per Unit (incl. of all taxes)	Case Lot No. of unit/s
JUPITERMAXIPT50WLED830PSYMTOPC	9405	15750.00	1 N
JUPITERMAXIPT50WLED757PSYMTOPC	9405	15750.00	1 N
JUPITERMAXIPT70WLED830PSYMTOPC	9405	17850.00	1 N
JUPITERMAXIPT70WLED757PSYMTOPC	9405	17850.00	1 N

Suitable for pole dia Ø 76 mm



RUBY LED POST TOP

New generation, IP 65 LED post-top family, energy saving, environmental friendly, long life aesthetically designed with symmetrical light distribution, spun aluminium landscape luminaire with high power LEDs as light source. Clear Cover offers bright illumination for different applications.

Item Description	HSN Code	MRP Rs. Per Unit (incl. of all taxes)	Case Lot No. of unit/s
RUBYMINIPT15WLED830PSYMTOPC	9405	6500.00	1 N
RUBYMINIPT15WLED757PSYMTOPC	9405	6500.00	1 N
RUBYPT25WLED830SSYMTOPC	9405	9100.00	1 N
RUBYPT25WLED757SSYMTOPC	9405	9100.00	1 N
RUBYPT35WLED830PSYMTOPC	9405	10900.00	1 N
RUBYPT35WLED757PSYMTOPC	9405	10900.00	1 N
RUBYPT40WLED757PSYMTOPC	9405	11500.00	1 N
RUBYPT40WLED830PSYMTOPC	9405	11500.00	1 N
RUBYPT40WLED757PSYMTOPC	9405	11500.00	1 N
RUBYPT45WLED757PSYMTOPC	9405	13000.00	1 N
RUBYMAXIPT50WLED830PSYMTOPC	9405	13500.00	1 N
RUBYMAXIPT50WLED757PSYMTOPC	9405	13500.00	1 N
RUBYMAXIPT70WLED830PSYMTOPC	9405	16500.00	1 N
RUBYMAXIPT70WLED757PSYMTOPC	9405	16500.00	1 N

Suitable for pole dia Ø 50 mm for 15 W
Suitable for pole dia Ø 76 mm for 25 W/35 W/40 W/45 W/50 W/70 W



CORAL LED POST TOP

New generation, IP 65 LED post-top family, energy saving, environmental friendly, long life aesthetically designed with symmetrical light distribution, spun aluminium landscape luminaire with high power LEDs as light source. Opal Cover offers soothing uniform illumination for different applications.

Item Description	HSN Code	MRP Rs. Per Unit (incl. of all taxes)	Case Lot No. of unit/s
CORALMINIPT15WLED830PSYMTOPC	9405	6500.00	1 N
CORALMINIPT15WLED757PSYMTOPC	9405	6500.00	1 N
CORALPT25WLED830SSYMTOPC	9405	9100.00	1 N
CORALPT25WLED757PSYMTOPC	9405	9100.00	1 N
CORALPT35WLED830PSYMTOPC	9405	10900.00	1 N
CORALPT35WLED757PSYMTOPC	9405	10900.00	1 N
CORALPT45WLED757PSYMTOPC	9405	13000.00	1 N
CORALMAXIPT50WLED830PSYMTOPC	9405	13500.00	1 N
CORALMAXIPT50WLED757PSYMTOPC	9405	13500.00	1 N
CORALMAXIPT70WLED830PSYMTOPC	9405	16500.00	1 N
CORALMAXIPT70WLED757PSYMTOPC	9405	16500.00	1 N

Suitable for pole dia Ø 50 mm for 15 W, Suitable for pole dia Ø 76 mm for 25 W/35 W/45 W/50 W/70 W



Outdoor Luminaires

LANDSCAPE LIGHTS

NEBULA LED POST TOP

Stellar LED post-top offering combination of sturdy design, excellent illumination and aesthetics in one go. IP 66 and IK 10 rating ensures it stands tall amid varied environmental conditions.

Item Description	HSN Code	MRP Rs. Per Unit (incl. of all taxes)	Case Lot No. of unit/s
NEBULAPT40WLED857PSYMTOPC	9405	13000.00	1 N
NEBULAPT40WLED857PSYMTOPCO	9405	13000.00	1 N
NEBULAPT60WLED857PSYMTOPC	9405	16000.00	1 N
NEBULAPT60WLED857PSYMTOPCO	9405	16000.00	1 N

Suitable for pole dia Ø 76 mm. Option of 3000K CCT is available against MOQ



IRVINE – SPIKE LIGHT

Environmental friendly, compact, light weight, energy saving, IP66 LED spike light using COB LED as light source. Offered in Mono – Red, Green, Blue and Warm White Colour. Multi purpose application like column lighting, tree up-lighting, statue accentuation etc. can be addressed with ease.

Item Description	HSN Code	MRP Rs. Per Unit (incl. of all taxes)	Case Lot No. of unit/s
IRVINESPS5WLED830PSYMTG	9405	3200.00	4 N
IRVINESPS5WLEDREDPSYMTG	9405	3800.00	4 N
IRVINESPS5WLEDGRNPSYMTG	9405	3800.00	4 N
IRVINESPS5WLEDBLUPSYMTG	9405	3800.00	4 N

For mounting info refer TDS. Spike is part of std. packaging

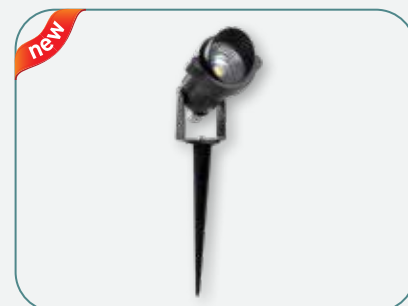

CLIO LED WALL LIGHT

Environmental friendly, new generation, energy saving, decorative IP 66 LED UP-down Luminaire with wall surface mounting using COB LED as light source.

Item Description	HSN Code	MRP Rs. Per Unit (incl. of all taxes)	Case Lot No. of unit/s
CLIOILL15WLED730PSYMTOTUG	9405	8200.00	4 N
CLIOWLS15WLED830PSYMTOTG	9405	8500.00	4 N
CLIOWLS25WLED830PSYMTOTG	9405	10500.00	4 N

For mounting info refer TDS



LYCUS LED SPIKE LIGHT

Environmental friendly, new generation, energy saving, decorative IP66 LED spike light using COB LED as light source.

Item Description	HSN Code	MRP Rs. Per Unit (incl. of all taxes)	Case Lot No. of unit/s
LYCUSSPS9WLED730PSYMBOTG	9405	6500.00	4 N
LYCUSSPS15WLED730PSYMBOTG	9405	7750.00	4 N
LYCUSSPS25WLED730PSYMBOTG	9405	9250.00	4 N

For mounting info refer TDS



RADIANT LED STEP LIGHT

Environmental friendly, new generation, energy saving, decorative rectangular shaped IP66 LED step light for wall recessed application.

Item Description	HSN Code	MRP Rs. Per Unit (incl. of all taxes)	Case Lot No. of unit/s
RADIANTFTR07WLED830PSYMTOPC	9405	3600.00	16 N

For mounting info refer TDS



DECO POLE

Aesthetically designed decorative hot dipped galvanised mild steel step pole with grey powder finish. Compatible for all Havells post top range. Window - Plasma cut & duly chamfered opening window of 300x110 mm for terminal connections & mounting accessories. Window cover is fitted with allen screws to the pole.

Item Description	HSN Code	MRP Rs. Per Unit (incl. of all taxes)	Case Lot No. of unit/s
DECO POLE 3M TOP Ø 76 MM	7308	27000.00	1 N
DECO POLE 3.5M TOP Ø 76 MM	7308	30500.00	1 N
DECO POLE 4M TOP Ø 76 MM	7308	34000.00	1 N
DECO POLE 6M TOP Ø 76 MM	7308	49000.00	1 N

For mounting info refer TDS. Also available in ABC (Anti-Bacterial & Beach Coating) against MOQ.



ECO POLE

Aesthetically designed decorative hot dipped galvanised mild steel step pole with grey powder finish. Compatible for all Havells post top range. Window - Plasma cut & duly chamfered opening window of 300x110 mm for terminal connections & mounting accessories. Window cover is fitted with allen screws to the pole. Decorative sleek casting ring to increase aesthetical appeal.

Item Description	HSN Code	MRP Rs. Per Unit (incl. of all taxes)	Case Lot No. of unit/s
ECO POLE 3M TOP Ø 76 MM	7308	24000.00	1 N
ECO POLE 4M TOP Ø 76 MM	7308	30000.00	1 N

For mounting info refer TDS. Also available in ABC (Anti-Bacterial & Beach Coating) against MOQ.



BASE COVER

Aesthetically designed decorative pole base cover, enhancing the appearance of the pole.

Item Description	HSN Code	MRP Rs. Per Unit (incl. of all taxes)	Case Lot No. of unit/s
STARK Decorative Pole Base Cover	7308	8500.00	1 N

For mounting info refer TDS. Also available in ABC (Anti-Bacterial & Beach Coating) against MOQ.

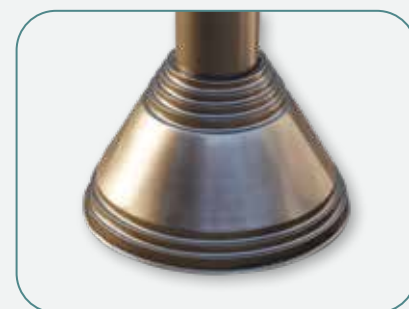

BANNER ARMS

Aesthetically designed decorative Banner arms, enhancing the appearance of the pole.

Item Description	HSN Code	MRP Rs. Per Unit (incl. of all taxes)	Case Lot No. of unit/s
BANNER ARM SINGLE	7308	3900.00	1 N
BANNER ARM DOUBLE	7308	7250.00	1 N

For mounting info refer TDS

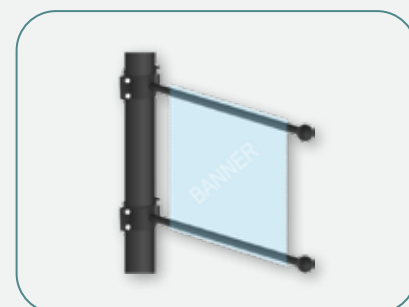

Outdoor Luminaires

LANDSCAPE LIGHTS

MUSHROOM LED BOLLARD

New generation, energy saving, environmental friendly, long life aesthetically designed IP 54 die-cast aluminium landscape luminaire for downward lighting with high power LED as light source.

Item Description	HSN Code	MRP Rs. Per Unit (incl. of all taxes)	Case Lot No. of unit/s
MUSHROOMBL16WLED757SSYMTOPC	9405	14250.00	1 N
MUSHROOMBL16WLED730SSYMTOPC	9405	14250.00	1 N

For mounting info refer TDS



BAMBOO LED BOLLARD

New generation, energy saving, environmental friendly, long life aesthetically designed aluminium landscape IP 65 luminaire for diffused lighting with high power LED as light source.

Item Description	HSN Code	MRP Rs. Per Unit (incl. of all taxes)	Case Lot No. of unit/s
BAMBOOBLS8WLED830PSYMTOPC	9405	6500.00	4 N
BAMBOOBLS8WLED857PSYMTOPC	9405	6500.00	4 N
BAMBOOBL8WLED830SSYMTOPCM	9405	8500.00	4 N
BAMBOOBL8WLED857SSYMTOPCM	9405	8500.00	4 N

For mounting info refer TDS



CONE LED BOLLARD

IP 65 Cone series acts as an imposing street furniture. The elegant yet minimalistic design acts a silent observer and giving light, diffuser at the upper portion adds functional value into landscape environment.

Item Description	HSN Code	MRP Rs. Per Unit (incl. of all taxes)	Case Lot No. of unit/s
CONEBLS8WLED830PSYMTOPC	9405	6900.00	4 N
CONEBLS8WLED857PSYMTOPC	9405	6900.00	4 N
CONEBL8WLED830PSYMTOPCM	9405	9400.00	4 N
CONEBLS8WLED857PSYMTOPCM	9405	9400.00	4 N

For mounting info refer TDS



CONE NXG LED BOLLARD

Cone NXG series acts as an imposing street furniture with touch of aesthetic. Innovative design with uniformly lit diffuser at the upper portion acts a beacon of path guidance in a landscape environment with robust IP 65 rating.

Item Description	HSN Code	MRP Rs. Per Unit (incl. of all taxes)	Case Lot No. of unit/s
CONENXGBLS8WLEDPSYM830TOPC	9405	7500.00	4 N
CONENXGBLS8WLEDPSYM857TOPC	9405	7500.00	4 N
CONENXGBLS8WLEDPSYM830TOPCM	9405	10500.00	4 N
CONENXGBLS8WLEDPSYM857TOPCM	9405	10500.00	4 N

For mounting info refer TDS



MOUNT LED BOLLARD

Sturdy IP 65 LED Bollard with excellent light out put through its PMMA window ensuring maximum illumination aspect in surrounding.

Item Description	HSN Code	MRP Rs. Per Unit (incl. of all taxes)	Case Lot No. of unit/s
MOUNTBL10WLED830PSYMTOPMMA	9405	9500.00	4 N
MOUNTBL10WLED857PSYMTOPMMA	9405	9500.00	4 N
MOUNTBL10WLED830PSYMTOPMMAM	9405	10900.00	4 N
MOUNTBL10WLED857PSYMTOPMMAM	9405	10900.00	4 N

For mounting info refer TDS



MINI MOUNT LED BOLLARD

Sturdy IP 65 LED Bollard with excellent light out put through its sleek PMMA window ensuring maximum illumination aspect in surrounding.

Item Description	HSN Code	MRP Rs. Per Unit (incl. of all taxes)	Case Lot No. of unit/s
MINIMOUNTBL10WLED830PSYMTOPMMAS	9405	6750.00	4 N
MINIMOUNTBL10WLED857PSYMTOPMMAS	9405	6750.00	4 N
MINIMOUNTBL10WLED830PSYMTOPMMA	9405	9500.00	4 N
MINIMOUNTBL10WLED857PSYMTOPMMA	9405	9500.00	4 N
MINIMOUNTBL10WLED830PSYMTOPMMAM	9405	10900.00	4 N
MINIMOUNTBL10WLED857PSYMTOPMMAM	9405	10900.00	4 N

For mounting info refer TDS



UFO LED BOLLARD

Contemporary UFO shape design IP 65 LED bollard with minimum upward light component, ensuring excellent distribution and high system lumen efficacy.

Item Description	HSN Code	MRP Rs. Per Unit (incl. of all taxes)	Case Lot No. of unit/s
UFOBLS10WLED830PSYMTOPC	9405	9500.00	4 N
UFOBLS10WLED857PSYMTOPC	9405	9500.00	4 N
UFOBLS10WLED830PSYMTOPCM	9405	10900.00	4 N
UFOBLS10WLED857PSYMTOPCM	9405	10900.00	4 N

For mounting info refer TDS



TURIN LED BOLLARD

Unique concept LED Bollard in IP 66 to ensure sustainable performance in all sections and aesthetics which keeps the surrounding lively.

Item Description	HSN Code	MRP Rs. Per Unit (incl. of all taxes)	Case Lot No. of unit/s
TURINBLS10WLED830PSYMTOPC	9405	10000.00	4 N
TURINBLS10WLED857PSYMTOPC	9405	10000.00	4 N

For mounting info refer TDS. Option of 3000 K CCT is available against MOQ



Outdoor Luminaires

LANDSCAPE LIGHTS

CROSSWAY

A light fixture which ensures safety to pedestrians on the Zebra Crossings on important and busy intersections of a City. IP 66 and PDC body for superb performance for long time.

Item Description	HSN Code	MRP Rs. Per Unit (incl. of all taxes)	Case Lot No. of unit/s
CROSSWAYSLS150WLED722PASYTOTGWH	9405	21300.00	2 N
CROSSWAYSLS150WLED730PASYTOTGWH	9405	21300.00	2 N
CROSSWAYSLS150WLED757PASYTOTGWH	9405	21300.00	2 N

Suitable for side entry thru arm OD 40 mm - 60 mm



GRANDEUR LED LIGHT COLUMN

LED Light Column spreads uniform lighting all around the pathway. Offered in 3 m and 4 m height in cylindrical shape.

Item Description	HSN Code	MRP Rs. Per Unit (incl. of all taxes)	Case Lot No. of unit/s
GRANDEURCLS36W830PSYMBOLPC	9405	45000.00	1 N
GRANDEURCLS36W857PSYMBOLPC	9405	45000.00	1 N
GRANDEURCLS72W830PSYMBOLPC	9405	68500.00	1 N
GRANDEURCLS72W857PSYMBOLPC	9405	68500.00	1 N

For mounting info refer TDS



EROS LED POST TOP

Aesthetically designed IP 66 LED post Top with aluminium enclosure, powered with high power LEDs as light source and die casted heat sink exhibiting classic Victorian look with symmetrical light distribution, suspended mounting arrangement and excellent heat dissipation for long life.

Item Description	HSN Code	MRP Rs. Per Unit (incl. of all taxes)	Case Lot No. of unit/s
EROSPT72WLED730PSYMTOPC	9405	30000.00	1 N
EROSPT72WLED757PSYMTOPC	9405	30000.00	1 N
EROSPT90WLED730PSYMTOPC	9405	34500.00	1 N
EROSPT90WLED757PSYMTOPC	9405	34500.00	1 N
EROSPT120WLED730PSYMTOPC	9405	41000.00	1 N
EROSPT120WLED757PSYMTOPC	9405	41000.00	1 N

For mounting info refer TDS



BUDZ SOLAR LED BOLLARD

IP65 LED Solar bollard with built-in solar panel, LED Light and Lithium battery with charge controller.

Item Description	HSN Code	MRP Rs. Per Unit (incl. of all taxes)	Case Lot No. of unit/s
BUDZ 1 W 5700 K Solar Bollard Light	8541	8900.00	6 N

For mounting info refer TDS



VILLA SOLAR LED GATE LIGHT

IP65 LED Solar pillar light with built-in Solar panel, LED Light and Lithium battery with charge controller.

Item Description	HSN Code	MRP Rs. Per Unit (incl. of all taxes)	Case Lot No. of unit/s
VILLA 1 W 5700 K Solar Gate Light	8541	8000.00	12 N

For mounting info refer TDS



EROS DECORATIVE ARMS

Family of Decorative Arms in different designs, shaped and lengths to compliment the EROS LED Post Tops and Poles Family.

Item Description	HSN Code	MRP Rs. Per Unit (incl. of all taxes)	Case Lot No. of unit/s
Orbit S Round Arm for Pole	7308	14000.00	1 N
For mounting info refer TDS. Ask sales person for more details			



EROS DECORATIVE ARMS

Family of Decorative Arms in different designs, shaped and lengths to compliment the EROS LED Post Tops and Poles Family.

Item Description	HSN Code	MRP Rs. Per Unit (incl. of all taxes)	Case Lot No. of unit/s
Orbit D Round Arm for Pole	7308	25000.00	1 N
For mounting info refer TDS. Ask sales person for more details			



EROS DECORATIVE ARMS

Family of Decorative Arms in different designs, shaped and lengths to compliment the EROS LED Post Tops and Poles Family.

Item Description	HSN Code	MRP Rs. Per Unit (incl. of all taxes)	Case Lot No. of unit/s
Orbit Plus S Round Arm for Pole	7308	18000.00	1 N
For mounting info refer TDS. Ask sales person for more details			

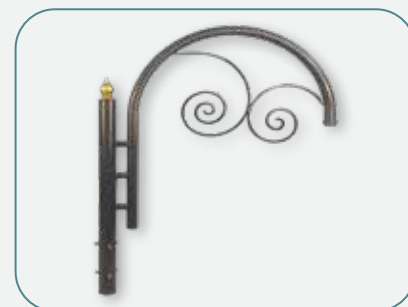

EROS DECORATIVE ARMS

Family of Decorative Arms in different designs, shaped and lengths to compliment the EROS LED Post Tops and Poles Family.

Item Description	HSN Code	MRP Rs. Per Unit (incl. of all taxes)	Case Lot No. of unit/s
Orbit Plus D Round Arm for Pole	7308	34000.00	1 N
For mounting info refer TDS. Ask sales person for more details			



EROS CASTING POLES

Family of Decorative Casting poles in different designs, shaped and heights to compliment the EROS LED Post Top family. These poles can infuse life into roads of high importance and visibility.

Item Description	HSN Code	MRP Rs. Per Unit (incl. of all taxes)	Case Lot No. of unit/s
EROSPOLET01025M	9405	46900.00	1 N
EROSPOLET01035M	9405	56280.00	1 N
EROSPOLET01060M	9405	73700.00	1 N
For mounting info refer TDS. Ask sales person for more details			



Outdoor Luminaires

LANDSCAPE LIGHTS

EROS CASTING POLES

Family of Decorative Casting poles in different designs, shaped and heights to compliment the EROS LED Post Top family. These poles can infuse life into roads of high importance and visibility.

Item Description	HSN Code	MRP Rs. Per Unit (incl. of all taxes)	Case Lot No. of unit/s
EROSPOLET02030M	9405	61640.00	1 N
EROSPOLET02040M	9405	68340.00	1 N
EROSPOLET02060M	9405	87100.00	1 N

For mounting info refer TDS. Ask sales person for more details



EROS CASTING POLES

Family of Decorative Casting poles in different designs, shaped and heights to compliment the EROS LED Post Top family. These poles can infuse life into roads of high importance and visibility.

Item Description	HSN Code	MRP Rs. Per Unit (incl. of all taxes)	Case Lot No. of unit/s
EROSPOLET03030M	9405	30820.00	1 N
EROSPOLET03040M	9405	36180.00	1 N
EROSPOLET03060M	9405	50920.00	1 N
EROSPOLET03080M	9405	68340.00	1 N

For mounting info refer TDS. Ask sales person for more details



GLITZO SOLAR LED BULK HEAD

IP65 LED Solar bulk head light with built-in Solar panel, LED Light and Lithium battery with charge controller and PIR sensor.

Item Description	HSN Code	MRP Rs. Per Unit (incl. of all taxes)	Case Lot No. of unit/s
GLITZO 4 W 5700 K Solar Bulkhead For mounting info refer TDS	8541	9500.00	12 N



FIORIO SOLAR LED POST TOP

IP65 LED Solar post top with built-in Solar panel, LED light and Lithium battery with charge controller and Remote Control to select 32 lighting mode.

Item Description	HSN Code	MRP Rs. Per Unit (incl. of all taxes)	Case Lot No. of unit/s
FIORIO 20 W 5700 K Solar Post Top For mounting info refer TDS	8541	51000.00	2 N



MANOR SOLAR LED POST TOP

IP65 LED Solar post top with built-in Solar panel, LED light and Lithium battery with charge controller and 2 PIR sensors with 360° coverage.

Item Description	HSN Code	MRP Rs. Per Unit (incl. of all taxes)	Case Lot No. of unit/s
MANOR 20 W 5700 K Solar Post Top For mounting info refer TDS	8541	49000.00	1 N



QUADRA SOLAR LED POST TOP

Quadra Solar Post Top is specially designed with Mono Crystalline Solar PV Module fitted on vertical surface of pole, Maintenance free Lithium Ferro Phosphate (LiFeP04) battery integrated inside the Extruded Aluminium Section of pole with corrosion resistant PU Paint applied on the pole. The Solar module is placed vertically on all four sides to get maximum sunlight for charging the battery bank. The elegant looking Luminaire is Aluminium Die Cast with Poly Carbonate diffuser is to install on the Pole Top.

Item Description	HSN Code	MRP Rs. Per Unit (incl. of all taxes)	Case Lot No. of unit/s
Quadra Solar Post Top For mounting info refer TDS	8541	On Request	1 N

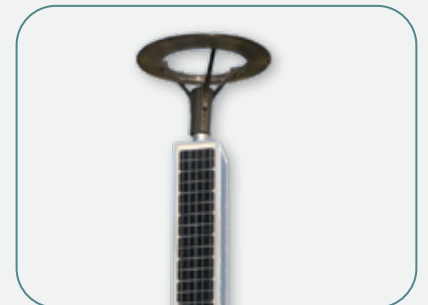



SKILINE PLUS

High power color changing & monochromatic LED projector for super distance lighting with Intelligent logarithmic control technology.

Item Description	HSN Code	MRP Rs. Per Unit (incl. of all taxes)	Case Lot No. of unit/s
SKILINE PLUS 600 W DMX	9405	On Request	1 N
SKILINE PLUS 600 W	9405	On Request	1 N
SKILINE PLUS 500 W DMX	9405	On Request	1 N
SKILINE PLUS 500 W	9405	On Request	1 N
SKILINE PLUS 400 W DMX	9405	On Request	1 N
SKILINE PLUS 400 W	9405	On Request	1 N
SKILINE PLUS 300 W DMX	9405	On Request	1 N
SKILINE PLUS 300 W	9405	On Request	1 N
SKILINE PLUS 200 W DMX	9405	On Request	1 N
SKILINE PLUS 200 W	9405	On Request	1 N



RANGER

Excellency steered color changing & monochromatic LED projector with unique design, delivering rich & saturated colors.

Item Description	HSN Code	MRP Rs. Per Unit (incl. of all taxes)	Case Lot No. of unit/s
RANGER 120 W DMX	9405	On Request	1 N
RANGER 120 W	9405	On Request	1 N
RANGER 90W DMX	9405	On Request	1 N
RANGER 90 W	9405	On Request	1 N
RANGER 70 W DMX	9405	On Request	1 N
RANGER 70 W	9405	On Request	1 N
RANGER 45 W DMX	9405	On Request	1 N
RANGER 45 W	9405	On Request	1 N
RANGER 30 W DMX	9405	On Request	1 N
RANGER 30 W	9405	On Request	1 N
RANGER 22 W DMX	9405	On Request	1 N
RANGER 22 W	9405	On Request	1 N



COMPASS

High light intensity empowered color changing & monochromatic compact LED projector with polarized light design & intelligent logarithmic control technology.

Item Description	HSN Code	MRP Rs. Per Unit (incl. of all taxes)	Case Lot No. of unit/s
COMPASS 180 W DMX	9405	On Request	1 N
COMPASS 180 W	9405	On Request	1 N
COMPASS 150 W DMX	9405	On Request	1 N
COMPASS 150 W	9405	On Request	1 N
COMPASS 130 W DMX	9405	On Request	1 N
COMPASS 130 W	9405	On Request	1 N
COMPASS 85 W DMX	9405	On Request	1 N
COMPASS 85 W	9405	On Request	1 N
COMPASS 40 W DMX	9405	On Request	4 N
COMPASS 40 W	9405	On Request	4 N
COMPASS 28 W DMX	9405	On Request	4 N
COMPASS 30 W	9405	On Request	4 N
COMPASS 23 W DMX	9405	On Request	4 N
COMPASS 23 W	9405	On Request	4 N



Outdoor Luminaires

COLORSCAPE LIGHTS

MARINA

High light intensity empowered color changing & monochromatic LED under water fountain light with polarized light design & intelligent logarithmic control technology.

Item Description	HSN Code	MRP Rs. Per Unit (incl. of all taxes)	Case Lot No. of unit/s
MARINALUMO MINI	9405	On Request	8 N
MARINALUMO MIDI	9405	On Request	8 N
MARINALUMO MAXI	9405	On Request	8 N
MARINASHINE MINI	9405	On Request	8 N
MARINASHINE MIDI	9405	On Request	8 N
MARINASHINE MAXI	9405	On Request	8 N

External driver to be ordered separately



LINEATE INT

Stylish & modern linear color changing & monochromatic wall grazer with multi angle lens design to meet the demands of various lighting design outlook.

Item Description	HSN Code	MRP Rs. Per Unit (incl. of all taxes)	Case Lot No. of unit/s
LINEATE INT 80 W DMX	9405	On Request	3 N
LINEATE INT 80 W	9405	On Request	3 N
LINEATE INT 60 W DMX	9405	On Request	3 N
LINEATE INT 60 W	9405	On Request	3 N
LINEATE INT 40 W DMX	9405	On Request	3 N
LINEATE INT 40 W	9405	On Request	3 N

1 m Length.

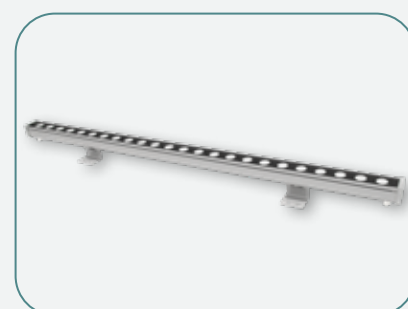

LINEATE

Stylish & modern linear color changing & monochromatic wall grazer with multi angle lens design to meet the demands of various lighting design outlook.

Item Description	HSN Code	MRP Rs. Per Unit (incl. of all taxes)	Case Lot No. of unit/s
LINEATE 40 W DMX	9405	On Request	3 N
LINEATE 40 W	9405	On Request	3 N
LINEATE 24 W DMX	9405	On Request	3 N
LINEATE 24 W	9405	On Request	3 N
LINEATE 12 W DMX	9405	On Request	3 N
LINEATE 12 W	9405	On Request	3 N

1 m Length for 40 W, 24 W. 50 cm Length for 12 W. External driver to be ordered separately

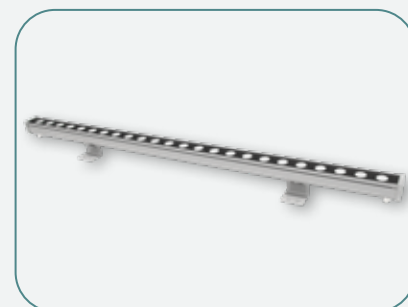

ENGROSS

Color changing & monochromatic buried uplighter ideal for uplighting facades, columns & features with multiple optics & extensive pallet of colors.

Item Description	HSN Code	MRP Rs. Per Unit (incl. of all taxes)	Case Lot No. of unit/s
ENGROSS 40 W DMX	9405	On Request	1 N
ENGROSS 40 W	9405	On Request	1 N
ENGROSS 28 W DMX	9405	On Request	1 N
ENGROSS 30 W	9405	On Request	1 N
ENGROSS 16 W DMX	9405	On Request	1 N
ENGROSS 16 W	9405	On Request	1 N
ENGROSS 13 W	9405	On Request	1 N



JETA QUANTO PLUS

Mono colour flood light luminaire offered in Mono – Red, Green, Blue and Warm White Colour. Pressure Die Cast aluminium body and Clear PC cover, and standard beam angle of 30Deg. Aesthetic consistency in multi purpose application like column lighting, tree up-lighting, statue accentuation etc.

Item Description	HSN Code	MRP Rs. Per Unit (incl. of all taxes)	Case Lot No. of unit/s
JETAQUANTOPLUSFLS50WLEDREDP30DPC	9405	8500.00	10 N
JETAQUANTOPLUSFLS50WLEDBLUEP30DPC	9405	8500.00	10 N
JETAQUANTOPLUSFLS50WLEDGREENP30DPC	9405	8500.00	10 N
JETAQUANTOPLUSFLS50WLED730P30DPC	9405	8500.00	10 N

For mounting info refer TDS



ADORN

Monochromatic buried uplighter ideal for uplighting landscape, facades, columns & features with multiple optics & saturated tones of white.

Item Description	HSN Code	MRP Rs. Per Unit (incl. of all taxes)	Case Lot No. of unit/s
ADORN 6 W	9405	On Request	8 N

External driver to be ordered separately



ADORN MINI

Monochromatic buried uplighter ideal for uplighting landscape, facades, columns & features with multiple optics & saturated tones of white.

Item Description	HSN Code	MRP Rs. Per Unit (incl. of all taxes)	Case Lot No. of unit/s
ADORN MINI 2 W	9405	On Request	24 N

External driver to be ordered separately



FLEXISTRIP

IP 67 rated flexible LED strip to add great color & dramatic effects with extensive pallet of colors.

Item Description	HSN Code	MRP Rs. Per Unit (incl. of all taxes)	Case Lot No. of unit/s
FLEXISTRIP 36 W DMX	9405	On Request	1 N
FLEXISTRIP 36 W	9405	On Request	1 N
FLEXISTRIP 72 W DMX	9405	On Request	1 N
FLEXISTRIP 72 W	9405	On Request	1 N

5 m Length. External driver to be ordered separately



DMX CONTROLLER

The Stand Alone DMX 512 controller can be used to control a wide variety of different DMX systems from RGB/RGBW to more advanced moving and color mixing luminaires, DMX audio players and fountains. The dual channel DMX 512 controller comes with a variety of features including RTC/calendar, Ethernet facilities, dry contact port triggering, multi-zone programming and SD memory card. The lighting levels, colors and effects can be programmed from a PC using the Havells DMX software.

Item Description	HSN Code	MRP Rs. Per Unit (incl. of all taxes)	Case Lot No. of unit/s
DMX Controller	8537	On Request	1 N



For Colorscape solution kindly consult our local branch representative as additional accessories like External Drivers, DMX Controllers, Amplifiers, IP rated Connectors, Address Writers, Channel profile etc. are to be ordered for dynamic effect lighting.



ALL-IN-ONE SOLAR STREET LIGHT NG SERIES

NG Series AIO Solar Street Light is made with High Efficiency Mono Crystalline Solar PV Module, Lithium Ferro Phosphate battery with in-built BMS technology, High Efficacy LED, MPPT Solar Charge Controller and Aluminium Extruded body & is specially programmed to automatically control the dimming and brightness of light, which increases the backup time.

Item Description	HSN Code	MRP Rs. Per Unit (incl. of all taxes)	Case Lot No. of unit/s
SOLAR AIO 15 W	9405	55000.00	1 N
SOLAR AIO 20 W	9405	65000.00	1 N
SOLAR AIO 24 W	9405	70000.00	1 N
SOLAR AIO 30 W	9405	90000.00	1 N
SOLAR AIO 40 W	9405	95000.00	1 N
SOLAR AIO 60 W	9405	115000.00	1 N



Note: Above prices do not include Pole cost, installation cost, freight cost, etc. Kindly check pole OD for AIO fitting before installation. Other products viz. Stand alone with LMLA/Gel, Stand alone with LFP, Solar Mini mast shall be provided upon request.



GENERAL CONDITIONS OF BUSINESS

- Prices are in Indian ₹ (Inclusive of GST).
- All prices are subject to Havells general terms & conditions of business.
- Manufacturing warranty period is dependent on life class, application, electrical infrastructure, etc. Kindly check with Havells sales representative for product warranty details.
- Warranty is void on luminaires if:
 - Earthing is not provided.
 - Failure due to surges, high voltage, improper installation and wrong application.
- No warranty on SPD.
- Images shown here are for representation only and may vary from actual product.
- Orders should be placed in case lot multiples & against the confirmed purchase order only.
- Continuous design improvement is a routine practice at Havells. Data provided may change without any prior intimation. Customers are advised to reconfirm the data or product dimensions before purchase with our local offices.
- This Price List supersedes all our previous Price Lists.
- Prices are subject to change without notice.
- Company reserves the right to issue amendments, which may arise due to any errors in the price list.

HSN Code	Products Included	GST Applicable
9405	LED Fixtures	18%
9405	Conventional Fixtures	18%
9405	LED Driver	18%
8543	Solar Street Lights/Mini Mast	12%
7308	Galvanized products	18%
8537	DMX Controller & Accessories	18%
8539	Non-LED Lamps	18%

Although every effort has been made to ensure accuracy in the compilation of the technical detail within this publication, however current details should therefore be checked with Havells. Specifications and performance data are constantly changing. Copyright Subsists. Imitation of trade dress, graphics and color scheme of this document is a punishable offence.

REGIONAL & BRANCH OFFICES:

NORTH - REGIONAL OFFICE: Corporate Office: QRG Towers, 2D, Sector-126, Expressway, Noida-201304, Tel: 0120-3331000, **Delhi:** 011-47676700, 23888200, **Chandigarh:** 0172-4232400-401, **Dehradun:** 0135-6670202, **Haldwani:** 05946-222935/222933, **Noida / Haryana:** 0120-3331000, **Ludhiana:** 0161-4676000/24, **Amritsar:** 0183-5202400/401, **Jammu:** 0191-2478330, 2479330, **Sri Nagar:** 0194-2459248, **Jaipur:** 0141-4211000, 4211011, **Jodhpur:** 9214201640/41, **Lucknow:** 0522- 4921600/4921649, **Kanpur:** 0512-6710400

EAST - REGIONAL OFFICE: Kolkata: ICC Tower, 5th Floor, 4 India Exchange Place, Kolkata-700001, Tel: 033-40129851/52, **Bhubaneshwar:** 0674-6668101/102/103/104, **Guwahati:** 0361-2458923, 2134521, **Siliguri:** 0353-2525907, **Ranchi:** 0651-2244861, 2244862, 2244864, 2244868, 2244869, **Jamshedpur:** 0657-6542492, 09234369436, **Patna:** 0612-2207221, 2207222, 2207223, 2655518

WEST - REGIONAL OFFICE: Mumbai: 14th Floor, Unit No. 1405 – 1408, Lodha Supremus, I - Think Techno Campus, Kanjurmarg (East), Mumbai-400 042. Tel: 022 - 67298600-602, **Ahmedabad:** 079-40061111, 40060738/740, **Indore:** 0731-4219444/4219422, 0731-2572340, **Rajkot:** 0281-2481112, 2921212, **Nagpur:** 0712-2240932, 2242692, 2242699 **Pune:** 020-26056175-76, **Raipur:** 0771-4243400/01, **Surat:** 0261-6131001, 9099056612, **Jabalpur:** 0761-4064491, **Bhopal:** 0755-4271544, 0755-4011025

SOUTH - REGIONAL OFFICE: Chennai: 1st Floor, Khivraj Complex-1, No. 480, Annasalai, Nandanam, Chennai - 600035, Tel: 044-42280600, 605, **Bangalore:** 080-49075000, **Coimbatore:** 0422-4550200/282, **Hyderabad:** 040-27533372, 27533355, 27533632, **Cochin:** 0484-4099000, **Calicut:** 0495-4019193/4/5, **Trivandrum:** 0471-4015323, **Vizag:** 0891-6514339, **Vijayawada:** 0866-2546161/62/67/68/69, **Hubli:** 0836-4248660

Representative Offices: • Goa • Solapur • Gwalior • Kathmandu • Bhopal • Kolhapur • Vadodara



Havells India Ltd.

QRG Towers, 2D, Sector -126, Expressway, Noida - 201 304 (UP), Ph. +91-120-3331000, E-mail: marketing@havells.com, www.havells.com
Customer Care No. 08045 77 1313
Join us on Facebook at www.facebook.com/havells and share your ways to save the planet!
CIN - L31900DL1983PLC016304.



HAVELLS



HAVELLS

PROFESSIONAL LIGHTING SOLUTION
INDUSTRIAL LIGHTS



Catalogue 2018

LED

HAVELLS INTRODUCTION



Havells India Limited is a leading Fast Moving Electrical Goods (FMEG) Company and a major power distribution equipment manufacturer with a strong global presence. Havells enjoys enviable market dominance across a wide spectrum of products, including Industrial & Domestic Circuit Protection Devices, Cables & Wires, Motors, Fans, Modular Switches, Home Appliances, Air Conditioners, Electric Water Heaters, Power Capacitors, CFL Lamps, Luminaires for Domestic, Commercial and Industrial Applications.

Today, Havells owns some of the most prestigious brands like Havells, Lloyd, Crabtree, Standard and Promptec. Its network constitutes of 4000 professionals, over 7575 dealers and 40 branches in the country. Our products are available in 40 countries. The company has twelve state-of-the-art manufacturing plants in India located at Haridwar, Baddi, Sahibabad, Faridabad, Assam, Alwar and Neemrana, manufacturing globally acclaimed products, synonymous with excellence and precision in the electrical industry.

The company pioneered the concept of exclusive brand showroom in the electrical industry with 'Havells Galaxy'. Today over 415 Havells Galaxies across the country are helping customers, both domestic and commercial, to choose from a wide variety of products for different applications. Havells became the first FMEG Company to offer door step service via its initiative 'Havells Connect'. Thanks to the quality of products and quicker service, it has minimum customer complaints and highest customer satisfaction.

Today, Havells alongwith its brands, have earned the distinction of being the preferred choice of electrical products for discerning individuals and industrial consumers both in India and abroad. Havells offers same quality products for both Indian and International markets. It is committed to keep powering the world with its state-of-the-art innovations and energy-efficient solutions. Currently over 90% of its product offerings are energy efficient and manufactured in-house.

Social and environmental responsibility has been at the forefront of Havells Operating Philosophy and as a result the company consistently contributes to socially responsible activities. For instance, the company is providing mid-day meal in government schools in Alwar district, covering more than 57000 students per day. The group company, QRG Healthcare runs a 140 bed hospital in Faridabad. In the past, the company has generously contributed to the society during various national calamities like the Bihar Flood, Tsunami and Kargil National Relief Fund, etc.

The essence of Havells' success lies in the expertise of its fine team of professionals, strong relationships with associates and the ability to adapt quickly & efficiently, coupled with the vision to always think ahead.

PLANTS INTRODUCTION



Neemrana Lighting Plant



Advanced technology cutting machine



Italian Robotised Box Bending Machines



Japanese Flexible CNC controlled steel fabrication process

Havells State of the art Luminaire Plant, Neemrana

CERTIFICATION



Havells lighting plant in Neemrana is spread over 30 acres of land with over 2,00,000 square feet of working space under a single roof. The plant has been made keeping in mind the global markets of Europe, US and the Middle East. Setting new benchmarks in the industry, this Havells plant will help bridge the technological divide between Europe and India when it comes to manufacturing high-end lighting luminaries.

Japanese flexible CNC controlled steel fabrication process for the accuracy in sheet punching & bending Italian robotised box bending machines to design complex enclosure shapes without human intervention Automated powder coating paint shop to minimize wastage & fast colour change Eco-friendly zero discharge plant Parabolic rolling machine for replicating complex and accurate forms and shapes Flexible assembly line Modern laboratories

Building customer confidence by providing a wide range of quality products and service through team work

BRIGHTEN YOUR WORLD WITH HAVELLS LED



HAVELLS

APPLICATIONS:

- General lighting
- Low energy indicators
- Signage
- Automotive Lighting
- Traffic Lights
- Text and Video Displays.
- Street Lights
- LED Television
- Communication
- Sensors
- Light Matter Interaction
- Pico Projector

LED: Light Emitting Diode LEDs are miniature Light Sources made of semi-conductor material, typically consisting of doped Gallium Nitride materials. They work on the principle of a p-n junction diode. When appropriate DC voltage is applied across the junctions, the diode is forward biased (on state) and the electrons combine with holes and energy is released in the form of visible light.

This effect is called electro luminescence and color of light is determined by the band gap of the semiconductor.

LED Lamp:

A LED lamp (also called LED bar or Illuminator) is a type of solid state lighting (SSL) device that uses light-emitting diodes (LEDs) as the source of light. They usually comprise clusters of LEDs in a suitable housing.

LEDs by nature emit light in a very small focused wavelength range that is characteristic of the energy band gap of the semiconductor. In order to overcome this, two primary methods of creating white light from LEDs are being used; combination of Red-Green-Blue LEDs and phosphor converted LEDs.

Why LED:

- Lower Energy Consumption
- Longer Lifetime
- Improved Robustness
- Smaller Size

Instant Start: LEDs are ideal for use in applications that are subject to frequent on-off cycling, unlike fluorescent lamps that burn out more quickly when cycled frequently or HID lamps that require a long time before restarting. Also LEDs and LED based luminaires can be dimmed easily. LED luminaires can be designed to focus its light at any desired beam angles (wide to ultra narrow) using small and compact lenses and mirrors. In comparison Incandescent and Fluorescent sources require large external reflector to achieve the same performance.

Environment Friendly - Does not Contain Mercury. Reduced CO2 emission.

LEDs are shock resistant being solid state components and hence accidental breaking during transportation and operations are eliminated.

PRODUCT CODE NOMENCLATURE

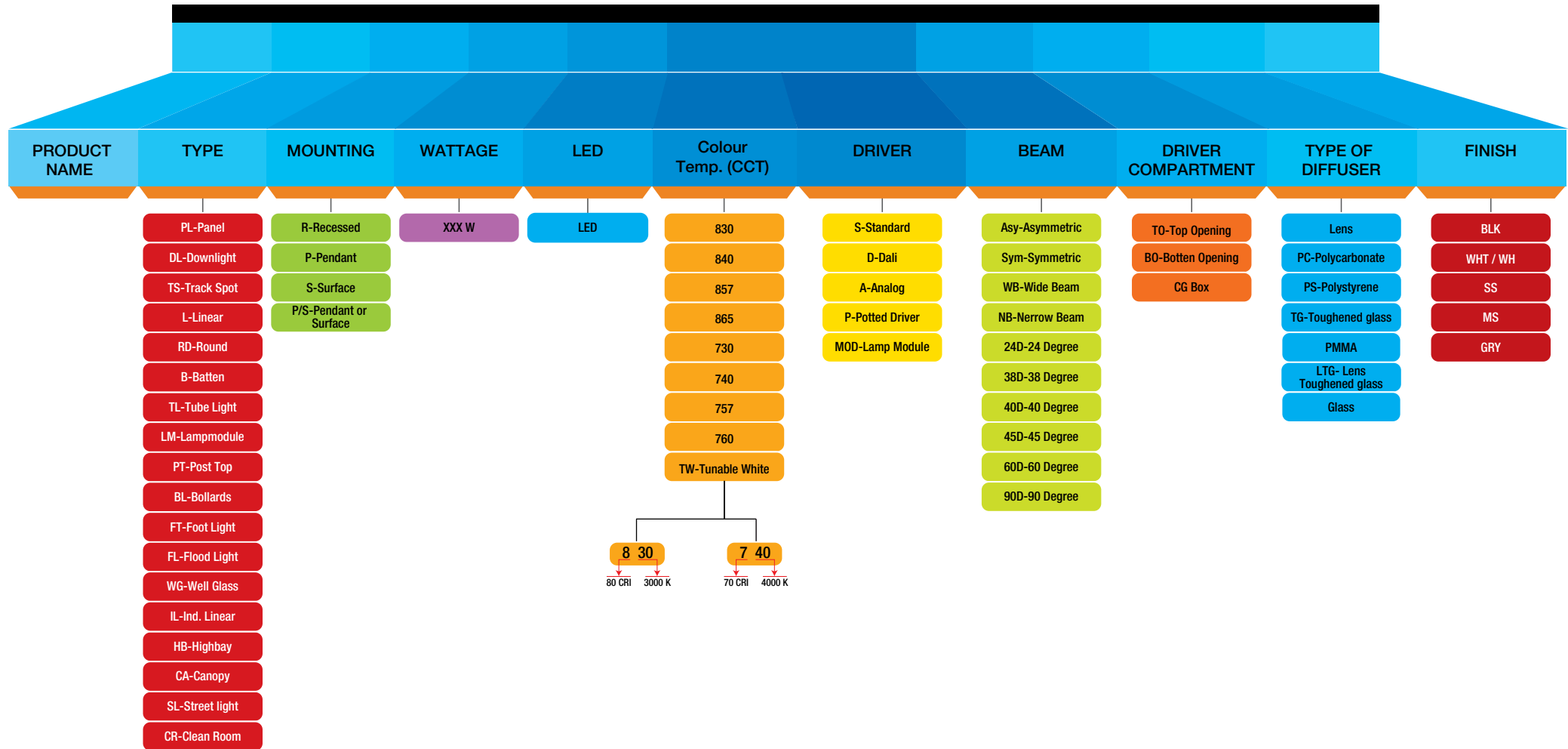

EXAMPLES:

PRODUCT NAME	TYPE	MOUNTING	WATTAGE	LED	CCT	DRIVER	BEAM	DRIVER COMPARTMENT	TYPE OF DIFFUSER	FINISH
BAYBRITESAUCERHP200WLED757WBTOLTG										
BAYBRITESAUCER	HB	P	200 W	LED	757	-	WB	TO	LTG	-
ENDURAPEARLSL15WLED757SASYTOPC										
ENDURAPEARL	SL	-	15 W	LED	757	S	ASY	TO	PC	-
VENUSNEOHE2X2PLR18-42WLED857MOD										
VENUSNEOHE2X2	PL	R	34 W	LED	857	S	-	-	-	-



TABLE OF CONTENTS

We at Havells believe that Landscape is the Fourth Dimension of architectures. Landscape lighting can divide and structure areas. It can act as guide and Direct. Proper landscape lighting Can emphasize and Present architecture of the building in Night time As a delight and also act as a security envelope. We understand that every aspect of light demands a treatment with Specific Light Applications. Welcome to Havells Landscape Range which will strive to do so.

Magnum LED 24 W	12-13
Magnum Grand	14-15
Magnum Retro	16-17
Endura Well Glass Neo TS IP66	18-19
Endura Highbrite Plus	20-21
Baybrite Saucer 80 W WOPD	22-23
Saucer Neo 100 W /120 W /150 W	24-25
Saucer Neo 180 W /200 W	26-27
Baybrite Flare 70 W /80 W	28-29
Valour Highbay 180 W /200 W	30-31



Industrial Lighting



MAGNUM LED 24 W Tubelight

Energy saving, environmental friendly, long life, corrosion resistant, impact proof, surface mounting IP65 luminaire with PC housing in opal finish suitable for wet location with high brightness LEDs.

PRODUCT SPECIFICATIONS

Features & Benefits

- Excellent efficacy & performance suitable for wall/ceiling mounting.
- Long life & photobiologically safe LED's
- High performance electronic driver ensures zero maintenance
- No harmful UV & IR radiations
- Environment friendly as it does not contain Mercury
- Instant light with low running temperatures
- Operating temperature: -10° C to +45° C
- Operating voltage range: 140 V - 270 V
- Average life $L_{70}B_{50}$: 50000 hours

Housing

Made up of corrosion resistant round shaped unbreakable polycarbonate body in opal finish.

Light source

High efficiency long life LED package in integral module with lumen efficacy of >130 lm/W and viewing angle of 120° to ensure better uniformity.

Optics

Reflector made of LEF pasted on Al. sheet (heat sink) on both sides of LED strip to enhance the lumen output and glare free uniform light distribution.

Electronic driver

Powered by an integral electronic driver (SMPS based constant current supply)

with Output Short-circuit / Open Circuit protection, Surge Voltage protection & other safety test as per IS:15885 Part 2/ Sec 13.

Mounting

Surface & suspended through 2 nos. SS spring clips & screws provided with fixture.

Applications

- Battery rooms
- Chilling plants
- Chemical factories
- Underground parkings
- Thermal power stations

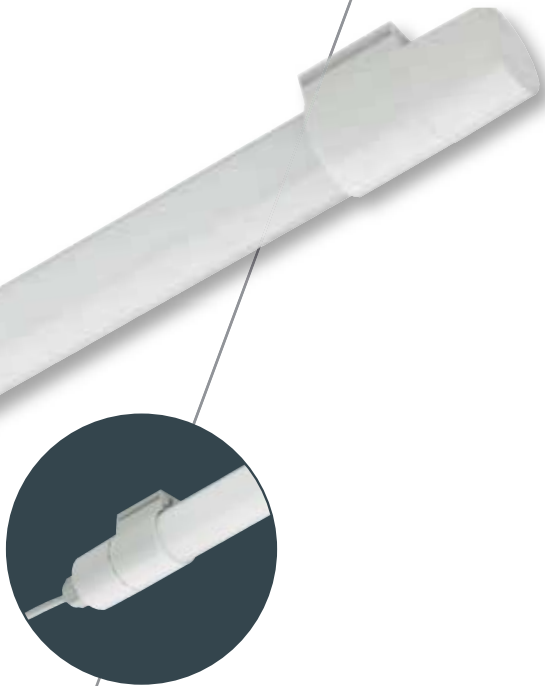

Green
LED | 24 W
Life **50000 hours** | HighEfficiency



TECHNICAL DATA

Ordering Code	System Power (W)	Nominal Voltage (V)	Mains Current (A)	Power Factor	Colour Temp. (CCT)	CRI (Ra)	System Lumens (lm)	Colour of Fixture	System Luminous Efficacy lm/W
MAGNUMILS24WLED857PC	24 W	240	0.110	≥0.90	5700 K	≥80	2050	Ivory	≥85

IS 10322 (Part 5/Sec 1): 2012



TECHNICAL DRAWING

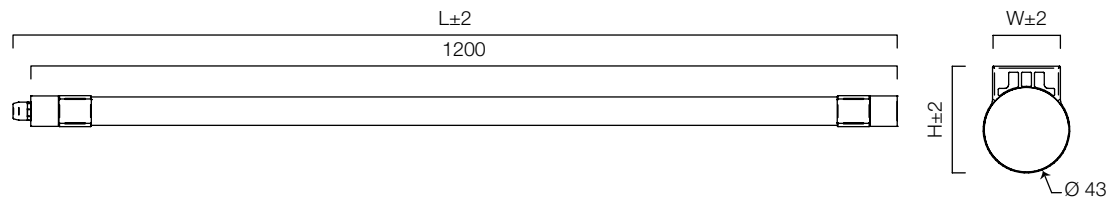

PHOTOMETRIC DRAWING

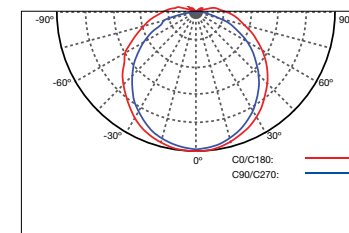

System Power	Length l (mm)	Width w (mm)	Height h (mm)
24 W	1227	34	53

All dimensions are in mm
Tolerance: ± 5 mm

MAGNUM GRAND

Tubelight

Energy saving, environmental friendly, long life, corrosion resistant, impact proof, surface mounting IP65 luminaire with PC housing & opal finish cover suitable for wet location. LEDs used as light source.

PRODUCT SPECIFICATIONS

Features & Benefits

- Excellent efficacy & performance suitable for wall/ceiling and suspended installation.
- Long life & photobiologically safe LED's
- High performance electronic driver ensures zero maintenance
- No harmful UV & IR radiations
- Environment friendly as it does not contain Mercury
- Instant light with low running temperatures
- Operating temperature:-10° C to 45° C
- Operating voltage range: 140 V - 270 V
- Average life $L_{70B_{50}}$: 50000 hours

Housing & Finish

Made up of scratch resistant unbreakable polycarbonate in grey finish. PG 11 cable gland is used for maintaining ingress protection.

Light source

High efficiency long life LED package in integral module with lumen efficacy of >130 lm/W and viewing angle of 120° to ensure better uniformity.

Cover

High quality polycarbonate diffuser in opal finish for glare free uniform light distribution, snap fitted to the housing.

Reflector

With power coated CRCA sheet acts as reflector and control gear tray.

Electronic driver

Powered by an integral electronic driver (SMPS based constant current supply) with low THD, Output Short-circuit / Open Circuit protection, Surge protection & Safety test as per IS:15885 Part 2/Sec 13.

Mounting

Surface & suspended through 2 nos. SS clamps & screws provided with fixture.

Applications

- Battery rooms
- Chilling plants
- Underground parkings
- Thermal power stations



Green
LED | 20 W / 40 W
Life **50000 hours** | High Efficiency



TECHNICAL DATA

Ordering Code	System Power (W)	Nominal Voltage (V)	Mains Current (A)	Power Factor	Colour Temp. (CCT)	CRI (Ra)	System Lumens (lm)	Colour of Fixture	System Luminous Efficacy lm/ W
MAGNUMGRANDILS20WLED857PC	20 W	240	0.085	≥0.95	5700 K	≥80	1700	Off White	≥85
MAGNUMGRANDILS40WLED857PC	40 W	240	0.175	≥0.95	5700 K	≥80	3400	Off White	≥85

IS 10322 (Part 5/Sec 1): 2012



TECHNICAL DRAWING

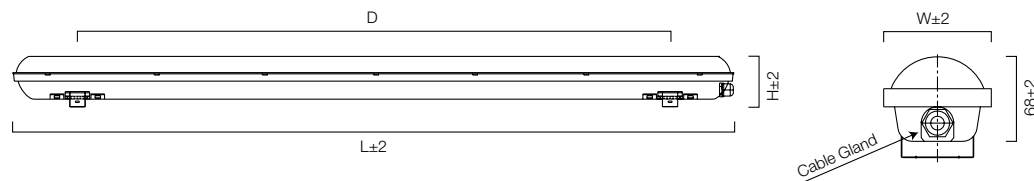

System Power	Length l (mm)	Width w (mm)	Height h (mm)	CD of mounting holes (d) (in mm)
20 W	590	86	73	380
40 W	1180	86	73	970

All dimensions are in mm
Tolerance: ± 5 mm

PHOTOMETRIC DRAWING

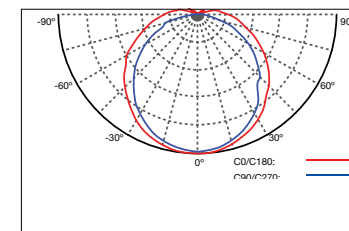

MAGNUM RETRO

(Single side connection)

Energy saving, environmental friendly, long life, corrosion resistant, impact proof, surface/suspended mounting luminaire with PC housing and linear ribbed PC cover for glare free light, suitable for T8 LED Tube with single side connection.



PRODUCT SPECIFICATIONS

Housing & Finish

Made up of corrosion resistant unbreakable polycarbonate.

Cover

Clear polycarbonate cover with better light dispersive internal reeds fix to the housing by means of SS toggles.

Lamp Holders

Push fit type white polycarbonate housing and ABS rotor with corrosion resistant brass contacts.

Light Source

Complete internal wiring suitable for retrofit LED tubelight with single side connections.

Optics

White power coated CRCA sheet used as Reflector.

Mounting

Surface/suspended mounting using SS Clip, for detail refer instalation sheet.

Applications

- Battery rooms
- Chilling plants
- Chemical factories
- Underground parkings
- Thermal power stations

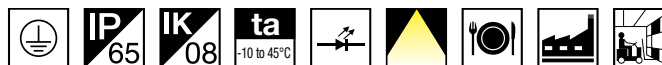



TECHNICAL DATA

Ordering Code	Nominal Voltage (V)	Lamp	Lamp Holder	LxWxH (in mm)
MAGNUMRETROILS1X18PC	250	1 x T8 LED Tube	G 13	1258 x 70 x 70
MAGNUMRETROILS2X18PC	250	2 x T8 LED Tube	G 13	1258 x 100 x 70

TECHNICAL DRAWING

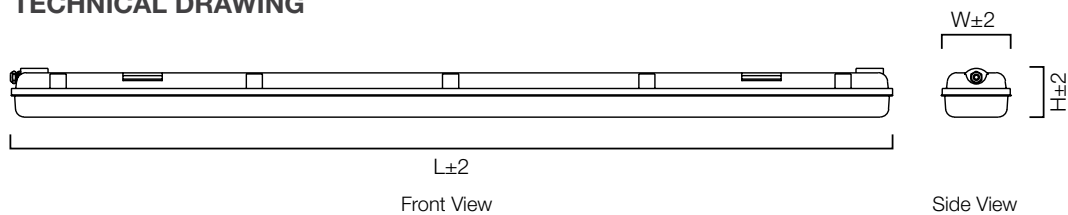

L±2
Front View

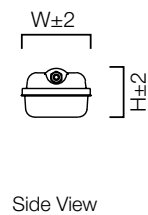

Side View

PHOTOMETRIC DRAWING

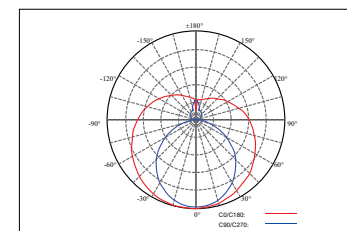

Lamp	Length l (mm)	Width w (mm)	Height h (mm)
1 x T8	1258	70	70
2 x T8	1258	100	70

All dimensions are in mm
Tolerance: ± 5 mm

ENDURA WELL GLASS NEO TS IP66

Environmental friendly, energy saving long life corrosion resistant, vertical surface mounting pressure die-cast aluminium housing and control gear compartment well glass luminaires with high power LED as light source.

PRODUCT SPECIFICATIONS

Features & Benefits

- Delivers excellent illumination & comfort in high ceiling areas
- Long life & photobiologically safe LED's
- High performance electronic driver ensures zero maintenance
- No harmful UV & IR radiations
- Environment friendly as it does not contain Mercury
- Instant light with low running temperatures
- Operating temperature:-10° C to +45° C
- Operating voltage range: 140 V - 270 V
- Average life $L_{70B_{50}}$: 50000 hours

Housing

Pressure die-cast aluminum alloy ADC12 housing (heat sink) for effective thermal

management, sturdiness & excellent corrosion resistant. 2 nos. cable gland M16 is provided at cable entry for maintaining Ingress protection and for providing loopin & loop-out facility.

Finish

Epoxy powder coated after phosphochromate treatment in metallic silver finish.

Light source

High efficiency long life LEDs with lumen efficacy of >120 lm/W with viewing angle 120° to ensure better uniformity of light distribution.

Cover

Polycarbonate diffuser in opal finish for glare free light distribution fixed to the housing with 5 nos. SS screws (For Detailed Photometric details, please refer LM 79 report & IES file).

Electronic driver

Integral, electronic driver with APFC, lower THD, Output Short Circuit Protection, Surge Voltage Protection upto 4kV, Over Voltage Protection & other safety test as per IS:15885 Part 2/Sec 13.

Mounting

Suspended by heavy duty eye-bolt hook provided with the fixture.

Allen grub screw is provided for locking the mounting eye-bolt.

Applications

- Industrial bays
- Cement factories
- Oil process locations
- Medium industrial units

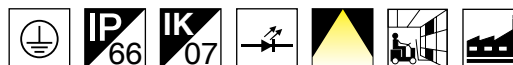

Green
LED | 26 W / 35 W / 40 W
Life **50000** hours | HighEfficiency



TECHNICAL DATA

Ordering Code	System Power (W)	Nominal Voltage (V~)	Mains Current (A)	Power Factor	Colour Temp. (CCT)	CRI (Ra)	System Lumens (lm)	Colour of Fixture	System Luminous Efficacy lm/W
ENDURAWELGLASSNEOTSWGP26WLED757SPC	26 W	240	0.115	≥0.95	5700 K	≥80	2730	Gray	≥105
ENDURAWELGLASSNEOTSWGP35WLED757SPC	35 W	240	0.150	≥0.95	5700 K	≥80	3500	Gray	≥100
ENDURAWELGLASSNEOTSWGP40WLED757SPC	40 W	240	0.180	≥0.95	5700 K	≥80	4000	Gray	≥100

IS 10322 (Part 5/Sec 1): 2012



Driver code: LSSCRX2400 for 26 W, LSSCRX2399 for 35 W, LSSCRX2398 for 40 W.

TECHNICAL DRAWING

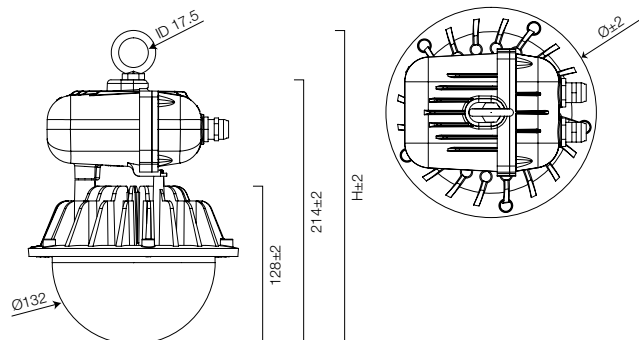

System Power	Ø (mm)	Width w (mm)
26 W / 35 W / 40 W	170	254

All dimensions are in mm
Tolerance: ± 5 mm

PHOTOMETRIC DRAWING

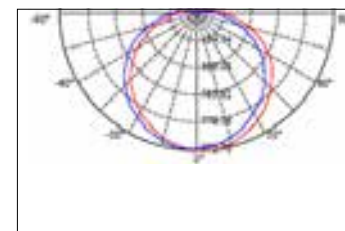

ENDURA HIGHBRITE PLUS

Energy saving, environment friendly & robust open type vertical Mediumbay Highbay LED IP54 luminaire with high power COB LED as light source.



PRODUCT SPECIFICATIONS

Features & Benefits

- Better lumens & longer lamp life
- High efficacy & lower power consumption
- Delivers high brightness & excellent illumination
- No harmful UV & IR radiations
- Environment friendly as it does not contain Mercury
- Instant light with low running temperatures
- Operating temperature: -10° C to +45° C
- Operating voltage range: 140 -270 V
- Average life $L_{70}B_{50}$: 50000 hours

Housing

Extruded aluminium housing (heat sink) for efficient thermal management, sturdiness & excellent corrosion resistance. Pressure die-

cast aluminium housing (ADC12/LM24) for controlgear. PG 7 gland is used for cable entry for maintaining ingress protection.

Finish

Control Gear housing is epoxy powder coated black after phosphochromate treatment whereas heat sink is anodised in black finish.

Light source

High efficiency long life COB LED with $Ra > 70$ and lumen efficacy of 120 lm/W with view angle of 120° to ensure better uniformity of light distribution.

Optics

Aluminium spun reflector sand blasted from inside and electrochemically brightened. Glass lens over COB for uniform distribution (For Detailed Photometric details, please refer LM 79 report & IES file).

Electronic driver

Powered by an In-built, electronic driver with APFC, lower THD, Open Circuit Protection, Surge Voltage Protection & other safety test as per IS 15885 Part-2/Sec 13.

Mounting

Suspended by means of heavy duty nickel plated, forged eye-bolt provided with the fixture. Nut is also provided in the casting to lock the eye-bolt.

Applications

- Cement & steel plants
- Ware houses
- Factories & assembly lines
- Toll plazas

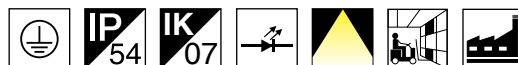

Green
LED | 50 W / 90 W / 150 W
Life **50000 hours | HighEfficiency**



TECHNICAL DATA

Ordering Code	System Power (W)	Nominal Voltage (V~)	Mains Current (A)	Power Factor	Colour Temp. (CCT)	CRI (Ra)	System Lumens (lm)	Colour of Fixture	System Luminous Efficacy lm/ W
ENDURAHIBRITEPLUSHP90WLED765S60DTOLENS	90 W	240	0.400	≥0.95	6500 K	≥70	9000	Black	≥100
ENDURAHIBRITEPLUSHP90WLED765S90DTOLENS	90 W	240	0.400	≥0.95	6500 K	≥70	9000	Black	≥100

IS 10322 (Part 5/Sec 1): 2012



With Potted Driver

ENDURAHIBRITEPLUSHP150WLED765P60DTOLENS	150 W	240	0.650	≥0.95	6500 K	≥70	15000	Black	≥100
ENDURAHIBRITEPLUSHP150WLED765P90DTOLENS	150 W	240	0.650	≥0.95	6500 K	≥70	15000	Black	≥100

Driver code: LSSLOX0175 for 90 W, LSSLOX0167 for 150 W.

TECHNICAL DRAWING

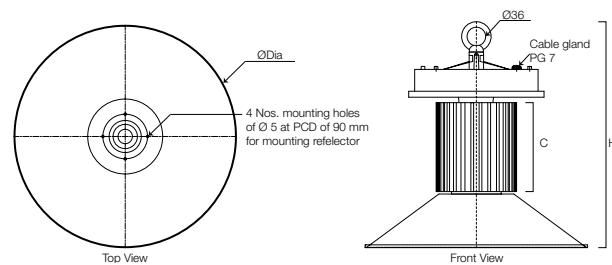

System Power	Ø (mm)	Width w (mm)
90 W	362	352
150 W	447	490

All dimensions are in mm
Tolerance: ± 5 mm

PHOTOMETRIC DRAWING

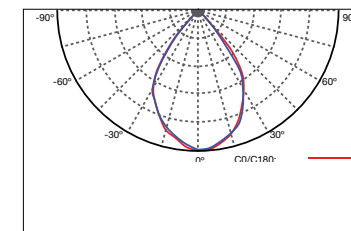

BAYBRITE SAUCER

80 W WOPD

Energy saving, environment friendly & robust Mediumbay / Highbay LED luminaire with high efficacy.



PRODUCT SPECIFICATIONS

Features & Benefits

- Better lumens & longer lamp life
- High efficacy & lower power consumption
- Delivers high brightness & excellent illumination
- No harmful UV & IR radiations
- Environment friendly as it does not contain Mercury
- Instant light with low running temperatures
- Operating temperature: -10° C to +45° C
- Operating voltage range: 140 -270 V
- Average life $L_{70}B_{50}$: 50000 hours

Housing

Aluminum alloy pressure die casted housing & control gear box for better heat dissipation and aesthetic appeal. M16 X1.5 gland is used for cable entry and loopin-loopout.

Finish

The fixture is epoxy powder coated with colour munshell grey finish.

Light source

High efficiency long life LEDs with lumen efficacy of >150 lm/W with view angle 120° to ensure better uniformity of light distribution.

Optics

High quality PC lens with optional narrow & wide beam angles for uniform distribution (For Detailed photometric data, please refer LM 79 report & IES file).

Cover

Tempered protective toughened glass, thermal shock and impact resistant fixed to the housing with SS screws.

Electronic driver

Built In, electronic driver with APFC, lower THD, Open Circuit Protection, Surge Voltage Protection upto 10 kV with Built In SPD & other safety test as per IS 15885 Part-2/ Sec 13.

Mounting

Suspended by means of heavy duty nickel plated, forged eye-bolt provided with the fixture.

Applications

- Cement & steel plants
- Ware houses
- Factories & assembly lines
- Toll plazas

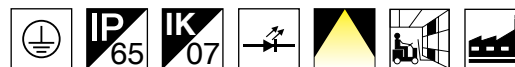

Green
LED | 80 W
Life **50000 hours** | HighEfficiency



TECHNICAL DATA

Ordering Code	System Power (W)	Beam Type	Nominal Voltage (V~)	Mains Current (A)	Power Factor	Colour Temp. (CCT)	CRI (Ra)	System Lumens (lm)	Colour of Fixture	System Luminous Efficacy lm/ W
BAYBRITESAUCERHBP80WLED757S60DTOLTG	80 W	Narrow Beam	240	0.350	≥0.95	5700 K	≥70	10500	Grey	≥130
BAYBRITESAUCERHBP80WLED757S90DTOLTG	80 W	Wide Beam	240	0.350	≥0.95	5700 K	≥70	10500	Grey	≥130

IS 10322 (Part 5/Sec 1): 2012



TECHNICAL DRAWING

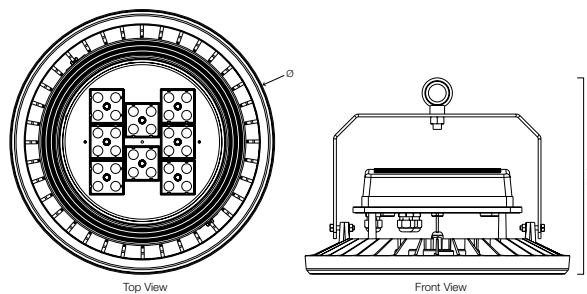

System Power	Ø (mm)	Width w (mm)
80 W / 120 W	380	230

All dimensions are in mm
Tolerance: ± 5 mm

PHOTOMETRIC DRAWING

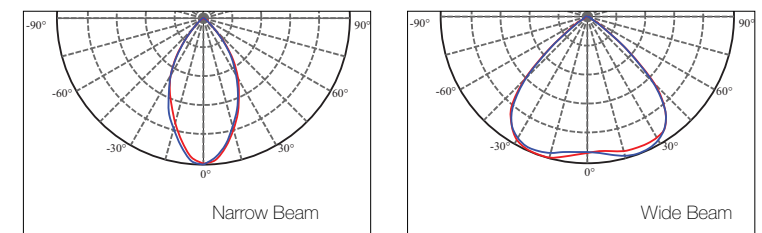

SAUCER NEO

100 W / 120 W / 150 W

Energy saving, environment friendly & robust Highbay/
Mediumbay LED IP65 luminaire with high efficacy.



PRODUCT SPECIFICATIONS

Features & Benefits

- Better lumens & longer lamp life
- High efficacy & lower power consumption
- Delivers high brightness & excellent illumination
- No harmful UV & IR radiations
- Environment friendly as it does not contain Mercury
- Instant light with low running temperatures
- Operating temperature: -10° C to +50° C
- Operating voltage range: 140 -270 V
- Average life $L_{70}B_{50}$: 50000 hours

Housing

Aluminum alloy pressure die casted housing for better heat dissipation and aesthetic appeal.

Finish

The housing is epoxy powder coated with colour munshell grey finish.

Light source

High efficiency long life LEDs with lumen efficacy of >150 lm/W with view angle 120° to ensure better uniformity of light distribution.

Optics

High quality PC lens with optional narrow & wide beam angles for uniform distribution (For Detailed photometric data, please refer LM 79 report & IES file).

Cover

Tempered protective toughened glass, thermal shock and impact resistant fixed to the housing with SS screws.

Electronic driver

Built In, electronic driver with APFC, lower THD, Open Circuit Protection, Surge Voltage Protection upto 10 kV with Built In SPD & other safety test as per IS 15885 Part-2/ Sec 13.

Mounting

Suspended by means of heavy duty nickel plated, forged eye-bolt provided with the fixture.

Applications

- Cement & steel plants
- Ware houses
- Factories & assembly lines
- Toll plazas

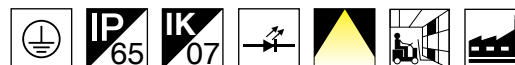

Green
LED | 100 W / 120 W / 150 W
Life 50000 hours | High Efficiency



TECHNICAL DATA

Ordering Code	System Power (W)	Beam Type	Nominal Voltage (V~)	Mains Current (A)	Power Factor	Colour Temp. (CCT)	CRI (Ra)	System Lumens (lm)	Colour of Fixture	System Luminous Efficacy lm/W
SAUCERNEOP100WLED75760DTOLTG	100 W	Narrow Beam	240	0.440	≥0.95	5700 K	≥70	14000	Grey	≥140
SAUCERNEOP100WLED75790DTOLTG	100 W	Wide Beam	240	0.440	≥0.95	5700 K	≥70	14000	Grey	≥140
SAUCERNEOP120WLED75760DTOLTG	120 W	Narrow Beam	240	0.530	≥0.95	5700 K	≥70	15600	Grey	≥130
SAUCERNEOP120WLED75790DTOLTG	120 W	Wide Beam	240	0.530	≥0.95	5700 K	≥70	15600	Grey	≥130
SAUCERNEOP150WLED75760DTOLTG	150 W	Narrow Beam	240	0.660	≥0.95	5700 K	≥80	16000	Grey	≥105
SAUCERNEOP150WLED75790DTOLTG	150 W	Wide Beam	240	0.660	≥0.95	5700 K	≥80	16000	Grey	≥105

IS 10322 (Part 5/Sec 1): 2012



TECHNICAL DRAWING

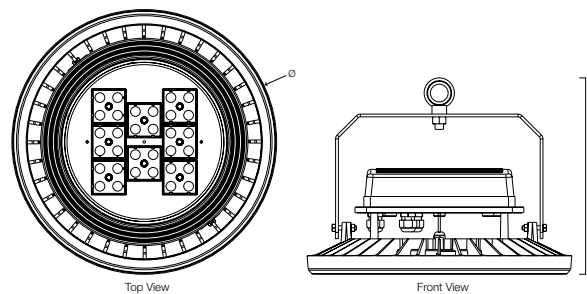

System Power	Ø (mm)	Width w (mm)
100 W / 120 W / 150 W	380	230

All dimensions are in mm
Tolerance: ± 5 mm

PHOTOMETRIC DRAWING

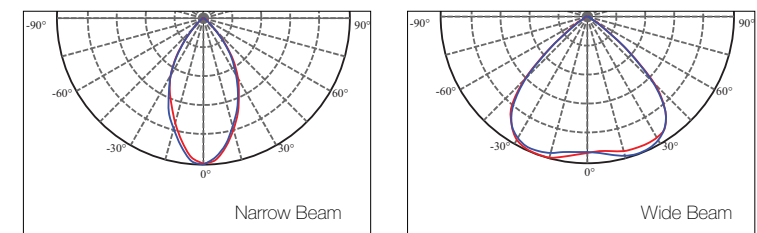

SAUCER NEO

180 W / 200 W

Energy saving, environment friendly & robust Mediumbay / Highbay LED luminaire with high efficacy.



PRODUCT SPECIFICATIONS

Features & Benefits

- Better lumens & longer lamp life
- High efficacy & lower power consumption
- Delivers high brightness & excellent illumination
- No harmful UV & IR radiations
- Environment friendly as it does not contain Mercury
- Instant light with low running temperatures
- Operating temperature: -10° C to +50° C
- Operating voltage range: 140 -270 V
- Average life $L_{70}B_{50}$: 50000 hours

Housing

Aluminum alloy pressure die casted housing for better heat dissipation and aesthetic appeal.

Finish

The fixture is epoxy powder coated with colour munshell grey finish.

Light source

High efficiency long life LEDs with lumen efficacy of >150 lm/W with view angle 120° to ensure better uniformity of light distribution.

Optics

High quality PC lens with optional narrow & wide beam angles for uniform distribution (For Detailed photometric data, please refer LM 79 report & IES file).

Cover

Tempered protective toughened glass, thermal shock and impact resistant fixed to the housing with SS screws.

Electronic driver

Built-In Potted IP67 electronic LED driver with APFC, lower THD, Open Circuit Protection, Over Voltage Protection, Surge Voltage Protection upto 10 kV with integral SPD & other safety test as per IS 15885 Part-2/Sec 13, IEC60598-1, 61547, 61347-2-13, EN 55015.

Mounting

Suspended by means of heavy duty nickel plated, forged eye-bolt provided with the fixture.

Applications

- Cement & steel plants
- Ware houses
- Factories & assembly lines
- Toll plazas

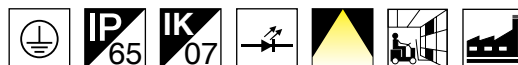

Green
LED | 180 W / 200 W
Life **50000 hours** | HighEfficiency



TECHNICAL DATA

Ordering Code	System Power (W)	Beam Type:	Nominal Voltage (V~)	Mains Current (A)	Power Factor	Colour Temp. (CCT)	CRI (Ra)	System Lumens (lm)	Colour of Fixture	System Luminous Efficacy lm/ W
SAUCERNEOP180WLED75760DTOLTG	180 W	Narrow Beam	240	0.790	≥0.95	5700 K	≥70	24300	Grey	≥135
SAUCERNEOP180WLED75790DTOLTG	180 W	Wide Beam	240	0.790	≥0.95	5700 K	≥70	24300	Grey	≥135
SAUCERNEOP200WLED75760DTOLTG	200 W	Narrow Beam	240	0.880	≥0.95	5700 K	≥70	26000	Grey	≥130
SAUCERNEOP200WLED75790DTOLTG	200 W	Wide Beam	240	0.880	≥0.95	5700 K	≥70	26000	Grey	≥130

IS 10322 (Part 5/Sec.1): 2012



Driver code: LSCELDOX0246 for 180 W & LSCELDOX0272 200 W.

TECHNICAL DRAWING

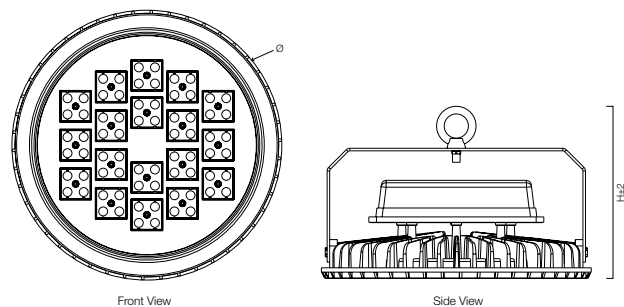

System Power	Ø (mm)	Width w (mm)
180 W / 200 W	424	270

All dimensions are in mm
Tolerance: ± 5 mm

PHOTOMETRIC DRAWING

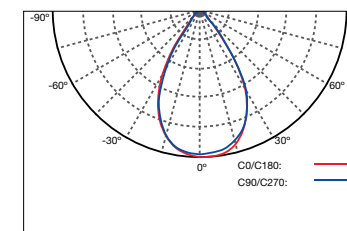

BAYBRITE FLARE

70 W / 80 W

Baybrite flare is a special designed, multi- functional LED luminaire to replace under canopy or Industrial Low- bay.



PRODUCT SPECIFICATIONS

Features & Benefits

- Delivers excellent illumination & comfort in high ceiling areas
- Long life & photobiologically safe LED's
- High performance electronic driver ensures zero maintenance
- No harmful UV & IR radiations
- Environment friendly as it does not contain Mercury
- Instant light with low running temperatures
- Operating temperature:-10° C to +55° C
- Operating voltage range: 140 V - 270 V
- Average life $L_{70}B_{50}$: 50000 hours

Housing

Die-cast aluminium housing (heat sink) for efficient thermal management, sturdiness & excellent corrosion resistant. SS Hardwares,

silicon gasket and M16x1.5 gland is used for cable entry for maintaining ingress protection.

Optics & Cover

UV Stabilized, polycarbonate lens with tempered protective toughened glass 5 mm, thermal shock and impact resistant (IK-07) fixed to the housing with aluminium frame and SS screws (for detailed photometric data , please refer LM 79 report & IES file).

Light source

High efficiency long life LEDs with lumen efficacy of >150 lm/W with view angle 120° to ensure better uniformity of light distribution (For detailed photometric data, please refer LM 79 report & IES file).

Electronic driver

Built-in electronic LED driver with lower THD, Open Circuit Protection, Surge Voltage

Protection & other safety test as per IS 15885 Part-2/Sec 13.

Mounting

Wall or surface mounting using adjustable MS bracket of thickness 5 mm provided with the fixture by 2 elliptical slots of 10x20 mm at center distance of 86 mm.

Applications

- Cement & steel plants
- Ware houses
- Factories & assembly lines
- Toll plazas
- Exterior canopies
- Security and perimeter lighting

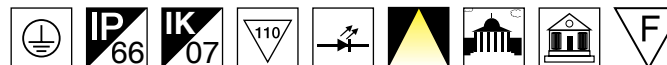

Green
LED | 70 W / 80 W
Life **50000 hours** | HighEfficiency



TECHNICAL DATA

Ordering Code	System Power (W)	Nominal Voltage (V~)	Mains Current (A)	Power Factor	Colour Temp. (CCT)	CRI (Ra)	System Lumens (lm)	Colour of Fixture	System Luminous Efficacy lm/ W
LHEMACP7IC7W070	70 W	240	0.330	≥0.95	5700 K	≥70	8050	Grey	≥115
LHEMACP7IC7W080	80 W	240	0.375	≥0.95	5700 K	≥70	9200	Grey	≥115

IS 10322 (Part 5/Sec.1): 2012



Driver code: LSCELD0X0136 for 70 W, LSCELD0X0236 for 80 W

Assembled Power Coated Frame 595X595X0.8 MM : LSSLOW0313 (to be ordered separately)

TECHNICAL DRAWING

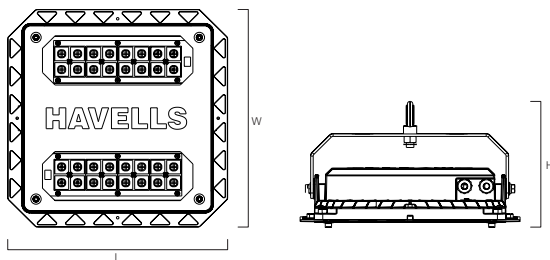

DIMENSION

System Power	Length l (mm)	Width w (mm)	Height h (mm)
70 W	350	350	202
80 W	350	350	202

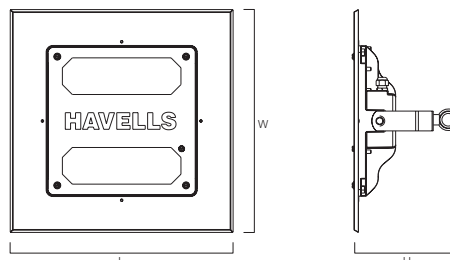

DIMENSION

System Power	Length l (mm)	Width w (mm)	Height h (mm)
70 W	595	595	212
80 W	595	595	212

PHOTOMETRIC DRAWING

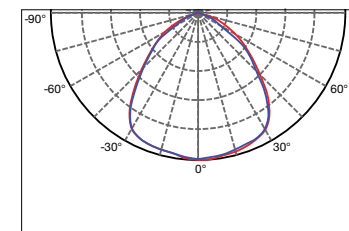

All dimensions are in mm
Tolerance: ± 5 mm

VALOUR HIGHBAY

180 W / 200 W

New generation, Energy Saving, aesthetically designed Highbay LED Luminaire Pressure die-cast Aluminum housing & Non integral IP66 control gear for better thermal management with complete internal wiring. Control gear compartment capable of remote installation for easy maintenance.



PRODUCT SPECIFICATIONS

Features & Benefits

- Delivers excellent illumination & comfort
- Long life & photobiologically safe LED's
- High performance electronic driver ensures zero maintenance
- No harmful UV & IR radiations
- Environment friendly as it does not contain Mercury
- Instant light with low running temperatures
- Operating temperature: -10° C to +50° C
- Operating voltage range: 140 V - 270 V
- Average life $L_{70}B_{50}$: 50000 hours

Housing & Finish

Polyster powder coated die-cast aluminium housing in grey finish with elegantly designed heat sink for efficient thermal management,

sturdiness & excellent corrosion resistant. Cable gland is used for cable entry and provision for loopin-loopout

Light source

High efficiency long life LED module with SMD LED package mounted on MCPCB. Lumen efficacy of LED >140 lm/W and viewing angle of 120° to ensure better uniformity.

Lens & Cover

High quality PC lens with optional narrow & wide beam angles for uniform distribution and Toughened glass fixed to housing. (For Detailed photometric data, please refer LM 79 report & IES file).

Electronic driver & Control Gear Box

Polyster powder coated die-cast aluminium housing in grey finish with elegantly designed control gear Box with Built-In electronic LED

driver with APFC, lower THD, Open Circuit Protection, Over Voltage Protection, Surge Voltage Protection & other safety test as per IS 15885 Part-2/Sec 13,

Mounting

Suspended by means of heavy duty nickel plated, forged eye-bolt provided with the fixture.

Applications

- Cement & steel plants
- Ware houses
- Factories & assembly lines
- Toll plazas

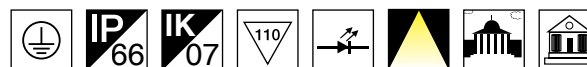

Green
LED | 180 W / 200 W
Life **50000** hours | High Efficiency



TECHNICAL DATA

Ordering Code	System Power (W)	Nominal Voltage (V~)	Mains Current (A)	Power Factor	Colour Temp. (CCT)	CRI (Ra)	System Lumens (lm)	Colour of Fixture	System Luminous Efficacy lm/ W
JETAVALOUR HB180WLED757MODWBLTG	180 W	240	0.780	≥0.95	5700 K	≥70	21600	Grey	≥120
JETAVALOUR HB180WLED757MODNBLTG	180 W	240	0.780	≥0.95	5700 K	≥70	21600	Grey	≥120
JETAVALOUR HB200WLED757MODWBLTG	200 W	240	0.890	≥0.95	5700 K	≥70	24000	Grey	≥120
JETAVALOUR HB200WLED757MODNBLTG	200 W	240	0.890	≥0.95	5700 K	≥70	24000	Grey	≥120

All measurement as per standard test method.
Manufacturing tolerance applicable as per relevant National/International standards.

CONTROL GEAR BOX



(Non Integral Type)

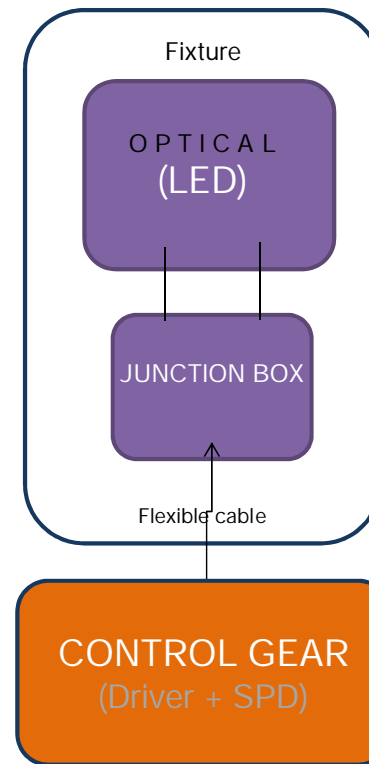

LED LUMINAIRE ARCHITECTURE



Regional & Branch Offices:

NORTH - REGIONAL OFFICE: Corporate Office: QRG Towers, 2D, Sector-126, Expressway, Noida-201304, Tel: 0120-4771000, Fax: 0120-4772000, Delhi: Tel: 011-47676700, 23888200, Fax: 011-47676750, 23888250, Chandigarh: Tel: 0172-4232400-401, Fax: 0172-4232403, Dehradun: Tel: 0135-6670202, Fax: 0135-6670203, Noida / Haryana: Tel: 0120-4771000, Fax: 120-4772000, Ludhiana: Tel: 0161-4676001 / 6024, Fax: 0161-46766007, Jammu: Tel: 0191-2490424, Fax: 0191-2490405, Sri Nagar: Tel / Fax: 0194-2490431, Jaipur: Tel: 0141-3988210, Fax: 0141-2389024, Jodhpur: Tel: 0141-3914645, 3988210, Lucknow: Tel: 0522-2201032, 2200938, Kanpur: Tel: Airtel: 09935533751/52/53, 0512-2690128/129/130, Fax: 0512-2692800

EAST - REGIONAL OFFICE: Kolkata: ICC Tower, 5th Floor, 4 India Exchange Place, Kolkata-700001, Tel: 033-40129851 / 52, Fax: 033-40127339, Bhubaneswar: Tel: 0674-6668101/102/103/104, Fax: 0674-2598107, Guwahati: Tel: 0361-2134521, 2458923, Fax: 0361-2460355, Siliguri: Tel: 0353-2525907, Fax: 0353-3290402 (RIM), Jamshedpur: Tel: 0657-6542492, 09234369436, Patna: Tel: 0612-2207221, 2207222, 2207223, Telefax: 0612-2655518

WEST - REGIONAL OFFICE: Mumbai: 301, Everest House, 3rd Floor, 6, Suren Road, Chakala, Andheri (E). Mumbai - 400 093, Tel: 022-67298600-602 & Fax: 022- 67298603-604, Ahmedabad: Tel: 079-40061111, 40060738-740, Fax: 079-40060741, Indore: Tel: 0731-2572340-41, 4009998 (Airtel), Fax: 0731-2551626, Rajkot: Tel: 0281-2481112, 2921212, Fax: 2481112, Nagpur: Tel: 0712-2224132, 2222692, 2222029, Pune: Tel: 020-64016413 / 14, Raipur: Tel: 0771-4243400 / 01, Telefax: 0771-4243402, Surat: Tel: 09979890137, Telefax: 0261-2350137, Jabalpur: Tel: 0761-4064491

SOUTH - REGIONAL OFFICE: Chennai: Sigapi Achi Building, No. 18 / 3, 6th Floor, Rukmani Lakshminpathy Road, Egmore, Chennai-600008, Tel: 044-42280600, 605, Fax: 044-28524326, Bangalore: Tel: 080-49075000, 9844085913, Fax: 080-25582663, Coimbatore: Telefax: 0422-2305767, 2306199, 2305199, Hyderabad: Tel: 040-27533372, 27533355, 27533632, 66320407/0408/6401/6402, Fax: 040-27533211, Kochi: Tel: 0484-4099000, Fax: 0484-2393170, Vishakapatnam: Tel: 0891-6514339, Fax: 0891-2522547, Vizag: Tel: 0891-6514339, Fax: 0891-25522547, Vijayawada: Tel: 91+9247058847/57, Calicut: 09895855499, Madurai: 099944493242, Trivandrum: 09633817795, Hubli: 09448146028, Trichy: 09944460160

Representative Offices: • Goa • Solapur • Gwalior • Kathmandu • Bhopal



GENERAL CONDITIONS OF BUSINESS

- Prices are in Indian ` (Inclusive of GST)
- All prices are subject to Havells general terms & conditions of business.
- Warranty void for LED fixtures including drivers, if individual points of installations are not provided with proper earthing.
- Orders should be placed in case lot multiples & against the confirmed purchase order only.
- Continuous design improvement is a routine practice at Havells. Data provided may change without any prior intimation. Customers are advised to reconfirm the data or product dimensions before purchase with our local offices.
- This Price List supersedes all our previous Price Lists.
- Prices are subject to change without notice.
- Company reserves the right to issue amendments, which may arise due to any errors in the price list.

HSN Code	Products Included	GST Applicable
9405	LED Fixtures and LED Drivers	12%
9405*	Conventional Fixtures	18%
8504	Ballast (Electronic, HID)/ Ignitors	18%
8543	Solar Street Lights/Mini Mast	5%
7308	Galvanized products	18%
8504*	Rest	18%
8539	Non-LED Lamps	18%

Actual products may vary in colour, design, description and colour combination etc. Although every effort has been made to ensure accuracy in the compilation of the technical detail within this publication. Specifications & performance data are constantly changing. Current details should therefore be checked with Havells Group. Copyright Subsists. Imitation of trade dress, graphics and color scheme of this document is a punishable offence.



HAVELLS

Havells India Ltd.

QRG Towers, 2D, Sector -126, Expressway, Noida - 201 304 (UP), Ph. +91-120-3331000,

E-mail: marketing@havells.com, www.havells.com

Consumer Care No.: 1800 11 0303, 1800 103 1313 (All Connections), 011-4166 0303 (Landline)

Join us on Facebook at www.facebook.com/havells and share your ways to save the planet!

CIN - L31900DL1983PLC016304.

Scan the QR Code
to download
Havells mCatalogue





HAVELLS



CONSUMER LIGHTING

LIST PRICE w.e.f. 1st February, 2023

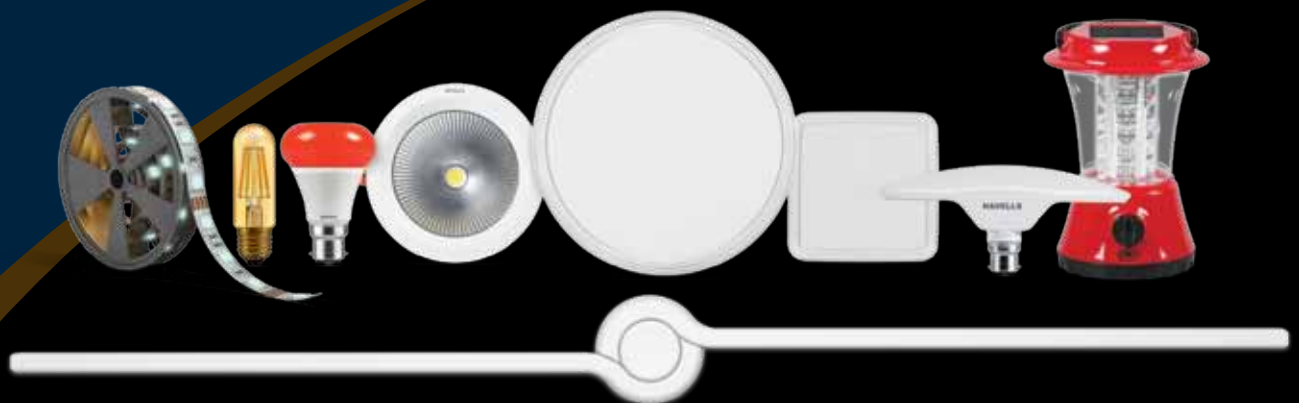



INDEX

CONSUMER LIGHTING



Smart Lighting

4



Glamtubes

8



Consumer LED Luminaires

12



Home Décor Lighting Collection

32



LED Lamps

44



Portable Lighting

52



Smart Lighting

Lighting plays a very important role in our lives, it affects our moods, creates the perfect ambience, gives the mind the power to flourish and creates the feeling of warmth. That's why we say "BETTER LIGHT BETTER LIFE". Add technology to the above and you have the perfect concoction for a happy home, at Havells our range of smart lighting products give full control over your home lighting with just your voice or smartphone.

- Easy connectivity using home Wi-Fi & remote operation
- Smartphone application based (Android and iOS)
- Smart Voice Assistance (Google Home and Alexa) enabled
- Ease of adaptability – Comfort Convenience
- Step towards over-all Home Lighting Automation

GLAMAX SMART LAMP (Tuneable White)

The Havells Tuneable White Smart Bulb is for those who wish to make their home a truly relaxing space. Using a smartphone; you can choose the perfect ambience and set the brightness according to what fits your mood.

Lamp Type	Ordering Code	HSN Code	List Price in ₹ Per Unit	Master Packing (No. of Unit/s)
Glamax LED 9 W TW B22 Smart Lamp	LHLDAMED3A8R009	8539	817.00	24 N
Glamax LED 9 W TW E27 Smart Lamp	LHLDAMHD3A8R009	8539	817.00	24 N



GLAMAX SMART LAMP (RGB)

The Havells RGB Smart Bulb leaves you in awe of technology. A small compact bulb that has the power to change the mood and the setting of your home. You could operate it using your smartphone. Browse through the colour options, alter the brightness and change the ambience according to what fits your mood.

Lamp Type	Ordering Code	HSN Code	List Price in ₹ Per Unit	Master Packing (No. of Unit/s)
Glamax LED 9 W TW+Colors B22 Smart Lamp	LHLDAMED3W8R009	8539	892.00	24 N
Glamax LED 9 W TW+Colors E27 Smart Lamp	LHLDAMHD3W8R009	8539	892.00	24 N



GLAMAX SMART BATTEN (Tuneable White)

Smart Batten is designed meticulously to give you complete control over your home lighting. You could operate the batten using your smartphone. Browse through the colour options, alter the brightness and give your home the perfect ambience that fits your mood.

Lamp Type	Ordering Code	HSN Code	List Price in ₹ Per Unit	Master Packing (No. of Unit/s)
Glamax LED 20 W TW Smart Batten	LHLDAMNDUA8R020	9405	1175.00	6 N

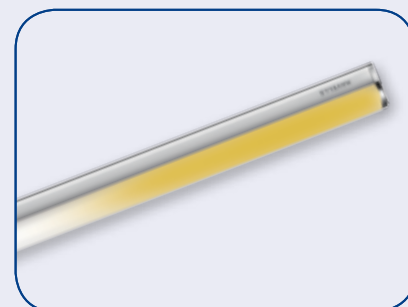

AUROM SMART DOWNLIGHTER (Tuneable White)

Embedded into the ceiling, the downlights blend in with your home while using much lesser space than traditional hanging light fixtures. With even placement, downlights can reach all corners of the room, giving the room a constant glow and keeping the ambience uplifting at all times.

Lamp Type	Ordering Code	HSN Code	List Price in ₹ Per Unit	Master Packing (No. of Unit/s)
Aurom LED 10 W TW Smart Downlighter	LHEBAIPNIZ1W010	9405	1561.00	6 N
Aurom LED 15 W TW Smart Downlighter	LHEBAIPNIZ1W015	9405	1858.00	6 N

Ceiling cutout ø 165 mm, height 36 mm.



GALAKTIC SMART STRIP LIGHT - (RGB with Music Sync)

The Smart Strip light is a combination of both Tunable White LED's and RGB LED's that give a perfect blend of colours for your indirect lighting needs, available in module sizes from 2 metre these strips can be used in various application scenarios to get that perfect mix of functional and mood lighting using your smart phone or voice enable device, it also has a Music Sync feature which enables the light to change colors in sync with the music playing near your smartphone device.

Lamp Type	Ordering Code	HSN Code	List Price in ₹ Per Unit	Master Packing (No. of Unit/s)
Galactic Smart LED Strip 8 W 2 m Roll	LHEHAKP1AIN1W010	9405	2679.00	12 N
Galactic Smart LED Strip 12 W 3 m Roll	LHEHAKP1AIN1W015	9405	3572.00	12 N
Galactic Smart LED Strip Controller Upto 10 m	LSSLNW0240	9405	1407.00	10 N
LED Driver Upto 5 m 24 V 1 A	LSSLNW0241	9405	677.00	10 N

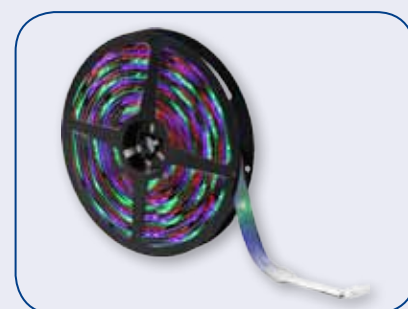

Smart Lighting

AUROM LED SMART SPOTLIGHT (Tuneable White)

Accentuate your décor with low glare focused lighting. Switch from warm to cool, control brightness and schedule your lights as per your convenience. The smart spotlight comes in 2 wattages and 3 driver options wherein higher wattage drivers (15 W & 30 W) can operate upto 2 spotlights together.

Lamp Type	Ordering Code	HSN Code	List Price in ₹ Per Unit	Master Packing (No. of Unit/s)
Aurom Spotlight 7.5 W	LHEBAIP1Z1W7X5	9405	1350.00	6 N
Aurom Spotlight 13 W	LHEBAIP1Z1W013	9405	1850.00	6 N
SMART DRIVER 7.5 W	LSSLNW0254	9405	1800.00	6 N
SMART DRIVER 15 W	LSSLNW0257	9405	2250.00	6 N
SMART DRIVER 30 W	LSSLNW0258	9405	2650.00	6 N
2 m cable for Aurom spot light	LSSLNB0057	9405	170.00	8 N

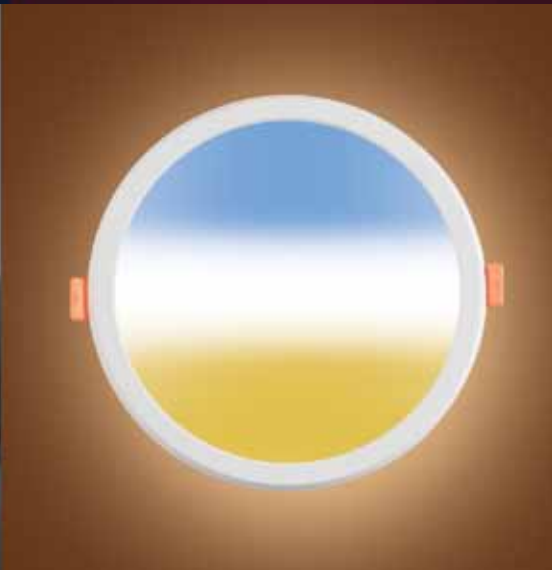





Glamtubes

Havells brings you the stylish range of Glamtubes. Tubes that always just radiate beauty whether they are switched on or off. Get glamour home with the Havells Glamtubes.

These are like pieces of art on your wall, which also illuminate the space they are in. Switch on your style forever with Havells Glamtubes.

VANESSA

Inspired by cosmic rays Vanessa is an infinite source of beauty and brightness.

Lamp Type	Ordering Code	HSN Code	List Price in ₹ Per Unit	Master Packing (No. of Unit/s)
Vanessa Glamtube 20 W 3000 K	LHEWAJPGPV1G020	9405	1330.00	4 N
Vanessa Glamtube 20 W 4000 K	LHEWAJPGPV1F020	9405	1330.00	4 N
Vanessa Glamtube 20 W 6500 K	LHEWAJPGPV1E020	9405	1330.00	4 N



AURORA

Deriving its name from the northern lights that make the sky look magnificent, Aurora just lights up your home with utmost glamour it deserves.

Lamp Type	Ordering Code	HSN Code	List Price in ₹ Per Unit	Master Packing (No. of Unit/s)
Aurora Glamtube 20 W 3000 K	LHEWAJPGPV1J020	9405	1550.00	4 N
Aurora Glamtube 20 W 4000 K	LHEWAJPGPV1I020	9405	1550.00	4 N
Aurora Glamtube 20 W 6500 K	LHEWAJPGPV1H020	9405	1550.00	4 N



STELLA

Stella is drawn from the galaxy. Its light shines bright and looks wonderful.

Lamp Type	Ordering Code	HSN Code	List Price in ₹ Per Unit	Master Packing (No. of Unit/s)
Stella Glamtube 20 W 4000 K	LHEWAJPGPV1D020	9405	1825.00	4 N
Stella Glamtube 20 W 6500 K	LHEWAJPGPV1C020	9405	1825.00	4 N



NICOLAUS

This name means 'dawn', but it also has roots in roman mythology as the goddess of the sunrise.

Lamp Type	Ordering Code	HSN Code	List Price in ₹ Per Unit	Master Packing (No. of Unit/s)
Nicolaus Glamtube 20 W 4000 K	LHEWAJPGPV1A020	9405	1950.00	4 N
Nicolaus Glamtube 20 W 6500 K	LHEWAJPGPV1B020	9405	1950.00	4 N



ATRIA

Like the brightest and the most beautiful Atria star in the southern constellation, this light is bright and beautiful as well.

Lamp Type	Ordering Code	HSN Code	List Price in ₹ Per Unit	Master Packing (No. of Unit/s)
Atria Glamtube 36 W 3000 K	LHEWAJPGPV1D036	9405	2540.00	4 N
Atria Glamtube 36 W 4000 K	LHEWAJPGPV1E036	9405	2540.00	4 N
Atria Glamtube 36 W 6500 K	LHEWAJPGPV1F036	9405	2540.00	4 N



Glamtubes

SUPERNOVA

Inspired by a splendid and bright shooting star Supernova light is very attractive and gleaming.

Lamp Type	Ordering Code	HSN Code	List Price in ₹ Per Unit	Master Packing (No. of Unit/s)
Supernova Glamtube 36 W 3000 K	LHEWAJPGPV1A036	9405	2625.00	4 N
Supernova Glamtube 36 W 4000 K	LHEWAJPGPV1B036	9405	2625.00	4 N
Supernova Glamtube 36 W 6500 K	LHEWAJPGPV1C036	9405	2625.00	4 N





Consumer LED Luminaires

Ultra modern and minimalistic designs with a decorative edge. This range consists of smart edge lit panels, COB spotlights, recess mounted and surface fixtures in timeless finishes, round and square shapes, most appropriate for modern spaces. The range also offers lighting solutions for low ceiling heights.

ASTRAL ROUND

Environmental friendly aesthetically designed, decorative recess mounted 2 W LED spot light for low ceiling height applications.

Lamp Type	Ordering Code	HSN Code	List Price in ₹ Per Unit	Master Packing (No. of Unit/s)
2 W LED 3000 K	LHLDAUSADD8U002	94051100	189.27	40 N
2 W LED 4000 K	LHLDAUSADH8U002	94051100	189.27	40 N
2 W LED 6000 K	LHLDAUSADL8U002	94051100	189.27	40 N
2 W LED RED	LHLDAUSADP8U002	94051100	200.56	40 N
2 W LED GREEN	LHLDAUSADO8U002	94051100	200.56	40 N
2 W LED BLUE	LHLDAUSADS8U002	94051100	200.56	40 N

Ceiling cutout ø 36 mm, height 24 mm.



INNOVA NEO

New Innova Neo swivel spotlight. Aesthetically designed lens based accent light for crisp light output.

Lamp Type	Ordering Code	HSN Code	List Price in ₹ Per Unit	Master Packing (No. of Unit/s)
3 W LED 3000 K	LHEEGBPBIH1W003	94051100	348.87	24 N
3 W LED 4000 K	LHEEGBPDIH1W003	94051100	348.87	24 N
3 W LED 6500 K	LHEEGBPFIH1W003	94051100	348.87	24 N
6 W LED 3000 K	LHEEGBPBIH1W006	94051100	442.09	24 N
6 W LED 4000 K	LHEEGBPDIH1W006	94051100	442.09	24 N
6 W LED 6500 K	LHEEGBPFIH1W006	94051100	442.09	24 N
8 W LED 3000 K	LHEEALPBIH1W008	94051100	629.94	24 N
8 W LED 4000 K	LHEEALPDIH1W008	94051100	629.94	24 N
8 W LED 6500 K	LHEEALPFIH1W008	94051100	629.94	24 N
12 W LED 3000 K	LHEEALPBIH1W012	94051100	840.40	24 N
12 W LED 4000 K	LHEEALPDIH1W012	94051100	840.40	24 N
12 W LED 6500 K	LHEEALPFIH1W012	94051100	840.40	24 N

Ceiling cutout ø 62 mm, height 42 mm for 3 W. Ceiling cutout ø 78 mm, height 42 mm for 6 W.

Ceiling cutout ø 96 mm, height 52 mm for 8 W. Ceiling cutout ø 125 mm, height 54 mm for 12 W.



Consumer LED Luminaires

LED RANGE - RECESS

CRYSTA NEO COB SWIVEL

Recess mounted downlighter with pressure die-cast aluminium heat sink & clear PC as a cover in white powder coated finish with Independent electronic LED driver.

Lamp Type	Ordering Code	HSN Code	List Price in ₹ Per Unit	Master Packing (No. of Unit/s)
3 W LED 3000 K	LHEEAQPBIB1W003	9405	706.00	12 N
3 W LED 4000 K	LHEEAQPDIB1W003	9405	706.00	12 N
3 W LED 6500 K	LHEEAQPFIB1W003	9405	706.00	12 N
6 W LED 3000 K	LHEEAQPBIB1W006	9405	910.00	12 N
6 W LED 4000 K	LHEEAQPDIB1W006	9405	910.00	12 N
6 W LED 6500 K	LHEEAQPFIB1W006	9405	910.00	12 N
9 W LED 3000 K	LHEEAQPBIB1W009	9405	1214.00	12 N
9 W LED 4000 K	LHEEAQPDIB1W009	9405	1214.00	12 N
9 W LED 6500 K	LHEEAQPFIB1W009	9405	1214.00	12 N
12 W LED 3000 K	LHEEAQPBIB1W012	9405	1626.00	12 N
12 W LED 4000 K	LHEEAQPDIB1W012	9405	1626.00	12 N
12 W LED 6500 K	LHEEAQPFIB1W012	9405	1626.00	12 N
18 W LED 3000 K	LHEEAQPBIB1W018	9405	1931.00	6 N
18 W LED 4000 K	LHEEAQPDIB1W018	9405	1931.00	6 N
18 W LED 6500 K	LHEEAQPFIB1W018	9405	1931.00	6 N
24 W LED 3000 K	LHEEAQPBIB1W024	9405	2434.00	6 N
24 W LED 4000 K	LHEEAQPDIB1W024	9405	2434.00	6 N
24 W LED 6500 K	LHEEAQPFIB1W024	9405	2434.00	6 N

Ceiling cutout ø 58 mm, height 43 mm for 3 W. Ceiling cutout ø 72 mm, height 56 mm for 6 W/9 W.

Ceiling cutout ø 85 mm, height 71 mm for 12 W. Ceiling cutout ø 95 mm, height 72 mm for 18 W.

Ceiling cutout ø 125 mm, height 85 mm for 24 W.



OCTANE+ LED PANEL ROUND

Slim, compact, aluminum die cast edge lit panel. Recess mounted round fixture with opal diffuser and separate electronic driver.

Lamp Type	Ordering Code	HSN Code	List Price in ₹ Per Unit	Master Packing (No. of Unit/s)
3 W LED 3000 K	LHEBADP5IZ1W003	94051100	395.48	12 N
3 W LED 4000 K	LHEBADP6IZ1W003	94051100	395.48	12 N
3 W LED 6500 K	LHEBADP7IZ1W003	94051100	395.48	12 N
6 W LED 3000 K	LHEBADP5IZ1W006	94051100	501.41	12 N
6 W LED 4000 K	LHEBADP6IZ1W006	94051100	501.41	12 N
6 W LED 6500 K	LHEBADP7IZ1W006	94051100	501.41	12 N
9 W LED 3000 K	LHEBADP5IZ1W009	94051100	649.72	12 N
9 W LED 4000 K	LHEBADP6IZ1W009	94051100	649.72	12 N
9 W LED 6500 K	LHEBADP7IZ1W009	94051100	649.72	12 N
12 W LED 3000 K	LHEBADP5IZ1W012	94051100	790.96	12 N
12 W LED 4000 K	LHEBADP6IZ1W012	94051100	790.96	12 N
12 W LED 6500 K	LHEBADP7IZ1W012	94051100	790.96	12 N
15 W LED 3000 K	LHEBADP5IZ1W015	94051100	918.08	12 N
15 W LED 4000 K	LHEBADP6IZ1W015	94051100	918.08	12 N
15 W LED 6500 K	LHEBADP7IZ1W015	94051100	918.08	12 N
18 W LED 3000 K	LHEBADP5IZ1W018	94051100	1087.57	12 N
18 W LED 4000 K	LHEBADP6IZ1W018	94051100	1087.57	12 N
18 W LED 6500 K	LHEBADP7IZ1W018	94051100	1087.57	12 N

Ceiling cutout ø 75 mm, height 23 mm ±1 mm for 3 W. Ceiling cutout ø 110 mm, height 23 mm ±1 mm for 6 W.

Ceiling cutout ø 138 mm, height 23 mm ±1 mm for 9 W. Ceiling cutout ø 160 mm, height 23 mm ±1 mm for 12 W.

Ceiling cutout ø 180 mm, height 23 mm ±1 mm for 15 W. Ceiling cutout ø 210 mm, height 23 mm ±1 mm for 18 W.



OCTANE+ LED PANEL SQUARE

Slim, compact, aluminum die cast edge lit panel. Recess mounted square fixture with opal diffuser and separate electronic driver.

Lamp Type	Ordering Code	HSN Code	List Price in ₹ Per Unit	Master Packing (No. of Unit/s)
3 W LED 3000 K	LHEBAEP5IZ1W003	94051100	395.48	12 N
3 W LED 4000 K	LHEBAEP6IZ1W003	94051100	395.48	12 N
3 W LED 6500 K	LHEBAEP7IZ1W003	94051100	395.48	12 N
6 W LED 3000 K	LHEBAEP5IZ1W006	94051100	501.41	12 N
6 W LED 4000 K	LHEBAEP6IZ1W006	94051100	501.41	12 N
6 W LED 6500 K	LHEBAEP7IZ1W006	94051100	501.41	12 N
9 W LED 3000 K	LHEBAEP5IZ1W009	94051100	649.72	12 N
9 W LED 4000 K	LHEBAEP6IZ1W009	94051100	649.72	12 N
9 W LED 6500 K	LHEBAEP7IZ1W009	94051100	649.72	12 N
12 W LED 3000 K	LHEBAEP5IZ1W012	94051100	790.96	12 N
12 W LED 4000 K	LHEBAEP6IZ1W012	94051100	790.96	12 N
12 W LED 6500 K	LHEBAEP7IZ1W012	94051100	790.96	12 N
15 W LED 3000 K	LHEBAEP5IZ1W015	94051100	918.08	12 N
15 W LED 4000 K	LHEBAEP6IZ1W015	94051100	918.08	12 N
15 W LED 6500 K	LHEBAEP7IZ1W015	94051100	918.08	12 N
18 W LED 3000 K	LHEBAEP5IZ1W018	94051100	1087.57	12 N
18 W LED 4000 K	LHEBAEP6IZ1W018	94051100	1087.57	12 N
18 W LED 6500 K	LHEBAEP7IZ1W018	94051100	1087.57	12 N
24 W LED 6500 K	LHEBAEP7IZ1W024	94051100	1553.67	6 N

Ceiling cutout (75x75) mm, height 23 mm ±1 mm for 3 W. Ceiling cutout (110x110) mm, height 23 mm ±1 mm for 6 W.

Ceiling cutout (138x138) mm, height 23 mm ±1 mm for 9 W. Ceiling cutout (160x160) mm, height 23 mm ±1 mm for 12 W.

Ceiling cutout (180x180) mm, height 23 mm ±1 mm for 15 W. Ceiling cutout (210x210) mm, height 23 mm ±1 mm for 18 W.

Ceiling cutout (284x284) mm, height 23 mm ±1 mm for 24 W.



OCTANE LED PANEL ROUND

Slim, compact, aluminum die cast edge lit panel. Recess mounted round fixture with opal diffuser and separate electronic driver.

Lamp Type	Ordering Code	HSN Code	List Price in ₹ Per Unit	Master Packing (No. of Unit/s)
3 W LED 3000 K	LHEBHDP5IZ1W003	94051100	395.48	12 N
3 W LED 4000 K	LHEBHDP6IZ1W003	94051100	395.48	12 N
3 W LED 6500 K	LHEBHDP7IZ1W003	94051100	395.48	12 N
6 W LED 3000 K	LHEBHDP5IZ1W006	94051100	501.41	12 N
6 W LED 4000 K	LHEBHDP6IZ1W006	94051100	501.41	12 N
6 W LED 6500 K	LHEBHDP7IZ1W006	94051100	501.41	12 N
9 W LED 3000 K	LHEBHDP5IZ1W009	94051100	649.72	12 N
9 W LED 4000 K	LHEBHDP6IZ1W009	94051100	649.72	12 N
9 W LED 6500 K	LHEBHDP7IZ1W009	94051100	649.72	12 N
12 W LED 3000 K	LHEBHDP5IZ1W012	94051100	790.96	12 N
12 W LED 4000 K	LHEBHDP6IZ1W012	94051100	790.96	12 N
12 W LED 6500 K	LHEBHDP7IZ1W012	94051100	790.96	12 N
15 W LED 3000 K	LHEBHDP5IZ1W015	94051100	918.08	12 N
15 W LED 4000 K	LHEBHDP6IZ1W015	94051100	918.08	12 N
15 W LED 6500 K	LHEBHDP7IZ1W015	94051100	918.08	12 N
18 W LED 3000 K	LHEBHDP5IZ1W018	94051100	1087.57	12 N
18 W LED 4000 K	LHEBHDP6IZ1W018	94051100	1087.57	12 N
18 W LED 6500 K	LHEBHDP7IZ1W018	94051100	1087.57	12 N

Ceiling cutout ø 75 mm, height 23 mm ±1 mm for 3 W. Ceiling cutout ø 110 mm, height 23 mm ±1 mm for 6 W.

Ceiling cutout ø 138 mm, height 23 mm ±1 mm for 9 W. Ceiling cutout ø 160 mm, height 23 mm ±1 mm for 12 W.

Ceiling cutout ø 180 mm, height 23 mm ±1 mm for 15 W. Ceiling cutout ø 210 mm, height 23 mm ±1 mm for 18 W.



Consumer LED Luminaires

LED RANGE - RECESS

OCTANE LED PANEL SQUARE

Slim, compact, aluminum die cast edge lit panel. Recess mounted square fixture with opal diffuser and separate electronic driver.

Lamp Type	Ordering Code	HSN Code	List Price in ₹ Per Unit	Master Packing (No. of Unit/s)
3 W LED 3000 K	LHEBHEP5IZ1W003	94051100	395.48	12 N
3 W LED 4000 K	LHEBHEP6IZ1W003	94051100	395.48	12 N
3 W LED 6500 K	LHEBHEP7IZ1W003	94051100	395.48	12 N
6 W LED 3000 K	LHEBHEP5IZ1W006	94051100	501.41	12 N
6 W LED 4000 K	LHEBHEP6IZ1W006	94051100	501.41	12 N
6 W LED 6500 K	LHEBHEP7IZ1W006	94051100	501.41	12 N
9 W LED 3000 K	LHEBHEP5IZ1W009	94051100	649.72	12 N
9 W LED 4000 K	LHEBHEP6IZ1W009	94051100	649.72	12 N
9 W LED 6500 K	LHEBHEP7IZ1W009	94051100	649.72	12 N
12 W LED 3000 K	LHEBHEP5IZ1W012	94051100	790.96	12 N
12 W LED 4000 K	LHEBHEP6IZ1W012	94051100	790.96	12 N
12 W LED 6500 K	LHEBHEP7IZ1W012	94051100	790.96	12 N
15 W LED 3000 K	LHEBHEP5IZ1W015	94051100	918.08	12 N
15 W LED 4000 K	LHEBHEP6IZ1W015	94051100	918.08	12 N
15 W LED 6500 K	LHEBHEP7IZ1W015	94051100	918.08	12 N
18 W LED 3000 K	LHEBHEP5IZ1W018	94051100	1087.57	12 N
18 W LED 4000 K	LHEBHEP6IZ1W018	94051100	1087.57	12 N
18 W LED 6500 K	LHEBHEP7IZ1W018	94051100	1087.57	12 N
24 W LED 6500 K	LHEBHEP7IZ1W024	94051100	1553.67	6 N

Ceiling cutout (75x75) mm, height 23 mm ±1 mm for 3 W. Ceiling cutout (110x110) mm, height 23 mm ±1 mm for 6 W.

Ceiling cutout (138x138) mm, height 23 mm ±1 mm for 9 W. Ceiling cutout (160x160) mm, height 23 mm ±1 mm for 12 W.

Ceiling cutout (180x180) mm, height 23 mm ±1 mm for 15 W. Ceiling cutout (210x210) mm, height 23 mm ±1 mm for 18 W.

Ceiling cutout (284x284) mm, height 23 mm ±1 mm for 24 W.



OCTANE LED 2X2 PANEL

Ultra slim recess mounted EdgeLit LED module with high brightness LED package and unique pattern de-glaring PP diffuser and PS LGP de-glaring diffuser sheet for glare free uniform light distribution suitable for armstrong / grid ceiling.

Lamp Type	Ordering Code	HSN Code	List Price in ₹ Per Unit	Master Packing (No. of Unit/s)
36 W LED 3000 K	LHEBAEP5PV1W036	94051100	2169.49	10 N
36 W LED 4000 K	LHEBAEP6PV1W036	94051100	2169.49	10 N
36 W LED 6500 K	LHEBAEP7PV1W036	94051100	2169.49	10 N
40 W LED 3000 K	LHEBAEP5PV1W040	94051100	2303.67	10 N
40 W LED 4000 K	LHEBAEP6PV1W040	94051100	2303.67	10 N
40 W LED 6500 K	LHEBAEP7PV1W040	94051100	2303.67	10 N

Ceiling cutout (583x583) mm, height 9 mm.



OCTANE PLUS LED 2X2 PANEL

Ultra modern recess mounting luminaire with high performance LEDs, suitable for mounting with Armstrong/Grid ceiling.

Lamp Type	Ordering Code	HSN Code	List Price in ₹ Per Unit	Master Packing (No. of Unit/s)
2X2 PANEL 36 W 3000 K	LHEBAEP5IW1W036	94051100	2118.64	4 N
2X2 PANEL 36 W 4000 K	LHEBAEP6IW1W036	94051100	2118.64	4 N
2X2 PANEL 36 W 6500 K	LHEBAEP7IW1W036	94051100	2118.64	4 N

Ceiling cutout (583x583) mm, height 38 mm.



OCTANE GL < 19 UGR PANEL

Slim, compact, UGR<19 compliant, aluminum die cast back lit panel. Recess mounted round fixture with opal diffuser and separate electronic driver.

Lamp Type	Ordering Code	HSN Code	List Price in ₹ Per Unit	Master Packing (No. of Unit/s)
6 W LED 3000 K	LHEBAXP5IZ1W006	94051100	748.59	12 N
6 W LED 4000 K	LHEBAXP6IZ1W006	94051100	748.59	12 N
6 W LED 6500 K	LHEBAXP7IZ1W006	94051100	748.59	12 N
12 W LED 3000 K	LHEBAXP5IZ1W012	94051100	1242.94	12 N
12 W LED 4000 K	LHEBAXP6IZ1W012	94051100	1242.94	12 N
12 W LED 6500 K	LHEBAXP7IZ1W012	94051100	1242.94	12 N
15 W LED 3000 K	LHEBAXP5IZ1W015	94051100	1341.81	12 N
15 W LED 4000 K	LHEBAXP6IZ1W015	94051100	1341.81	12 N
15 W LED 6500 K	LHEBAXP7IZ1W015	94051100	1341.81	12 N
18 W LED 3000 K	LHEBAXP5IZ1W018	94051100	1906.78	12 N
18 W LED 4000 K	LHEBAXP6IZ1W018	94051100	1906.78	12 N
18 W LED 6500 K	LHEBAXP7IZ1W018	94051100	1906.78	12 N

Ceiling cutout Ø 113 mm, height 19 mm for 6 W. Ceiling cutout Ø 162 mm, height 20 mm for 12 W/ 15 W. Ceiling cutout Ø 215 mm, height 21 mm for 18 W.



TRIM SLIM LED PANEL

Slim junction box panel in matt finish, suitable for 5.08 cm (2) junction box installation.

Lamp Type	Ordering Code	HSN Code	List Price in ₹ Per Unit	Master Packing (No. of Unit/s)
3 W LED Slim 3000 K	LHEAATPBIV1W003	94051100	192.09	24 N
3 W LED Slim 4000 K	LHEAATPDIV1W003	94051100	192.09	24 N
3 W LED Slim 6000 K	LHEAATP1IV1W003	94051100	192.09	24 N
3 W LED Slim BLUE	LHEAATPEIV1W003	94051100	211.86	24 N
3 W LED Slim GREEN	LHEAATPCIV1W003	94051100	211.86	24 N
3 W LED Slim RED	LHLDDDBD2C2R003	94051100	211.86	24 N

Ceiling cutout ø 50 mm, height 25 mm.



TRIM LED PANEL ROUND

Aesthetically designed recessed mounted panel in a light weight plastic body available in 3 W, 5 W, 10 W, 15 W and 20 W.

Lamp Type	Ordering Code	HSN Code	List Price in ₹ Per Unit	Master Packing (No. of Unit/s)
3 W LED 3000 K	LHEBAKP5IZ1W003	94051100	183.62	24 N
3 W LED 4000 K	LHEBAKP6IZ1W003	94051100	183.62	24 N
3 W LED 6000 K	LHEBAKP7IZ1W003	94051100	183.62	24 N
3 W LED BLUE	LHEBAKPNIZ1B003	94051100	216.10	24 N
3 W LED GREEN	LHEBAKPNIZ1G003	94051100	216.10	24 N
3 W LED PINK	LHEBAKPNIZ1P003	94051100	216.10	24 N
3 W LED RED	LHEBAKPNIZ1R003	94051100	216.10	24 N
5 W LED 3000 K	LHEBLDP5IN1W005	94051100	346.05	8 N
5 W LED 4000 K	LHEBLDP6IN1W005	94051100	346.05	8 N
5 W LED 6000 K	LHEBLDP7IN1W005	94051100	346.05	8 N
10 W LED 3000 K	LHEBLDP5IN1W010	94051100	423.73	8 N
10 W LED 4000 K	LHEBLDP6IN1W010	94051100	423.73	8 N
10 W LED 6000 K	LHEBLDP7IN1W010	94051100	423.73	8 N
15 W LED 3000 K	LHEBLDP5IN1W015	94051100	586.16	8 N
15 W LED 4000 K	LHEBLDP6IN1W015	94051100	586.16	8 N
15 W LED 6000 K	LHEBLDP7IN1W015	94051100	586.16	8 N
20 W LED 3000 K	LHEBLEP5IN1W020	94051100	1128.53	8 N
20 W LED 4000 K	LHEBLEP6IN1W020	94051100	1128.53	8 N
20 W LED 6000 K	LHEBLEP7IN1W020	94051100	1128.53	8 N

Ceiling cutout ø 42 mm, height 21 mm for 3 W. Ceiling cutout ø 75 mm, height 22 mm for 5 W. Ceiling cutout ø 107 mm, height 22 mm for 10 W. Ceiling cutout ø 140 mm, height 27 mm for 15 W. Ceiling cutout ø 200 mm, height 27 mm for 20 W.



Consumer LED Luminaires

LED RANGE - RECESS

TRIM LED PANEL SQUARE

Aesthetically designed recessed mounted panel in a light weight plastic body available in 5 W, 10 W, 15 W and 20 W.

Lamp Type	Ordering Code	HSN Code	List Price in ₹ Per Unit	Master Packing (No. of Unit/s)
5 W LED 3000 K	LHEBLEP5IN1W005	94051100	346.05	8 N
5 W LED 4000 K	LHEBLEP6IN1W005	94051100	346.05	8 N
5 W LED 6000 K	LHEBLEP7IN1W005	94051100	346.05	8 N
10 W LED 3000 K	LHEBLEP5IN1W010	94051100	423.73	8 N
10 W LED 4000 K	LHEBLEP6IN1W010	94051100	423.73	8 N
10 W LED 6000 K	LHEBLEP7IN1W010	94051100	423.73	8 N
15 W LED 3000 K	LHEBLEP5IN1W015	94051100	586.16	8 N
15 W LED 4000 K	LHEBLEP6IN1W015	94051100	586.16	8 N
15 W LED 6000 K	LHEBLEP7IN1W015	94051100	586.16	8 N
20 W LED 3000 K	LHEBLDP5IN1W020	94051100	1128.53	8 N
20 W LED 4000 K	LHEBLDP6IN1W020	94051100	1128.53	8 N
20 W LED 6000 K	LHEBLDP7IN1W020	94051100	1128.53	8 N

Ceiling cutout (75x75) mm, height 22 mm for 5 W. Ceiling cutout (107x107) mm, height 22 mm for 10 W.

Ceiling cutout (140x140) mm, height 27 mm for 15 W. Ceiling cutout (200x200) mm, height 27 mm for 20 W.

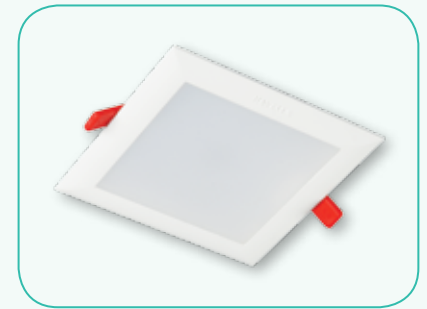

FAZER NEO LED PANEL ROUND

Ultra slim LED panels with inbuilt driver in PC body. Premium aesthetics with stepped ring bezel.

Lamp Type	Ordering Code	HSN Code	List Price in ₹ Per Unit	Master Packing (No. of Unit/s)
3 W LED 3000 K	LHEBMCP5W1W003	94051100	302.26	12 N
3 W LED 4000 K	LHEBMCP6W1W003	94051100	302.26	12 N
3 W LED 6000 K	LHEBMCP7W1W003	94051100	302.26	12 N
6 W LED 3000 K	LHEBMCP5W1W006	94051100	415.25	12 N
6 W LED 4000 K	LHEBMCP6W1W006	94051100	415.25	12 N
6 W LED 6000 K	LHEBMCP7W1W006	94051100	415.25	12 N
10 W LED 3000 K	LHEBMCP5W1W010	94051100	668.08	12 N
10 W LED 4000 K	LHEBMCP6W1W010	94051100	668.08	12 N
10 W LED 6000 K	LHEBMCP7W1W010	94051100	668.08	12 N
15 W LED 3000 K	LHEBMCP5W1W015	94051100	798.02	12 N
15 W LED 4000 K	LHEBMCP6W1W015	94051100	798.02	12 N
15 W LED 6000 K	LHEBMCP7W1W015	94051100	798.02	12 N
20 W LED 3000 K	LHEBMCP5W1W020	94051100	1187.85	12 N
20 W LED 4000 K	LHEBMCP6W1W020	94051100	1187.85	12 N
20 W LED 6000 K	LHEBMCP7W1W020	94051100	1187.85	12 N

Ceiling cutout ø 75 mm, height 25 mm for 3 W. Ceiling cutout ø 100 mm, height 25 mm for 6 W.

Ceiling cutout ø 125 mm, height 25 mm for 10 W. Ceiling cutout ø 150 mm, height 25 mm for 15 W.

Ceiling cutout ø 200 mm, height 25 mm for 20 W.



FAZER NEO LED PANEL SQUARE

Ultra slim LED panels with inbuilt driver in PC body. Premium aesthetics with stepped ring bezel.

Lamp Type	Ordering Code	HSN Code	List Price in ₹ Per Unit	Master Packing (No. of Unit/s)
3 W LED 3000 K	LHEBMDP5IW1W003	94051100	302.26	12 N
3 W LED 4000 K	LHEBMDP6IW1W003	94051100	302.26	12 N
3 W LED 6000 K	LHEBMDP7IW1W003	94051100	302.26	12 N
6 W LED 3000 K	LHEBMDP5IW1W006	94051100	415.25	12 N
6 W LED 4000 K	LHEBMDP6IW1W006	94051100	415.25	12 N
6 W LED 6000 K	LHEBMDP7IW1W006	94051100	415.25	12 N
10 W LED 3000 K	LHEBMDP5IW1W010	94051100	668.08	12 N
10 W LED 4000 K	LHEBMDP6IW1W010	94051100	668.08	12 N
10 W LED 6000 K	LHEBMDP7IW1W010	94051100	668.08	12 N
15 W LED 3000 K	LHEBMDP5IW1W015	94051100	798.02	12 N
15 W LED 4000 K	LHEBMDP6IW1W015	94051100	798.02	12 N
15 W LED 6000 K	LHEBMDP7IW1W015	94051100	798.02	12 N
20 W LED 3000 K	LHEBMDP5IW1W020	94051100	1187.85	12 N
20 W LED 4000 K	LHEBMDP6IW1W020	94051100	1187.85	12 N
20 W LED 6000 K	LHEBMDP7IW1W020	94051100	1187.85	12 N

Ceiling cutout (75x75) mm, height 25 mm for 3 W. Ceiling cutout (100x100) mm, height 25 mm for 6 W.

Ceiling cutout (125x125) mm, height 25 mm for 10 W. Ceiling cutout (150x150) mm, height 25 mm for 15 W.

Ceiling cutout (200x200) mm, height 25 mm for 20 W.



NIMBUS LED PANEL ROUND

Ultra bright compact downlighter in polycarbonate housing with high brightness LED chips, Ideally suited for low ceiling areas to give glare free light, light emitted through rim enhancing the aesthetics of ceiling.

Lamp Type	Ordering Code	HSN Code	List Price in ₹ Per Unit	Master Packing (No. of Unit/s)
5 W LED 3000 K	LHEHAHP5NANB005	94051100	395.48	12 N
5 W LED 4000 K	LHEHAHP5NBNB005	94051100	395.48	12 N
5 W LED 6500 K	LHEHAHP5NBNC005	94051100	395.48	12 N
10 W LED 3000 K	LHEHAAP8NAND010	94051100	670.90	12 N
10 W LED 4000 K	LHEHAAP8NANE010	94051100	670.90	12 N
10 W LED 6500 K	LHEHAAP8NANF010	94051100	670.90	12 N
15 W LED 3000 K	LHEHABP7NAND015	94051100	833.33	12 N
15 W LED 4000 K	LHEHABP7NANE015	94051100	833.33	12 N
15 W LED 6500 K	LHEHABP7NANF015	94051100	833.33	12 N
20 W LED 3000 K	LHLDESABRANW020	94051100	1200.56	6 N
20 W LED 4000 K	LHLDESAERANW020	94051100	1200.56	6 N
20 W LED 6500 K	LHLDESAFRANW020	94051100	1200.56	6 N

Ceiling cutout ø 75 mm, height 43 mm for 5 W. Ceiling cutout ø 107 mm, height 43 mm for 10 W.

Ceiling cutout ø 140 mm, height 43 mm for 15 W. Ceiling cutout ø 200 mm, height 43 mm for 20 W.



Consumer LED Luminaires

LED RANGE - RECESS

NIMBUS LED PANEL SQUARE

Ultra bright compact downlighter in polycarbonate housing with high brightness LED chips, Ideally suited for low ceiling areas to give glare free light, light emitted through rim enhancing the aesthetics of ceiling,

Lamp Type	Ordering Code	HSN Code	List Price in ₹ Per Unit	Master Packing (No. of Unit/s)
5 W LED 3000 K	LHEHAHP5NBND005	94051100	395.48	12 N
5 W LED 4000 K	LHEHAHP5NBNE005	94051100	395.48	12 N
5 W LED 6500 K	LHEHAHP5NBNF005	94051100	395.48	12 N
10 W LED 3000 K	LHEHAAP8NANA010	94051100	670.90	12 N
10 W LED 4000 K	LHEHAAP8NANC010	94051100	670.90	12 N
10 W LED 6500 K	LHEHAAP8NANB010	94051100	670.90	12 N
15 W LED 3000 K	LHEHABP7NANA015	94051100	833.33	12 N
15 W LED 4000 K	LHEHABP7NANB015	94051100	833.33	12 N
15 W LED 6500 K	LHEHABP7NANC015	94051100	833.33	12 N
20 W LED 3000 K	LHLDESAFRANC020	94051100	1200.56	6 N
20 W LED 4000 K	LHLDESAFRAND020	94051100	1200.56	6 N
20 W LED 6500 K	LHLDESAFRANE020	94051100	1200.56	6 N

Ceiling cutout (75x75) mm, height 43 mm for 5 W. Ceiling cutout (107x107) mm, height 43 mm for 10 W.

Ceiling cutout (140x140) mm, height 43 mm for 15 W. Ceiling cutout (200x200) mm, height 43 mm for 20 W.



TRIM PLUS LED PANEL ROUND

Aesthetically designed recessed mounted panel in a light weight plastic body available in 6 W, 9 W, 12 W, 15 W, 18 W and 22 W.

Lamp Type	Ordering Code	HSN Code	List Price in ₹ Per Unit	Master Packing (No. of Unit/s)
6 W LED 3000 K	LHEBFCP5IZ1W006	94051100	427.97	6 N
6 W LED 4000 K	LHEBFCP6IZ1W006	94051100	427.97	6 N
6 W LED 6000 K	LHEBFCP7IZ1W006	94051100	427.97	6 N
9 W LED 3000 K	LHEBFCP5IZ1W009	94051100	679.38	6 N
9 W LED 4000 K	LHEBFCP6IZ1W009	94051100	679.38	6 N
9 W LED 6000 K	LHEBFCP7IZ1W009	94051100	679.38	6 N
12 W LED 3000 K	LHEBFCP5IZ1W012	94051100	781.07	6 N
12 W LED 4000 K	LHEBFCP6IZ1W012	94051100	781.07	6 N
12 W LED 6000 K	LHEBFCP7IZ1W012	94051100	781.07	6 N
15 W LED 3000 K	LHEBFCP5IZ1W015	94051100	819.21	6 N
15 W LED 4000 K	LHEBFCP6IZ1W015	94051100	819.21	6 N
15 W LED 6000 K	LHEBFCP7IZ1W015	94051100	819.21	6 N
18 W LED 3000 K	LHEBFCP5IZ1W018	94051100	1182.20	6 N
18 W LED 4000 K	LHEBFCP6IZ1W018	94051100	1182.20	6 N
18 W LED 6000 K	LHEBFCP7IZ1W018	94051100	1182.20	6 N
22 W LED 3000 K	LHEBFCP5IZ1W022	94051100	1439.27	6 N
22 W LED 4000 K	LHEBFCP6IZ1W022	94051100	1439.27	6 N
22 W LED 6000 K	LHEBFCP7IZ1W022	94051100	1439.27	6 N

Ceiling cutout ø 95 mm, height 37 mm for 6 W. Ceiling cutout ø 95 mm, height 37 mm for 9 W.

Ceiling cutout ø 145 mm, height 37 mm for 12 W. Ceiling cutout ø 145 mm, height 37 mm for 15 W.

Ceiling cutout ø 195 mm, height 37 mm for 18 W. Ceiling cutout ø 195 mm, height 37 mm for 22 W.



TRIM PLUS LED PANEL SQUARE

Aesthetically designed recessed mounted panel in a light weight plastic body available in 6 W, 9 W, 12 W, 15 W, 18 W and 22 W.

Lamp Type	Ordering Code	HSN Code	List Price in ₹ Per Unit	Master Packing (No. of Unit/s)
6 W LED 3000 K	LHEBGAP5IZ1W006	94051100	427.97	6 N
6 W LED 4000 K	LHEBGAP6IZ1W006	94051100	427.97	6 N
6 W LED 6000 K	LHEBGAP7IZ1W006	94051100	427.97	6 N
9 W LED 3000 K	LHEBGAP5IZ1W009	94051100	679.38	6 N
9 W LED 4000 K	LHEBGAP6IZ1W009	94051100	679.38	6 N
9 W LED 6000 K	LHEBGAP7IZ1W009	94051100	679.38	6 N
12 W LED 3000 K	LHEBGAP5IZ1W012	94051100	781.07	6 N
12 W LED 4000 K	LHEBGAP6IZ1W012	94051100	781.07	6 N
12 W LED 6000 K	LHEBGAP7IZ1W012	94051100	781.07	6 N
15 W LED 3000 K	LHEBGAP5IZ1W015	94051100	819.21	6 N
15 W LED 4000 K	LHEBGAP6IZ1W015	94051100	819.21	6 N
15 W LED 6000 K	LHEBGAP7IZ1W015	94051100	819.21	6 N
18 W LED 3000 K	LHEBGAP5IZ1W018	94051100	1182.20	6 N
18 W LED 4000 K	LHEBGAP6IZ1W018	94051100	1182.20	6 N
18 W LED 6000 K	LHEBGAP7IZ1W018	94051100	1182.20	6 N
22 W LED 3000 K	LHEBGAP5IZ1W022	94051100	1439.27	6 N
22 W LED 4000 K	LHEBGAP6IZ1W022	94051100	1439.27	6 N
22 W LED 6000 K	LHEBGAP7IZ1W022	94051100	1439.27	6 N

Ceiling cutout (95x95) mm, height 37 mm for 6 W. Ceiling cutout (95x95) mm, height 37 mm for 9 W.

Ceiling cutout (145x145) mm, height 37 mm for 12 W. Ceiling cutout (145x145) mm, height 37 mm for 15 W.

Ceiling cutout (195x195) mm, height 37 mm for 18 W. Ceiling cutout (195x195) mm, height 37 mm for 22 W.

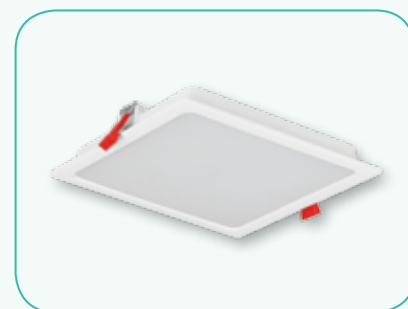

TRIM PLUS ROUND SURFACE ACCESSORIES

Surface accessories module for Trim Plus LED Panel.

Lamp Type	Ordering Code	HSN Code	List Price in ₹ Per Unit	Master Packing (No. of Unit/s)
Surface Module Trim Plus 6 W, 9 W	LSSLNW0129	94059200	179.38	6 N
Surface Module Trim Plus 12 W, 15 W	LSSLNW0131	94059200	265.54	6 N
Surface Module Trim Plus 18 W, 22 W	LSSLNW0133	94059200	317.80	6 N



TRIM PLUS SQUARE SURFACE ACCESSORIES

Surface accessories module for Trim Plus LED Panel.

Lamp Type	Ordering Code	HSN Code	List Price in ₹ Per Unit	Master Packing (No. of Unit/s)
Surface Module Trim Plus 6 W, 9 W	LSSLNW0130	94059200	179.38	6 N
Surface Module Trim Plus 12 W, 15 W	LSSLNW0132	94059200	265.54	6 N
Surface Module Trim Plus 18 W, 22 W	LSSLNW0134	94059200	317.80	6 N

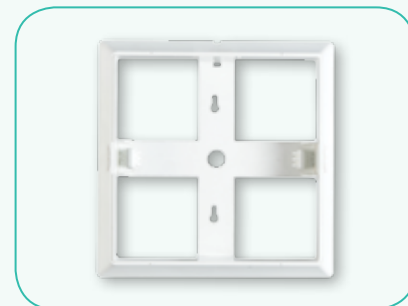

Consumer LED Luminaires

LED RANGE - RECESS / SURFACE

TRIM CLIPON LED PANEL ROUND

Unique slimmest recess com surface panel, solution to provide variable cutout size for installation in recess.

Lamp Type	Ordering Code	HSN Code	List Price in ₹ Per Unit	Master Packing (No. of Unit/s)
6 W LED 3000 K	LHEAABP5IL1W006	94051100	844.63	12 N
6 W LED 4000 K	LHEAABP6IL1W006	94051100	844.63	12 N
6 W LED 6500 K	LHEAABP7IL1W006	94051100	844.63	12 N
12 W LED 3000 K	LHEAABP5IL1W012	94051100	1206.21	12 N
12 W LED 4000 K	LHEAABP6IL1W012	94051100	1206.21	12 N
12 W LED 6500 K	LHEAABP7IL1W012	94051100	1206.21	12 N
18 W LED 3000 K	LHEAABP5IL1W018	94051100	1720.34	12 N
18 W LED 4000 K	LHEAABP6IL1W018	94051100	1720.34	12 N
18 W LED 6500 K	LHEAABP7IL1W018	94051100	1720.34	12 N
24 W LED 3000 K	LHEAABP5IL1W024	94051100	2285.31	12 N
24 W LED 4000 K	LHEAABP6IL1W024	94051100	2285.31	12 N
24 W LED 6500 K	LHEAABP7IL1W024	94051100	2285.31	12 N

Ceiling cutout ø (55-90) mm, height 14 mm for 6 W. Ceiling cutout ø (60-135) mm, height 14 mm for 12 W.
Ceiling cutout ø (60-185) mm, height 14 mm for 18 W. Ceiling cutout ø (60-260) mm, height 14 mm for 24 W.



TRIM CLIPON LED PANEL SQUARE

Unique slimmest recess com surface panel, solution to provide variable cutout size for installation in recess.

Lamp Type	Ordering Code	HSN Code	List Price in ₹ Per Unit	Master Packing (No. of Unit/s)
6 W LED 3000 K	LHEAABP5IN1W006	94051100	844.63	12 N
6 W LED 4000 K	LHEAABP6IN1W006	94051100	844.63	12 N
6 W LED 6500 K	LHEAABP7IN1W006	94051100	844.63	12 N
12 W LED 3000 K	LHEAABP5IN1W012	94051100	1206.21	12 N
12 W LED 4000 K	LHEAABP6IN1W012	94051100	1206.21	12 N
12 W LED 6500 K	LHEAABP7IN1W012	94051100	1206.21	12 N
18 W LED 3000 K	LHEAABP5IN1W018	94051100	1720.34	12 N
18 W LED 4000 K	LHEAABP6IN1W018	94051100	1720.34	12 N
18 W LED 6500 K	LHEAABP7IN1W018	94051100	1720.34	12 N
24 W LED 3000 K	LHEAABP5IN1W024	94051100	2285.31	12 N
24 W LED 4000 K	LHEAABP6IN1W024	94051100	2285.31	12 N
24 W LED 6500 K	LHEAABP7IN1W024	94051100	2285.31	12 N

Ceiling cutout (55-90) mm, height 14 mm for 6 W. Ceiling cutout (60-135) mm, height 14 mm for 12 W.
Ceiling cutout (60-185) mm, height 14 mm for 18 W. Ceiling cutout (60-260) mm, height 14 mm for 24 W.



TRIM COSMO SURFACE ROUND

Slim surface mounted LED panel with premium diffuser to ensure glare free & even light distribution.

Lamp Type	Ordering Code	HSN Code	List Price in ₹ Per Unit	Master Packing (No. of Unit/s)
6 W LED 3000 K	LHEAAHP5IL1W006	94051100	646.89	24 N
6 W LED 4000 K	LHEAAHP6IL1W006	94051100	646.89	24 N
6 W LED 6500 K	LHEAAHP7IL1W006	94051100	646.89	24 N
12 W LED 3000 K	LHEAAHP5IL1W012	94051100	906.78	24 N
12 W LED 4000 K	LHEAAHP6IL1W012	94051100	906.78	24 N
12 W LED 6500 K	LHEAAHP7IL1W012	94051100	906.78	24 N
18 W LED 3000K	LHEAAHP5IL1W018	94051100	1358.76	12 N
18 W LED 4000 K	LHEAAHP6IL1W018	94051100	1358.76	12 N
18 W LED 6500 K	LHEAAHP7IL1W018	94051100	1358.76	12 N
24 W LED 3000 K	LHEAAHP5IL1W024	94051100	2038.14	12 N
24 W LED 4000 K	LHEAAHP6IL1W024	94051100	2038.14	12 N
24 W LED 6500 K	LHEAAHP7IL1W024	94051100	2038.14	12 N

Dimension: ø 90 mm, Height: 27 mm for 6 W, ø 120 mm, Height: 27 for 12 W, ø 156 mm, Height: 27 mm for 18 W, ø 190 mm, Height: 27 mm for 24 W.



TRIM COSMO SURFACE SQUARE

Slim surface mounted LED panel with premium diffuser to ensure glare free & even light distribution.

Lamp Type	Ordering Code	HSN Code	List Price in ₹ Per Unit	Master Packing (No. of Unit/s)
6 W LED 3000 K	LHEAAKP5IL1W006	94051100	646.89	24 N
6 W LED 4000 K	LHEAAKP6IL1W006	94051100	646.89	24 N
6 W LED 6500 K	LHEAAKP7IL1W006	94051100	646.89	24 N
12 W LED 3000 K	LHEAAKP5IL1W012	94051100	906.78	24 N
12 W LED 4000 K	LHEAAKP6IL1W012	94051100	906.78	24 N
12 W LED 6500 K	LHEAAKP7IL1W012	94051100	906.78	24 N
18 W LED 3000K	LHEAAKP5IL1W018	94051100	1358.76	12 N
18 W LED 4000 K	LHEAAKP6IL1W018	94051100	1358.76	12 N
18 W LED 6500 K	LHEAAKP7IL1W018	94051100	1358.76	12 N
24 W LED 3000 K	LHEAAKP5IL1W024	94051100	2038.14	12 N
24 W LED 4000 K	LHEAAKP6IL1W024	94051100	2038.14	12 N
24 W LED 6500 K	LHEAAKP7IL1W024	94051100	2038.14	12 N

Dimension: Length: 90 mm, Width: 90 mm & Height: 27 mm for 6 W, Length: 120 mm, Width: 120 mm & Height: 28 mm for 12 W, Length: 155 mm, Width: 155 mm & Height: 27 mm for 18 W, Length: 190 mm, Width: 190 mm & Height: 28 mm for 24 W.

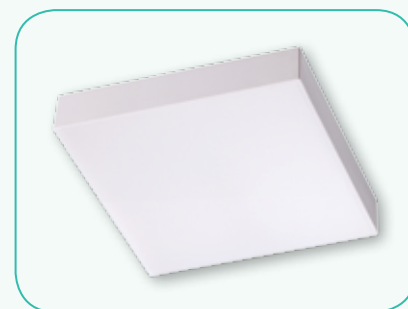

LUMENO LED DOWNLIGHTERS ROUND

Aesthetically designed, decorative recess mounted 3 W, 5 W, 8 W and 12 W LED (Round) spot light for low ceiling height applications.

Lamp Type	Ordering Code	HSN Code	List Price in ₹ Per Unit	Master Packing (No. of Unit/s)
LED LIGHT Lumeno 5 W Round 3000 K	LHEEBPP5IN1W005	94051100	268.36	12 N
LED LIGHT Lumeno 5 W Round 6500 K	LHEEBPP7IN1W005	94051100	268.36	12 N
LED LIGHT Lumeno 8 W Round 6500 K Concealed Box	LHEAALP7TV1W008	94051100	353.11	12 N
LED LIGHT Lumeno 10 W Round 6500 K Concealed Box	LHEXBON5AN5A010	94051100	409.60	12 N
LED LIGHT Lumeno 10 W Round 3000 K	LHEXBON5AN5C010	94051100	409.60	12 N
LED LIGHT Lumeno 8 W Round 3000 K	LHEEBPP5IL1W008	94051100	353.11	12 N
LED LIGHT Lumeno 8 W Round 6500 K	LHEEBPP7IL1W008	94051100	353.11	12 N
LED LIGHT Lumeno 6 W IP65 Round 3000 K	LHEEBPP5IL6W006	94051100	500.00	12 N
LED LIGHT Lumeno 6 W IP65 Round 4000 K	LHEEBPP6IL6W006	94051100	500.00	12 N
LED LIGHT Lumeno 6 W IP65 Round 6000 K	LHEEBPP7IL6W006	94051100	500.00	12 N

Ceiling cutout ø 90 mm, height 38 mm for 3 W Round. Ceiling cutout ø 70 mm, height 46 mm for 6 W Round. Ceiling cutout ø 110 mm, height 46 mm for 8 W Round. Ceiling cutout ø 140 mm, height 46 mm for 12 W Round.



Consumer LED Luminaires

LED RANGE - RECESS DOWNLIGHTERS

LUMENO LED COLOURED DOWNLIGHTERS ROUND

Aesthetically designed, decorative recess mounted 5 W LED spot light for low ceiling height applications.

Lamp Type	Ordering Code	HSN Code	List Price in ₹ Per Unit	Master Packing (No. of Unit/s)
5 W Round Green	LHLDEBNBMO5P005	94051100	282.49	12 N
5 W Round Red	LHLDEBNBMP5P005	94051100	282.49	12 N
5 W Round Blue	LHLDEBNBMS5P005	94051100	282.49	12 N
5 W Round Pink	LHLDEBNBMY5P005	94051100	282.49	12 N

Ceiling cutout ø 95 mm, height 46 mm for 5 W Round.



JOY NEO DOWNLIGHTER 3 W

3 W junction box downlighter suitable for installation in 5.08 cm (2) deep junction box.

Lamp Type	Ordering Code	HSN Code	List Price in ₹ Per Unit	Master Packing (No. of Unit/s)
JOY NEO LED 3 W JB 3000 K	LHEBALP5IZ1W003	94051100	187.85	24 N
JOY NEO LED 3 W JB 6500 K	LHEBALP7IZ1W003	94051100	187.85	24 N
JOY NEO LED 3 W JB BLUE	LHEBALPEIZ1W003	94051100	220.34	24 N
JOY NEO LED 3 W JB GREEN	LHEBALPCIZ1W003	94051100	220.34	24 N
JOY NEO LED 3 W JB RED	LHEBALPAIZ1W003	94051100	220.34	24 N

Ceiling cutout ø 40 mm, height 35±1 mm.



JOY NEO DOWNLIGHTER 7 W

7 W downlighter suitable for installation in 7.62 cm (3) concealed box.

Lamp Type	Ordering Code	HSN Code	List Price in ₹ Per Unit	Master Packing (No. of Unit/s)
JOY NEO LED 7 W JB 3000 K	LHEBALP5IZ1W007	94051100	364.41	24 N
JOY NEO LED 7 W JB 6500 K	LHEBALP7IZ1W007	94051100	364.41	24 N
JOY NEO LED 7 W JB BLUE	LHEBALPEIZ1W007	94051100	379.94	24 N
JOY NEO LED 7 W JB GREEN	LHEBALPCIZ1W007	94051100	379.94	24 N
JOY NEO LED 7 W JB RED	LHEBALPAIZ1W007	94051100	379.94	24 N

Ceiling cutout ø 68 mm, height 46±1 mm.



JOY NEO DOWNLIGHTER 12 W

12 W downlighter suitable for installation in 5.08 cm (2) deep junction box, slim junction box and 7.62 cm (3) concealed box.

Lamp Type	Ordering Code	HSN Code	List Price in ₹ Per Unit	Master Packing (No. of Unit/s)
JOY NEO LED JB 12 W 3000 K	LHEBALP5IZ1W012	94051100	598.87	24 N
JOY NEO LED JB 12 W 6500 K	LHEBALP7IZ1W012	94051100	598.87	24 N
JOY NEO LED JB 12 W DUO 6500 K+3000 K	LHEBAMP7IZ1W012	94051100	683.62	24 N
JOY NEO LED JB 12 W DUO 6500 K+BLUE	LHEBAMPEIZ1W012	94051100	683.62	24 N

Ceiling cutout ø 46 mm, height 56±1 mm.



Consumer LED Luminaires

LED RANGE - RECESS DOWNLIGHTERS

JOY NEO SLIM DOWNLIGHTER 7 W

7 W sim downlighter suitable for installation in 5.08 cm (2) deep junction box & slim junction box.

Lamp Type	Ordering Code	HSN Code	List Price in ₹ Per Unit	Master Packing (No. of Unit/s)
JOY NEO LED SLIM JB 7 W 3000 K	LHEBAMP5IZ1W007	94051100	347.46	24 N
JOY NEO LED SLIM JB 7 W 6500 K	LHEBAMP7IZ1W007	94051100	347.46	24 N
JOY NEO LED SLIM JB 7 W DUO 6500 K+3000 K	LHEBANP7IZ1W007	94051100	430.79	24 N
JOY NEO LED SLIM JB 7 W DUO 6500 K+BLUE	LHEBANPEIZ1W007	94051100	430.79	24 N

Ceiling cutout ø 46 mm, height 45±1 mm.



JOY NEO SURFACE DOWNLIGHTER 5 W

5 W striker suitable for installation in 5.08 cm (2) deep junction box, slim Junction box, cabinets and surface applications.

Lamp Type	Ordering Code	HSN Code	List Price in ₹ Per Unit	Master Packing (No. of Unit/s)
JOY NEO LED STRIKER 5 W 3000 K	LHEAATP5IL1W005	94051100	314.97	24 N
JOY NEO LED STRIKER 5 W 6500 K	LHEAATP7IL1W005	94051100	314.97	24 N



JOY NEO SURFACE DOWNLIGHTER 7 W

7 W ceiling dome suitable for installation in 5.08 cm (2) deep junction box, slim junction box, cabinets and surface applications.

Lamp Type	Ordering Code	HSN Code	List Price in ₹ Per Unit	Master Packing (No. of Unit/s)
JOY NEO LED CEILING DOME 7 W 6500 K	LHEAATP7IL1W007	94051100	483.05	24 N



OCTANE LED PANEL DRIVERS

LED edgelit panel drivers with universal connector for easy installations.

Lamp Type	Ordering Code	HSN Code	List Price in ₹ Per Unit	Master Packing (No. of Unit/s)
Panel Driver 3 W	LSSLNW0167	85044090	120.00	24 N
Panel Driver 4 W / 8 W	LSSLNW0168	85044090	180.00	24 N
Panel Driver 9 W / 12 W	LSSLNW0169	85044090	230.00	24 N
Panel Driver 15 W / 18 W	LSSLNW0170	85044090	280.00	24 N
Panel Driver 24 W	LSSLNW0171	85044090	300.00	24 N



Consumer LED Luminaires

LED RANGE - BATTEN

E-LITE LED PRIDE PLUS/NXT

Decorative ultra slim round profile LED lighting fixture with extruded polycarbonate, environmental friendly, energy efficient ready to use pack.

Lamp Type	Ordering Code	HSN Code	List Price in ₹ Per Unit	Master Packing (No. of Unit/s)
5 W LED 6500 K	LHEXBLP7IN1W005	9405	255.40	20 N
9 W LED 6500 K	LHEXBLP7IN1W009	9405	259.20	20 N
18 W LED 3000 K	LHEXBLP5PN1W018	9405	266.90	20 N
18 W LED 6500 K	LHEXBLP7PN1W018	9405	266.90	20 N
20 W LED 6500 K	LHEXBLP7PN1W020	9405	272.60	20 N
20 W LED 6500 K NXT	LHEXAPP7UN1W020	9405	263.00	20 N
20 W LED 6500 K NXT	LHEXAPP7UN1W020	9405	263.00	20 N



E-LITE LED PRIDE PLUS NEO

Decorative ultra slim square profile LED lighting fixture with extruded polycarbonate, environmental friendly, energy efficient ready to use pack.

Lamp Type	Ordering Code	HSN Code	List Price in ₹ Per Unit	Master Packing (No. of Unit/s)
5 W LED 6500 K	LHEXBTP7IN1W005	9405	255.40	20 N
10 W LED 3000 K	LHEXACP5IN1W010	9405	259.20	20 N
10 W LED 6500 K	LHEXACP7IN1W010	9405	259.20	20 N



LED PRIDE ESSENTIAL

Decorative ultra slim square profile LED lighting fixture with extruded polycarbonate, environmental friendly, energy efficient ready to use pack.

Lamp Type	Ordering Code	HSN Code	List Price in ₹ Per Unit	Master Packing (No. of Unit/s)
18W LED 6500 K	LHEXAWP7IN1W018	9405	254.00	20 N
20 W LED 3000 K	LHEXAWP5IN1W020	9405	263.00	20 N
20 W LED 4000 K	LHEXAWP6IN1W020	9405	263.00	20 N
20 W LED 6500 K	LHEXAWP7IN1W020	9405	263.00	20 N



AUSTRA MIRROR LIGHT 20 W

The smart, contemporary design of mirror light - Austra which makes it a perfect fit for any kind of architecture. The design is a harmonious blend of curves and angles.

Lamp Type	Ordering Code	HSN Code	List Price in ₹ Per Unit	Master Packing (No. of Unit/s)
20 W LED 3000 K	LHLDESAARANA020	9405	700.00	20 N
20 W LED 4000 K	LHLDESAARANB020	9405	700.00	20 N
20 W LED 6500 K	LHLDESAARANC020	9405	700.00	20 N



COMFY VIZON

Premium 20 W LED batten with 'Eye Soft' technology & glarefree diffuser for perfect application in modern homes.

Lamp Type	Ordering Code	HSN Code	List Price in ₹ Per Unit	Master Packing (No. of Unit/s)
20 W LED 6500 K	LHEXARP7SN1W020	9405	349.40	20 N



PRIDE PLUS MAGIC-I

Innovative 20 W LED batten that works automatically through motion detection within 5 metre range & turn off within 30 seconds of non movement.

Lamp Type	Ordering Code	HSN Code	List Price in ₹ Per Unit	Master Packing (No. of Unit/s)
20 W LED 6500 K	LHEXARP7UN1W020	9405	647.00	20 N



PRIDE PLUS INVERTER BATTEN

Inverter LED batten with square profile and polycarbonate channel. Lithium Ion battery with charging time 8hours-10 hours and back up time upto 4 hours.

Lamp Type	Ordering Code	HSN Code	List Price in ₹ Per Unit	Master Packing (No. of Unit/s)
20 W LED 6500 K	LHEXACP7FN1W020	9405	795.80	20 N



HIGH WATTAGE (ALUMINIUM BATTENS)

Decorative ultra slim aluminium LED lighting fixture with high lumen output, environmental friendly, energy efficient ready to use pack.

Lamp Type	Ordering Code	HSN Code	List Price in ₹ Per Unit	Master Packing (No. of Unit/s)
32 W LED 6500 K	LHEXACP7IN1J032	9405	659.00	20 N
40 W LED 6500 K	LHEXACP7IN1J040	9405	851.00	20 N



HIGH WATTAGE (PC BATTENS)

Decorative ultra slim polycarbonate LED lighting fixture with high lumen output, environmental friendly, energy efficient ready to use pack.

Lamp Type	Ordering Code	HSN Code	List Price in ₹ Per Unit	Master Packing (No. of Unit/s)
22 W LED 6500 K	LHEXBLP7PN1W022	9405	323.50	20 N
25 W LED 6500 K	LHEXACP7IN1W025	9405	535.70	20 N
25 W 6500 K Essential	LHEXAWP7IN1W025	9405	360.00	20 N
30 W 6500 K Essential	LHEXAWP7IN1W030	9405	550.00	20 N



MAXOLED BATTEN - for T8 LED Retro Lamp (G13)

Ultra bright, glass shell, glare free, wide angle, single side connection retrofit LED tube with G13 lamp holders.

Lamp Type	Ordering Code	HSN Code	List Price in ₹ Per Unit	Master Packing (No. of Unit/s)
Suitable for Maxoled LED Tube	LHFXCENNTN1W020	9405	135.00	20 N





CENTURA NEO

Flood Lights with best in class design & Robust heat sink along with class leading IP, IK & Surge protections for long lasting performance.

Lamp Type	Ordering Code	HSN Code	List Price in ₹ Per Unit	Master Packing (No. of Unit/s)
30 W LED 6500 K	LHEECNP7PB6J030	9405	1685.00	6 N
50 W LED 6500 K	LHEECNP7PB6J050	9405	2090.00	6 N
100 W LED 6500 K	LHEECNP7PB7J100	9405	3770.00	4 N



SUPERB STREET LIGHT

Street Lights with best in class design & Robust heat sink along with class leading IP, IK & Surge protections for long lasting performance.

Lamp Type	Ordering Code	HSN Code	List Price in ₹ Per Unit	Master Packing (No. of Unit/s)
20 W LED 6500 K	LHEXAYP7PN6K020	9405	1590.00	6 N
30 W LED 6500 K	LHEXAYP7PN6K030	9405	2190.00	6 N
50 W LED 6500 K	LHEXAYP7PN6K050	9405	2815.00	4 N



FLEXION LED AC STRIP

High brightness IP65 LED strips with uniformity of light required for perfect outdoor application.

Lamp Type	Ordering Code	HSN Code	List Price in ₹ Per Unit	Master Packing (No. of Unit/s)
Flexion LED AC Rope 120 LED/M 3000 K IP65	LHEHCPP5TN6F325	9405	8035.00	1 N
Flexion LED AC Rope 120 LED/M 6500 K IP65	LHEHCPP7TN6F325	9405	8035.00	1 N
Flexion LED AC Rope 120 LED/M BLUE IP65	LHEHCPPFTN6F325	9405	8035.00	1 N
Flexion LED AC Rope 120 LED/M RED IP65	LHEHCPPGTN6F325	9405	8035.00	1 N
Flexion LED AC Rope 120 LED/M PINK IP65	LHEHCPPKTN6F325	9405	8035.00	1 N
Flexion LED AC Rope 120 LED/M GREEN IP65	LHEHCPPHTN6F325	9405	8035.00	1 N
Flexion LED AC Rope 96 LED/M 3000 K IP65	LHEHCPP5TA6J325	9405	7255.00	1 N
Flexion LED AC Rope 96 LED/M 6500 K IP65	LHEHCPP7TA6J325	9405	7255.00	1 N
Flexion LED AC Rope 96 LED/M BLUE IP65	LHEHCPPFTA6J325	9405	7255.00	1 N
Flexion LED AC Rope 96 LED/M GREEN IP65	LHEHCPPHTA6J325	9405	7255.00	1 N
Flexion LED AC Rope 96 LED/M PINK IP65	LHEHCPPKTA6J325	9405	7255.00	1 N
Flexion LED AC Rope 96 LED/M RED IP65	LHEHCPPGTA6J325	9405	7255.00	1 N
AC ROPE 120 & 96 LED/M Light Accessories	LSSLNW0200	9405	233.00	40 N
Flexion LED AC Rope Strip RGB IP65	LHEHCPP1ATA6F075	9405	5700.00	4 N
AC Rope RGB Light Accessories	LSSLNX0956	9405	1200.00	5 N
Flexion LED AC Rope 60 LED/M 6500K IP65	LHEHCPP7TA6J300	9405	2600.00	1 N
Flexion LED AC Rope 60 LED/M 3000K IP65	LHEHCPP5TA6J300	9405	2600.00	1 N
Flexion LED AC Rope 60 LED/M 4000K IP65	LHEHCPP6TA6J300	9405	2600.00	1 N
Flexion LED AC Rope 60 LED/M BLUE IP65	LHEHCPPFTA6J300	9405	2600.00	1 N
Flexion LED AC Rope 60 LED/M GREEN IP65	LHEHCPPHTA6J300	9405	2600.00	1 N
Flexion LED AC Rope 60 LED/M RED IP65	LHEHCPPGTA6J300	9405	2600.00	1 N
Flexion LED AC Rope 60 LED/M PINK IP65	LHEHCPPKTA6J300	9405	2600.00	1 N
Flexion LED AC Rope 60 LED/M ICE BLUE IP65	LHEHCPPFNA6J300	9405	2600.00	1 N
Flexion LED AC Rope 60 LED/M PURPLE IP65	LHEHCPPYBNA6J300	9405	2600.00	1 N
Flexion LED AC Rope 60 LED/M ORANGE IP65	LHEHCPPZBNA6J300	9405	2600.00	1 N
AC ROPE 60 LED/M Light Accessories	LSSLNX1021	9405	233.00	40 N
Tricolor Flexion LED AC Rope 120 LED/M IP65	LHEHBPP1TN6F375	9405	3249.00	1 N



Consumer LED Luminaires

LED RANGE - LED STRIPS

FLEXI-NEON LED AC STRIP

LED strips for flexible profile lighting applications with uniformity of light for perfect ambiance.

Lamp Type	Ordering Code	HSN Code	List Price in ₹ Per Unit	Master Packing (No. of Unit/s)
Flexi-Neon LED AC Strip 3000 K IP65	LHEHCPP5TN6W375	9405	12500.00	1 N
Flexi-Neon LED AC Strip 4000 K IP65	LHEHCPP6TN6W375	9405	12500.00	1 N
Flexi-Neon LED AC Strip 6500 K IP65	LHEHCPP7TN6W375	9405	12500.00	1 N
Flexi-Neon LED AC Strip BLUE IP65	LHEHCPPFTN6W375	9405	12500.00	1 N
Flexi-Neon LED AC Strip RED IP65	LHEHCPPGTN6W375	9405	12500.00	1 N
Flexi-Neon LED AC Strip GREEN IP65	LHEHCPPHTN6W375	9405	12500.00	1 N
Flexi-Neon LED AC Strip PINK IP65	LHEHCPPKTN6W375	9405	12500.00	1 N
AC NEON Light Accessories	LSSLNW0199	9405	245.00	40 N
Flexi-Neon LED AC Strip RGB IP65	LHEHCPP1ATA6W075	9405	8200.00	4 N
AC Neon RGB Light Accessories	LSSLNX0955	9405	1200.00	5 N



NEW FLEXION LED STRIP RANGE

Flexible led strips with uniform light distribution and long lasting adhesive for perfect cove lighting solution.

Lamp Type	Ordering Code	HSN Code	List Price in ₹ Per Unit	Master Packing (No. of Unit/s)
Flexion Neo LED Strip 24 W 3000 K	LHEHDLP5UN1W024	9405	670.00	10 N
Flexion Neo Led Strip 24 W 4000 K	LHEHDLP6UN1W024	9405	670.00	10 N
Flexion Neo LED Strip 24 W 6000 K	LHEHDLP7UN1W024	9405	670.00	10 N
Flexion Neo LED Strip 24 W Blue	LHEHDLPFUN1W024	9405	670.00	10 N
Flexion Neo LED Strip 24 W RED	LHEHDLPGUN1W024	9405	670.00	10 N
Flexion Neo LED Strip 24 W GREEN	LHEHDLPHUN1W024	9405	670.00	10 N
Flexion Neo LED Strip 24 W PINK	LHEHDLPKUN1W024	9405	670.00	10 N
Flexion LED Strip 24 W RGB	LHEHCPPGNN1B024	9405	1575.00	10 N
Constant Voltage 12 V 2 A DRIVER	LSSLNW0150	9405	455.00	10 N
Flexion Profile Strip 36 W 120D WW	LHEHDKP5UN1W036	9405	1000.00	5 N
Flexion Profile Strip 36 W 120D NW	LHEHDKPNUN1W036	9405	1000.00	5 N
Flexion Profile Strip 36 W 120D W	LHEHDKP6UN1W036	9405	1000.00	5 N
Flexion Profile Strip 36 W 120D B	LHEHDKPFUN1W036	9405	1000.00	5 N
Constant Voltage 12 V 3 A DRIVER	LSSLNW0136	9405	550.00	10 N
Flexion LED Strip 48 W 3000 K	LHEHCPP5UN1W048	9405	1310.00	10 N
Flexion LED Strip 48 W 4000 K	LHEHCPP6UN1W048	9405	1310.00	10 N
Flexion LED Strip 48 W 6000 K	LHEHCPP7UN1W048	9405	1310.00	10 N
Flexion LED Strip 48 W BLUE	LHEHCPPFUN1W048	9405	1310.00	10 N
Constant Voltage 24 V 2 A DRIVER	LSSLNW0151	9405	865.00	10 N
Flexion Profile Strip 60 W 240D WW	LHEHDKP5UN1W060	9405	1900.00	5 N
Flexion Profile Strip 60 W 240D NW	LHEHDKPNUN1W060	9405	1900.00	5 N
Flexion Profile Strip 60 W 240D W	LHEHDKP6UN1W060	9405	1900.00	5 N
Flexion Profile Strip 60 W 240D B	LHEHDKPFUN1W060	9405	1900.00	5 N
Constant Voltage Led Driver up to 60W	LSSLNW0252	9405	970.00	20 N





Home Décor Lighting Collection

Introducing the new range of home décor lights from Havells. This range is yet another example of Havells' endeavour to innovate and provide world class lighting solutions. Modern and stylish, these lights are designed to breathe life into your living spaces, be it bedroom, living room, dining areas, staircases, corridors or dressing rooms. Just switch on these lights, and see how your dream house brightens up every day.

GLAZE

Decorative, wall mounting fixture, in durable plastic body & designer mesh in gold finish suitable for 9 W LED lamp. Also available in white/blue/black mesh on special request.

Lamp Type	Ordering Code	HSN Code	List Price in ₹ Per Unit	Master Packing (No. of Unit/s)
1 N x 9 W LED Lamp/ 1 N x 7.5 W LED Filament Lamp	LHFOECE1TZ1B014	9405	820.00	8 N



STYLO

Decorative, wall mounting, champagne gold finish fixture with plastic body suitable for 9 W LED lamp B22 base.

Lamp Type	Ordering Code	HSN Code	List Price in ₹ Per Unit	Master Packing (No. of Unit/s)
Upto 1 N x 9 W LED Lamp/ 1 N x 7.5 W A60 LED Filament Lamp	LHFOECE1TZ10014	9405	807.00	8 N



SANA

Decorative wall light made up of high grade engineering plastic material suitable for 9 W LED lamp B22 base.

Lamp Type	Ordering Code	HSN Code	List Price in ₹ Per Unit	Master Packing (No. of Unit/s)
Upto 1 N x 9 W LED Lamp/ 1 N x 7.5 W A60 LED Filament Lamp	LHFOGBE1TZ1W035	9405	856.00	12 N



FLORET

Decorative wall light made up of high grade engineering plastic material suitable for 9 W LED lamp B22 base.

Lamp Type	Ordering Code	HSN Code	List Price in ₹ Per Unit	Master Packing (No. of Unit/s)
Upto 1 N x 9 W LED Lamp/ 1 N x 7.5 W A60 LED Filament Lamp	LHFHCHE1TL1W020	9405	702.00	12 N



FLORETTE WL 1LS E14 CRM

Decorative, wall mounting, brushed nickle finish fixture with opal glass diffuser suitable for 4 W LED filament lamp E14 base.

Lamp Type	Ordering Code	HSN Code	List Price in ₹ Per Unit	Master Packing (No. of Unit/s)
1 N x 4 W A45/Candle LED Filament Lamp	LHFOAIC1TZ1C040	9405	1999.00	6 N



FLORETINE WL 1LS E27 CRM

Decorative, wall mounting, chrome finish fixture with opal glass diffuser suitable for 7.5 W A60 LED filament lamp E27 base.

Lamp Type	Ordering Code	HSN Code	List Price in ₹ Per Unit	Master Packing (No. of Unit/s)
1 N x 7.5 W A60 LED Filament Lamp	LHFOAJD1TZ1C060	9405	2090.00	4 N



FLORETINE WL 1LS E27 ABR

Decorative, wall mounting, antique brass finish fixture with opal glass diffuser suitable for 7.5 W A60 LED filament lamp E27 base.

Lamp Type	Ordering Code	HSN Code	List Price in ₹ Per Unit	Master Packing (No. of Unit/s)
1 N x 7.5 W A60 LED Filament Lamp	LHFOAJD1TZ1T060	9405	2090.00	4 N



FLORETINE WL 1LS B22 SS

Decorative, wall mounting, brushed nickel finish fixture with Opal Glass diffuser suitable with 9 W LED lamp B22 base.

Lamp Type	Ordering Code	HSN Code	List Price in ₹ Per Unit	Master Packing (No. of Unit/s)
1 N x 9 W LED Lamp/ 1 N x 7.5 W LED filament lamp	LHFOAJE1TZ11060	9405	1680.00	8 N



FLORETINE WL 2LS B22 SS

Decorative, wall mounting, brushed nickel finish fixture with Opal Glass diffuser suitable with 9 W LED lamp B22 base.

Lamp Type	Ordering Code	HSN Code	List Price in ₹ Per Unit	Master Packing (No. of Unit/s)
2 N x 9 W LED Lamp/ 2 N x 7.5 W LED filament lamp	LHFOAJE2TZ11060	9405	3082.00	4 N

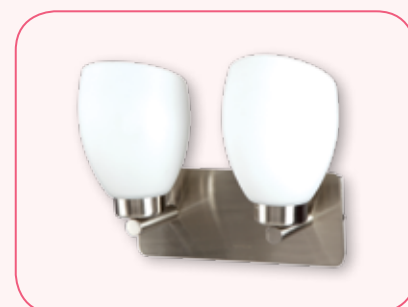

FLORETINE WL 1LS B22 SS PPCP

Decorative, wall mounting, brushed nickel finish fixture with acrylic diffuser suitable with 9 W LED lamp B22 base.

Lamp Type	Ordering Code	HSN Code	List Price in ₹ Per Unit	Master Packing (No. of Unit/s)
1 N x 9 W LED Lamp/ 1 N x 7.5 W LED filament lamp	LHFOAJE1TN11060	9405	1291.00	12 N



GOBLETO WL 1LS E27 GLD

Decorative wall light, gold finish fixture with white glass diffuser suitable for 7.5 W LED filament lamp E27 base.

Lamp Type	Ordering Code	HSN Code	List Price in ₹ Per Unit	Master Packing (No. of Unit/s)
1 N x 9 W LED Lamp/ 1 N x 7.5 W LED filament lamp	LHFOAKD1TZ1D060	9405	2600.00	4 N



GOBLETO WL 2LS E27 GLD

Decorative wall light, gold finish fixture with white glass diffuser suitable for 7.5 W LED filament lamp E27 base.

Lamp Type	Ordering Code	HSN Code	List Price in ₹ Per Unit	Master Packing (No. of Unit/s)
1 N x 9 W LED Lamp/ 2 N x 7.5 W LED filament lamp	LHFOAKD2TZ1D060	9405	4900.00	2 N

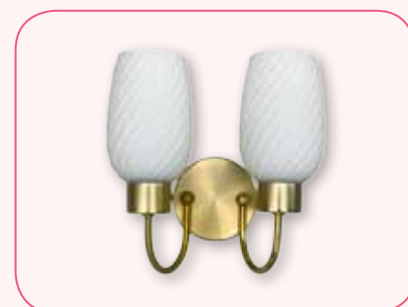

FLORETTE WL 1LS E27 SS

Decorative wall light, stainless steel, rust free fixture with white glass diffuser suitable for 7.5 W LED filament lamp E27 base.

Lamp Type	Ordering Code	HSN Code	List Price in ₹ Per Unit	Master Packing (No. of Unit/s)
1 N x 9 W LED Lamp/ 1 N x 7.5 W LED filament lamp	LHFOAID1TZ1I040	9405	2700.00	4 N



FLORETINE WL 1LS E27 SS

Decorative wall light, stainless steel, rust free fixture with white glass diffuser suitable for 7.5 W LED filament lamp E27 base.

Lamp Type	Ordering Code	HSN Code	List Price in ₹ Per Unit	Master Packing (No. of Unit/s)
1 N x 9 W LED Lamp/ 1 N x 7.5 W LED filament lamp	LHFOAJD1TZ1I060	9405	2700.00	4 N



FLORETINE WL 1LS E27 CGN

Decorative wall light, gold finish fixture with cognac hammered glass diffuser suitable for 7.5 W LED filament lamp E27 base.

Lamp Type	Ordering Code	HSN Code	List Price in ₹ Per Unit	Master Packing (No. of Unit/s)
1 N x 9 W LED Lamp/ 1 N x 7.5 W LED filament lamp	LHFOAJD1TZ1A060	9405	2300.00	4 N



SPARKLER WL 1LS E27 BRS

Minimalistic design of wall lights without shade in different finish and design in E27 base. Recommended to use with energy saving filament lamps.

Lamp Type	Ordering Code	HSN Code	List Price in ₹ Per Unit	Master Packing (No. of Unit/s)
1 N x 7.5 W LED Filament Lamp	LHFHANDBTN1O007	9405	1800.00	4 N

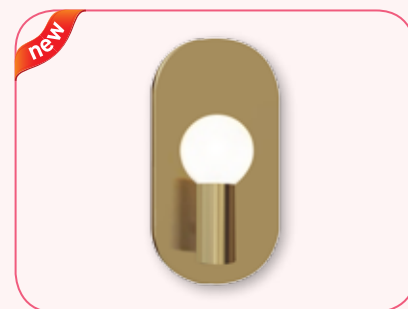

SPARKLER WL 1LS E27 ABS BL PC

Minimalistic design of wall lights without shade in different finish and design in E27 base. Recommended to use with energy saving filament lamps.

Lamp Type	Ordering Code	HSN Code	List Price in ₹ Per Unit	Master Packing (No. of Unit/s)
1 N x 7.5 W LED Filament Lamp	LHFHANDBTN1T007	9405	1601.00	4 N



SPARKLER WL 1LS E27 BRS BL PC

Minimalistic design of wall lights without shade in different finish and design in E27 base. Recommended to use with energy saving filament lamps.

Lamp Type	Ordering Code	HSN Code	List Price in ₹ Per Unit	Master Packing (No. of Unit/s)
1 N x 7.5 W LED Filament Lamp	LHFHANDBTN1K007	9405	1800.00	4 N



SPARKLER WL 1LS E27 COP WHT PC

Minimalistic design of wall lights without shade in different finish and design in E27 base. Recommended to use with energy saving filament lamps.

Lamp Type	Ordering Code	HSN Code	List Price in ₹ Per Unit	Master Packing (No. of Unit/s)
1 N x 7.5 W LED Filament Lamp	LHFHANDBTN1M007	9405	1601.00	4 N



GLOBE

Decorative wall light fixture made up of Polycarbonate, suitable for 9 W LED lamp B22 base.

Lamp Type	Ordering Code	HSN Code	List Price in ₹ Per Unit	Master Packing (No. of Unit/s)
Upto 1 N x 9 W LED Lamp	LHFOFUE1TZ1W012	9405	678.00	12 N



MARS

Decorative wall light fixture made up of Polycarbonate, suitable for 9 W LED lamp B22 base.

Lamp Type	Ordering Code	HSN Code	List Price in ₹ Per Unit	Master Packing (No. of Unit/s)
Upto 1 N x 9 W LED Lamp	LHFOFWE1TZ1W012	9405	678.00	12 N



APPLE

Decorative wall light fixture made up of Polycarbonate, suitable for 9 W LED lamp B22 base.

Lamp Type	Ordering Code	HSN Code	List Price in ₹ Per Unit	Master Packing (No. of Unit/s)
Upto 1 N x 9 W LED Lamp	LHFOFTE1TZ1W012	9405	678.00	12 N



CITY 1

Decorative wall light fixture made up of Polycarbonate, suitable for 9 W retrofit LED lamp B22 base.

Lamp Type	Ordering Code	HSN Code	List Price in ₹ Per Unit	Master Packing (No. of Unit/s)
Upto 1 N x 9 W LED Lamp	LHDL02160099	9405	1004.00	12 N



CITY 2

Decorative wall light fixture made up of Polycarbonate, suitable for 9 W retrofit LED lamp B22 base.

Lamp Type	Ordering Code	HSN Code	List Price in ₹ Per Unit	Master Packing (No. of Unit/s)
Upto 1 N x 9 W LED Lamp	LHDL03160099	9405	1004.00	12 N



CITY 3

Decorative wall light fixture made up of Polycarbonate, suitable for 9 W retrofit LED Lamp B22 base.

Lamp Type	Ordering Code	HSN Code	List Price in ₹ Per Unit	Master Packing (No. of Unit/s)
Upto 1 N x 9 W LED Lamp	LHDL06160099	9405	1029.00	12 N



LEXO (PRISMATIC)

Decorative gate light made up of high grade unbreakable polycarbonate material suitable for 20 W LED lamp B22 base.

Lamp Type	Ordering Code	HSN Code	List Price in ₹ Per Unit	Master Packing (No. of Unit/s)
1 N x 20 W LED Lamp	LHFOGAE1T11F015	9405	924.00	12 N

Mounting Pole Dia - 60 mm (max) OD.
Dimension: Width: 189 mm & Height: 216 mm.



RUBIX

Decorative gate light made up of high grade unbreakable polycarbonate material suitable for retrofit 9 W lamp B22 base.

Lamp Type	Ordering Code	HSN Code	List Price in ₹ Per Unit	Master Packing (No. of Unit/s)
Upto 1 N x 9 W LED Lamp	LHFOGAE1T11Q020	9405	949.00	4 N

Mounting CD - 2 Holes Ø 3.5 mm at CD 124 mm.
Dimension: Width: 191 mm & Height: 425 mm.

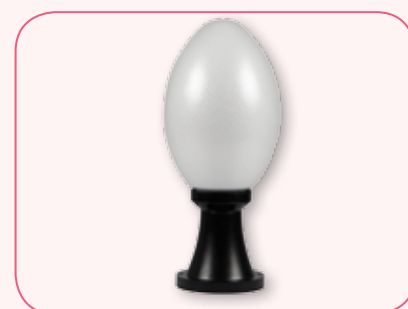

MOON (PRISMATIC)

Decorative gate light made up of high grade unbreakable polycarbonate material suitable for retrofit LED lamp B22 base.

Lamp Type	Ordering Code	HSN Code	List Price in ₹ Per Unit	Master Packing (No. of Unit/s)
Upto 1 N x 7 W LED Lamp - Moon 150	LHFXBON1TN6F023	9405	567.00	12 N
Upto 1 N x 20 W LED Lamp - Moon 200	LHFXBON1TN6F035	9405	789.00	12 N

Mounting Pole Dia - 60 mm (max) OD. Dimension: Width: 150 mm & Height: 182 mm for Moon 150.
Mounting Pole Dia - 60 mm (max) OD. Dimension: Width: 200 mm & Height: 227 mm for Moon 200.



MOON (OPAL)

Decorative gate light made up of high grade unbreakable polycarbonate material suitable for retrofit LED lamp B22 base.

Lamp Type	Ordering Code	HSN Code	List Price in ₹ Per Unit	Master Packing (No. of Unit/s)
Upto 1 N x 7 W LED Lamp - Moon 150	LHFXBON1TN5Q008	9405	609.00	12 N
Upto 1 N x 20 W LED Lamp - Moon 200	LHFXBON1TN5Q014	9405	875.00	12 N
Upto 1 N x 20 W LED Lamp - Moon 250	LHFXBON1TN5Q020	9405	1232.00	8 N

Mounting Pole Dia - 60 mm (max) OD. Dimension: Width: 150 mm & Height: 182 mm for Moon 150.
Mounting Pole Dia - 60 mm (max) OD. Dimension: Width: 200 mm & Height: 227 mm for Moon 200.
Mounting Pole Dia - 60 mm (max) OD. Dimension: Width: 242 mm & Height: 250 mm for Moon 250.



MUSHROOM (PRISMATIC)

Decorative gate light made up of high grade unbreakable polycarbonate material suitable for retrofit LED lamp B22 base.

Lamp Type	Ordering Code	HSN Code	List Price in ₹ Per Unit	Master Packing (No. of Unit/s)
Upto 1 N x 7 W LED Lamp	LHFXBON1TN6F023	9405	567.00	12 N
Upto 1 N x 20 W LED Lamp	LHFXAMN1TN6F035	9405	789.00	12 N

Mounting Pole Dia - 60 mm (max) OD.
Dimension: Width: 214 mm & Height: 250 mm.



ATHENA 1 (OPAL)

Crown shaped post top lantern in soothing opal finish made up of Polycarbonate, suitable LED lamp B22 base.

Lamp Type	Ordering Code	HSN Code	List Price in ₹ Per Unit	Master Packing (No. of Unit/s)
Upto 1 N x 20 W LED Lamp	LHDC10115099	9405	881.00	12 N

Mounting Pole Dia - 60 mm (max) OD.
Dimension: Width: 200 mm & Height: 235 mm.



ATHENA 3 (MOON)

Crown shaped post top lantern in soothing moon finish made up of Polycarbonate, suitable LED lamp B22 base.

Lamp Type	Ordering Code	HSN Code	List Price in ₹ Per Unit	Master Packing (No. of Unit/s)
1 N x 20 W LED Lamp	LHDC11126099	9405	1448.00	12 N

Mounting Pole Dia - 60 mm (max) OD.
Dimension: ø 230 mm & Height: 328 mm.



ARCH 1 GATE LIGHT

Gate light in aluminum die cast with modern artistic design and white PC diffuser suitable for retrofit LED lamps.

Lamp Type	Ordering Code	HSN Code	List Price in ₹ Per Unit	Master Packing (No. of Unit/s)
Upto 1N x 60 W LED Lamp	LHFOAQE1NZ5K7X5	9405	2800.00	4 N

Mounting Pole Dia - 156 mm (max) OD.
Dimension: ø 189 mm & Height: 370 mm.



ARCH 2 GATE LIGHT

Gate light in aluminum die cast with modern artistic design and white PC diffuser suitable for retrofit LED lamps.

Lamp Type	Ordering Code	HSN Code	List Price in ₹ Per Unit	Master Packing (No. of Unit/s)
Upto 1N x 60 W LED Lamp	LHFOAQE1TZ5K7X5	9405	2800.00	4 N

Mounting Pole Dia - 156 mm (max) OD.
Dimension: ø 189 mm & Height: 370 mm.



NATURA GATE LIGHT CURVE

Gate light in aluminum die cast with modern artistic design and white PC diffuser suitable with LED lamp B22.

Lamp Type	Ordering Code	HSN Code	List Price in ₹ Per Unit	Master Packing (No. of Unit/s)
1N x 7.5 W LED Filament Lamp	LHFOASE1TC5W009	9405	1530.00	8 N



NATURA GATE LIGHT SQUARE

Gate light in aluminum die cast with modern artistic design and white PC diffuser suitable with LED lamp B22.

Lamp Type	Ordering Code	HSN Code	List Price in ₹ Per Unit	Master Packing (No. of Unit/s)
1N x 7.5 W LED Filament Lamp	LHFOASE1TN5W009	9405	1530.00	8 N



NATURA GATE LIGHT ROUND

Gate light in aluminum die cast with modern artistic design and white PC diffuser suitable with LED lamp B22.

Lamp Type	Ordering Code	HSN Code	List Price in ₹ Per Unit	Master Packing (No. of Unit/s)
1N x 7.5 W LED Filament Lamp	LHFOASE1TZ5W009	9405	1530.00	8 N



NUEVA GATE LIGHT CUBE

Post top lantern in soothing opal finish made up of polycarbonate, suitable LED lamp B22 base.

Lamp Type	Ordering Code	HSN Code	List Price in ₹ Per Unit	Master Packing (No. of Unit/s)
1N x 7.5 W LED Filament Lamp	LHFOATE1TC5W009	9405	855.00	8 N



NUEVA GATE LIGHT OVAL 1

Post top lantern in soothing opal finish made up of polycarbonate, suitable LED lamp B22 base.

Lamp Type	Ordering Code	HSN Code	List Price in ₹ Per Unit	Master Packing (No. of Unit/s)
1N x 7.5 W LED Filament Lamp	LHFOATE1TN5W009	9405	855.00	8 N



NUEVA GATE LIGHT OVAL 2

Post top lantern in soothing opal finish made up of polycarbonate, suitable LED lamp B22 base.

Lamp Type	Ordering Code	HSN Code	List Price in ₹ Per Unit	Master Packing (No. of Unit/s)
1N x 7.5 W LED Filament Lamp	LHFOATE1TZ5W009	9405	855.00	8 N



NUEVA GATE LIGHT ACCESSORY PEDESTAL

Lamp Type	Ordering Code	HSN Code	List Price in ₹ Per Unit	Master Packing (No. of Unit/s)
NA	LSSLNB0058	9405	225.00	12 N



PRISTINE SPIKE LED LIGHT

Premium category of LED Spike Light suitable for outdoor environment with IP65 that beautify transforms the beauty of your space.

Lamp Type	Ordering Code	HSN Code	List Price in ₹ Per Unit	Master Packing (No. of Unit/s)
7 W LED 3000 K	LHEVACBPBN6K007	94054200	1520.00	8 N
10 W LED 3000 K	LHEVACBPBN6K010	94054200	1800.00	8 N



BRILLANTE LINEAR WALL WASHER

Crafted from Aluminum Die Cast with Bi-Directional Beam. Its integrated LED ensures long-lasting and energy-efficient with IP65 Protected.

Lamp Type	Ordering Code	HSN Code	List Price in ₹ Per Unit	Master Packing (No. of Unit/s)
2H 2 W 3000 K	LHEVADBPBN6K002	94051100	2200.00	12 N



BRILLANTE LINEAR WALL WASHER

Crafted from Aluminum Die Cast with Bi-Directional Beam. Its integrated LED ensures long-lasting and energy-efficient with IP65 Protected.

Lamp Type	Ordering Code	HSN Code	List Price in ₹ Per Unit	Master Packing (No. of Unit/s)
4H 4 W 3000 K	LHEVADBPBN6K004	94051100	2900.00	8 N



BRILLANTE LINEAR WALL WASHER

Crafted from Aluminum Die Cast with Bi-Directional Beam. Its integrated LED ensures long-lasting and energy-efficient with IP65 Protected.

Lamp Type	Ordering Code	HSN Code	List Price in ₹ Per Unit	Master Packing (No. of Unit/s)
6H 7 W 3000 K	LHEVADBPBN6K007	94051100	3500.00	6 N



Home Décor

OUTDOOR LED / LED TABLE LAMPS / PENDANT RANGE

BRILLANTE ROUND WALL WASHER

Crafted from Aluminum Die Cast with Four-Directional Beam. Its integrated LED ensures long-lasting and energy-efficient with IP65 Protected.

Lamp Type	Ordering Code	HSN Code	List Price in ₹ Per Unit	Master Packing (No. of Unit/s)
2H 4 W 3 K	LHEVAEPBPN6K004	94051100	2350.00	12 N



BRILLANTE ROUND WALL WASHER

Crafted from Aluminum Die Cast with Four-Directional Beam. Its integrated LED ensures long-lasting and energy-efficient with IP65 Protected.

Lamp Type	Ordering Code	HSN Code	List Price in ₹ Per Unit	Master Packing (No. of Unit/s)
4H 7 W 3 K	LHEVAEPBPN6K007	94051100	3000.00	8 N



DESKLITE KITTY

DeskLITE Kitty for kids with adjustable lamp shade, touch switch to change brightness.

Lamp Type	Ordering Code	HSN Code	List Price in ₹ Per Unit	Master Packing (No. of Unit/s)
7 W 4000 K Pink	LHEXBVP7SN1W007	9405	3100.00	4 N
7 W 4000 K Blue	LHEXBVP6SN1B007	9405	3100.00	4 N



NIMBUS

Decorative, surface mounting, dome shaped pendant in green & black finishes.

Lamp Type	Ordering Code	HSN Code	List Price in ₹ Per Unit	Master Packing (No. of Unit/s)
Upto 7.5 W A60 LED Filament Lamp Black	LHFHDPE1TN1K020	9405	2137.00	4 N

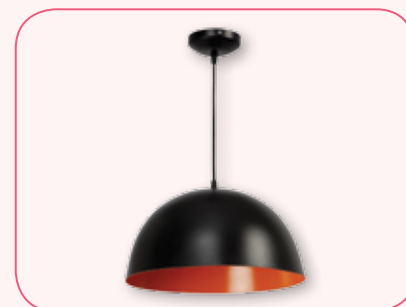



LED Lamps

High output LED lamps, specialized high wattage lamps and decorative LED Filament lamps for all household and commercial needs.



Description	Ordering Code	Lumen Output (lm)	Color Temp. (K)	Lamp Dimension (mm)		Lamp Current (A)	Base Cap	HSN Code	MRP Rs. Per Unit (incl. of all taxes)	Master Packing (No. of Unit/s)
				Length	Dia.					
Adore Deco LED 0.5 W B22 MultiColor Lamp	LHLDATEAMANR0X5	NA	Multicolor	70	45	0.025 A	B22	85395200	110.00	60 N
LED Adore Lamp 0.5 W B22 White	LHLDAFUEULNX0X5	NA	White	70	45	0.05 A	B22	85395200	45.00	60 N
LED Adore Lamp 0.5 W B22 Yellow	LHLDAFUEUCNX0X5	NA	Yellow	70	45	0.05 A	B22	85395200	45.00	60 N
LED Adore Lamp 0.5 W B22 Green	LHLDAFUEUONX0X5	NA	Green	70	45	0.05 A	B22	85395200	45.00	60 N
LED Adore Lamp 0.5 W B22 Blue	LHLDAFUEUSNX0X5	NA	Blue	70	45	0.05 A	B22	85395200	45.00	60 N
LED Adore Lamp 0.5 W B22 Red	LHLDAFUEUPNX0X5	NA	Red	70	45	0.05 A	B22	85395200	45.00	60 N
LED Adore Lamp 0.5 W B22 Pink	LHLDAFUEUYNX0X5	NA	Pink	70	45	0.05 A	B22	85395200	45.00	60 N
LED Adore Lamp 0.5 W B22 Orange	LHLDAFUEUJNX0X5	NA	Orange	70	45	0.05 A	B22	85395200	45.00	60 N
Adore Deco LED 0.5 W Plug WW Lamp	LHLDATNAMDNR0X5	NA	3000K	67	45	0.15 A	2 Pin	85395200	130.00	48 N
Adore Deco LED 0.5 W Plug CDL Lamp	LHLDATNAMLNR0X5	NA	6500K	67	45	0.15 A	2 Pin	85395200	130.00	48 N
LED Adore 2.8 W B22 CDL Candle Lamp	LHLDEUEEML8R2X8	240	6500 K	100	37	0.16 A	B22	85395200	120.00	40 N
LED Adore 2.8 W B22 WW Candle Lamp	LHLDEUEEMC8R2X8	210	3000 K	100	37	0.16 A	B22	85395200	120.00	40 N
LED Adore 2.8 W E27 CDL Candle Lamp	LHLDEUHCML8R2X8	240	6500 K	100	37	0.16 A	E27	85395200	120.00	40 N
LED Adore 2.8 W E27 WW Candle Lamp	LHLDEUHEMC8R2X8	210	3000 K	100	37	0.16 A	E27	85395200	120.00	40 N
LED Adore 2.8 W E14 CDL Candle Lamp	LHLDEUOCML8R2X8	240	6500 K	100	37	0.16 A	E14	85395200	120.00	40 N
LED Adore 2.8 W E14 WW Candle Lamp	LHLDEUOCMC8R2X8	210	3000 K	100	37	0.16 A	E14	85395200	120.00	40 N
LED Adore 2.8 W B22 CDL Ball Lamp	LHLDEUECML8R2X8	240	6500 K	82	45	0.16 A	B22	85395200	120.00	40 N
LED Adore 2.8 W B22 WW Ball Lamp	LHLDEUECMC8R2X8	210	3000 K	82	45	0.16 A	B22	85395200	120.00	40 N
LED Adore 2.8 W E27 CDL Ball Lamp	LHLDEUHCML8Z2X8	240	6500 K	82	45	0.16 A	E27	85395200	120.00	40 N
LED Adore 2.8 W E27 WW Ball Lamp	LHLDEUHCML8R2X8	210	3000 K	82	45	0.16 A	E27	85395200	120.00	40 N
LED Adore 2.8 W E14 CDL Ball Lamp	LHLDEUOEML8R2X8	240	6500 K	82	45	0.16 A	E14	85395200	120.00	40 N
LED Adore 2.8 W E14 WW Ball Lamp	LHLDEUOEMC8R2X8	210	3000 K	82	45	0.16 A	E14	85395200	120.00	40 N
COMFY VIZON LED 12 W B22 CDL 3 STAR	LHLDDDEAID4R012	1260	6500 K	109	61	0.055 A	B22	85395200	280.00	50 N
COMFY VIZON LED 12 W E27 CDL 3 STAR	LHLDDDHAI4R012	1260	6500 K	110	61	0.055 A	E27	85395200	280.00	50 N

LED Lamps

INVERTER LED / ROJO / NU-BULB+ & CLASSY LED LAMPS

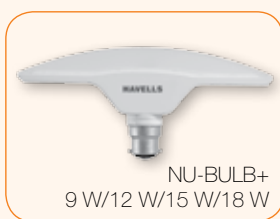
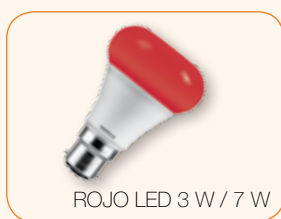

Description	Ordering Code	Lumen Output (lm)	Color Temp. (K)	Lamp Dimension (mm)			Lamp Current (A)	Base Cap	HSN Code	MRP Rs. Per Unit (incl. of all taxes)	Master Packing (No. of Unit/s)
				Length	Width	Height					
LED 9 W INVERTER BULB B22 CDL	LHLDEGEDML80009	900	6500 K	140	70	—	0.045 A	B22	85395200	549.00	24 N
LED 12 W B22 CDL INVERTER BULB	LHLDDDBAIA2R012	1200	6500 K	140	70	NA	0.055 A	B22	85395200	649.00	24 N
LED ROJO 7 W B22 RED LAMP	LHLDBWEB4P8R007	30	Red	100	Ø 70	--	0.035 A	B22d	85395200	199.00	20 N
LED ROJO 7 W B22 GREEN LAMP	LHLDBWEB4O8R007	180	Green	100	Ø 70	--	0.035 A	B22d	85395200	199.00	20 N
LED ROJO 7 W B22 BLUE LAMP	LHLDBWEB4S8R007	25	Blue	100	Ø 70	--	0.035 A	B22d	85395200	199.00	20 N
LED ROJO 7 W B22 YELLOW LAMP	LHLDBWEB4C8R007	350	Yellow	100	Ø 70	--	0.035 A	B22d	85395200	199.00	20 N
LED ROJO 3 W B22 RED LAMP	LHLDDDBANE4R003	13	Red	80	55	--	0.020 A	B22	85395200	160.00	50 N
LED ROJO 3 W B22 GREEN LAMP	LHLDDDBBNE4R003	80	Green	80	55	--	0.020 A	B22	85395200	160.00	50 N
LED ROJO 3 W B22 BLUE LAMP	LHLDDDBCNE4R003	11	Blue	80	55	--	0.020 A	B22	85395200	160.00	50 N
LED ROJO 3 W B22 YELLOW LAMP	LHLDDDBDNE4R003	150	Yellow	80	55	--	0.020 A	B22	85395200	160.00	50 N
LED ROJO 3 W B22 PINK LAMP	LHLDDDEBIY4R003	30	Pink	80	55	--	0.020 A	B22	85395200	160.00	50 N
NU BULB PLUS 9 W 865 B22 3 STAR	LHLDEUECNL8R009	945	6500 K	206	30	90	0.050 A	B22	85395200	300.00	10 N
NU BULB PLUS 12 W 865 B22 2 STAR	LHLDEUECNL8R012	1200	6500 K	206	30	90	0.065 A	B22	85395200	350.00	10 N
NU BULB PLUS 15 W 865 B22 3 STAR	LHLDEUECNL9R015	1575	6500 K	280	30	93.5	0.070 A	B22	85395200	400.00	10 N
NU BULB PLUS 18 W 865 B22 2 STAR	LHLDEUECNL9R018	1800	6500 K	280	30	93.5	0.085 A	B22	85395200	450.00	10 N
CLASSY LED 15 W B22 CDL 3 STAR	LHLDEUEEML8R015	1575	6500 K	128	65	--	0.07 A	B22	85395200	300.00	30 N
CLASSY LED 15 W E27 CDL 3 STAR	LHLDEUHEML8R015	1575	6500 K	128	65	--	0.07 A	E27	85395200	300.00	30 N
CLASSY LED 15 W B22 WW 2 STAR	LHLDEUEEMD8R015	1350	3000 K	128	65	--	0.07 A	B22	85395200	300.00	30 N
CLASSY LED 15 W E27 WW 2 STAR	LHLDEUHEMD8R015	1350	3000 K	128	65	--	0.07 A	E27	85395200	300.00	30 N
CLASSY LED 13 W B22 CDL 3 STAR	LHLDEUEEML8R013	1365	6500 K	128	65	--	0.07 A	B22	85395200	295.00	30 N
CLASSY LED 13 W E27 CDL 3 STAR	LHLDEUHEML8R013	1365	6500 K	128	65	--	0.07 A	E27	85395200	295.00	30 N
LED CLASSY 17 W 3 STAR B22 CDL V3	LHLDDDEAID3R017	1785 lm	6500 K	NA	65	126	0.10 A	B22	85395200	400.00	30 N
LED CLASSY 17 W 3 STAR E27 CDL V3	LHLDDDHBD3R017	1785 lm	6500 K	NA	65	126	0.10 A	E27	85395200	400.00	30 N
LED CLASSY 17 W 2 STAR B22 WW V3	LHLDDDEDID3R017	1530 lm	3000 K	NA	65	126	0.10 A	B22	85395200	400.00	30 N
LED CLASSY 17 W 2 STAR E27 WW V3	LHLDDDEHEID3R017	1530 lm	3000 K	NA	65	126	0.10 A	E27	85395200	400.00	30 N



Description	Ordering Code	Lumen Output (lm)	Color Temp. (K)	Lamp Dimension (mm)		Lamp Current (A)	Base Cap	HSN Code	MRP Rs. Per Unit (incl. of all taxes)	Master Packing (No. of Unit/s)
				Length	Dia.					
LED ADORE PLUS 5 W B22 CDL 3 STAR LAMP	LHLDDDECBD2R005	525	6500 K	100	55	0.03 A	B22	85395200	130.00	50 N
LED ADORE PLUS 5 W E27 CDL 3 STAR LAMP	LHLDDDBEBD2R005	525	6500 K	101	55	0.03 A	E27	85395200	130.00	50 N
LED ADORE PLUS 5 W B22 WW 2 STAR LAMP	LHLDDDEC1D2R005	501	3000 K	100	55	0.03 A	B22	85395200	130.00	50 N
LED ADORE PLUS 5 W E27 WW 2 STAR LAMP	LHLDDDEE1D2R005	501	3000 K	101	55	0.03 A	E27	85395200	130.00	50 N
LED ADORE PLUS 7 W B22 CDL 3 STAR LAMP	LHLDDDBEBI2R007	735	6500 K	106	60	0.04 A	B22	85395200	140.00	50 N
LED ADORE PLUS 7 W E27 CDL 3 STAR LAMP	LHLDDDBEID2R007	735	6500 K	107	60	0.04 A	E27	85395200	140.00	50 N
LED ADORE PLUS 7 W B22 WW 2 STAR LAMP	LHLDDDBCBD2R007	630	3000 K	106	60	0.04 A	B22	85395200	140.00	50 N
LED ADORE PLUS 7 W E27 WW 2 STAR LAMP	LHLDDDECBD2R007	630	3000 K	107	60	0.04 A	E27	85395200	140.00	50 N
LED ADORE PLUS 9 W B22 CDL 3 STAR LAMP	LHLDDBEBI8R009	950	6500 K	113	60	0.055 A	B22	85395200	150.00	50 N
LED ADORE PLUS 9 W E27 CDL 3 STAR LAMP	LHLDDDBEIB2R009	950	6500 K	114	60	0.055 A	E27	85395200	150.00	50 N
LED ADORE PLUS 9 W B22 WW 2 STAR LAMP	LHLDDDBEBI2R009	810	3000 K	113	60	0.055 A	B22	85395200	150.00	50 N
LED ADORE PLUS 9 W E27 WW 2 STAR LAMP	LHLDDDECBD2R009	810	3000 K	114	60	0.055 A	E27	85395200	150.00	50 N
LED ADORE PLUS 10 W B22 CDL 2 STAR LAMP	LHLDDDEAIA5R010	950	6500 K	113	60	0.055 A	B22	85395200	150.00	50 N
LED ADORE PLUS 10 W E27 CDL 2 STAR LAMP	LHLDDDHBAIA5R010	950	6500 K	114	60	0.055 A	E27	85395200	150.00	50 N
LED ADORE 20 W B22 CDL 2 STAR V2	LHLDEUEEMK8R020	2000	6500 K	122	66	0.10 A	B22	85395200	415.00	30 N
LED ADORE 20 W E27 CDL 2 STAR V2	LHLDEUHEMK8R020	2000	6500 K	123	66	0.10 A	E27	85395200	415.00	30 N
LED ADORE 20 W B22 WW 2 STAR V2	LHLDEUEEMD8R020	1800	3000 K	122	66	0.10 A	B22	85395200	415.00	30 N
LED ADORE PLUS 20 W B22 CDL 2 STAR	LHLDDDENIC2R020	2000	6500K	NA	80	0.096 A	B22	85395200	415.00	30 N
LED ADORE PLUS 20 W E27 CDL 2 STAR	LHLDDDHNDI2R020	2000	6500K	NA	80	0.096 A	E27	85395200	415.00	30 N
LED ADORE PLUS 20 W B22 WW 2 STAR	LHLDDDNNDI2R020	1800	3000K	NA	80	0.096 A	B22	85395200	415.00	30 N
LED ADORE PLUS 20 W E27 WW 2 STAR	LHLDDDHNDI2R020	1800	3000K	NA	80	0.096 A	E27	85395200	415.00	30 N
LED ADORE 23 W B22 CDL 3 STAR	LHLDDDBA2I2R023	2415	6500 K	153	80	0.11 A	B22	85395200	500.00	12 N
LED ADORE 23 W E27 CDL 3 STAR	LHLDDDBC2I2R023	2415	6500 K	153	80	0.11 A	E27	85395200	500.00	12 N
LED ADORE 23 W B22 WW 2 STAR	LHLDDDBD2I2R023	2070	3000 K	151	81	0.11 A	B22	85395200	500.00	12 N
LED ADORE 23 W E27 WW 2 STAR	LHLDDDBE2I2R023	2070	3000 K	152	81	0.11 A	E27	85395200	500.00	12 N
LED PLUS 5 W B22 CDL 2 STAR LAMP	LHLDDDEAIA4R005	501	6500 K	100	55	0.03 A	B22	85395200	130.00	50N
LED PLUS 5 W E27 CDL 2 STAR LAMP	LHLDDDHBAIB5R005	501	6500 K	101	55	0.03 A	E27	85395200	130.00	50N
LED PLUS 5 W B22 WW 2 STAR LAMP	LHLDDDENIC5R005	501	3000 K	100	55	0.03 A	B22	85395200	130.00	50N
LED PLUS 5 W E27 WW 2 STAR LAMP	LHLDDDHNDI5R005	501	3000 K	101	55	0.03 A	E27	85395200	130.00	50N
LED PLUS 7 W B22 CDL 2 STAR LAMP	LHLDDDEAIA4R007	700	6500 K	106	60	0.04 A	B22	85395200	140.00	50N
LED PLUS 7 W E27 CDL 2 STAR LAMP	LHLDDDHBAIA4R007	700	6500 K	107	60	0.04 A	E27	85395200	140.00	50N
LED PLUS 7 W B22 WW 2 STAR LAMP	LHLDDDENIC5R007	630	3000 K	106	60	0.04 A	B22	85395200	140.00	50N
LED PLUS 7 W E27 WW 2 STAR LAMP	LHLDDDHNDI5R007	630	3000 K	107	60	0.04 A	E27	85395200	140.00	50N
LED PLUS 9 W B22 CDL 2 STAR LAMP	LHLDDDEBIA5R009	850	6500 K	113	60	0.05 A	B22	85395200	150.00	50N
LED PLUS 9 W E27 CDL 2 STAR LAMP	LHLDDDHBAIA5R009	850	6500 K	114	60	0.05 A	E27	85395200	150.00	50N
LED PLUS 9 W B22 WW 2 STAR LAMP	LHLDDDENIC5R009	810	3000 K	113	60	0.05 A	B22	85395200	150.00	50N
LED PLUS 9 W E27 WW 2 STAR LAMP	LHLDDDHNDI5R009	810	3000 K	114	60	0.05 A	E27	85395200	150.00	50N

LED Lamps

BELLA LED LAMPS



Description	Ordering Code	Lumen Output (lm)	Color Temp. (K)	Lamp Dimension (mm)			Lamp Current (A)	Base Cap	HSN Code	MRP Rs. Per Unit (incl. of all taxes)	Master Packing (No. of Unit/s)
				Length	Width	Height					
LED LAMP 2.9 W CDL E14 BELLA-FLORET	LHLDABOEMK8P2X9	180	6500 K	88	Ø 60	--	0.015 A	E14	85395200	150.00	20 N
LED LAMP 2.9 W WW E14 BELLA-FLORET	LHLDABOEMD8P2X9	150	3000 K	88	Ø 60	--	0.015 A	E14	85395200	150.00	20 N
LED LAMP 2.9 W RED E14 BELLA-FLORET	LHLDABOEMP8P2X9	10	RED	88	Ø 60	--	0.015 A	E14	85395200	150.00	20 N
LED LAMP 2.9 W BLUE E14 BELLA-FLORET	LHLDABOEMS8P2X9	8	BLUE	88	Ø 60	--	0.015 A	E14	85395200	150.00	20 N
LED LAMP 2.9 W GREEN E14 BELLA-FLORET	LHLDABOEMO8P2X9	60	GREEN	88	Ø 60	--	0.015 A	E14	85395200	150.00	20 N
LED LAMP 2.9 W CDL B22 BELLA-FLORET	LHLDABEEML8P2X9	180	6500 K	85	Ø 60	--	0.015 A	B22	85395200	150.00	20 N
LED LAMP 2.9 W WW B22 BELLA-FLORET	LHLDABEEMD8P2X9	150	3000 K	85	Ø 60	--	0.015 A	B22	85395200	150.00	20 N
LED LAMP 2.9 W RED B22 BELLA-FLORET	LHLDABEEMP8P2X9	10	RED	85	Ø 60	--	0.015 A	B22	85395200	150.00	20 N
LED LAMP 2.9 W BLUE B22 BELLA-FLORET	LHLDABEEMS8P2X9	8	BLUE	85	Ø 60	--	0.015 A	B22	85395200	150.00	20 N
LED LAMP 2.9 W GREEN B22 BELLA-FLORET	LHLDABEEMO8P2X9	60	GREEN	85	Ø 60	--	0.015 A	B22	85395200	150.00	20 N
LED LAMP 2.9 W CDL E27 BELLA-FLORET	LHLDABHEML8P2X9	180	6500 K	85	Ø 60	--	0.015 A	E27	85395200	150.00	20 N
LED LAMP 2.9 W WW E27 BELLA-FLORET	LHLDABHEMD8P2X9	150	3000 K	85	Ø 60	--	0.015 A	E27	85395200	150.00	20 N
LED LAMP 2.9 W RED E27 BELLA-FLORET	LHLDABHEMP8P2X9	10	RED	85	Ø 60	--	0.015 A	E27	85395200	150.00	20 N
LED LAMP 2.9 W BLUE E27 BELLA-FLORET	LHLDABHEMS8P2X9	8	BLUE	85	Ø 60	--	0.015 A	E27	85395200	150.00	20 N
LED LAMP 2.9 W GREEN E27 BELLA-FLORET	LHLDABHEMO8P2X9	60	GREEN	85	Ø 60	--	0.015 A	E27	85395200	150.00	20 N
LED LAMP 2.9 W CDL E14 BELLA-KRYSTA	LHLDAP OEMK8P2X9	85	6500 K	88	Ø 38	--	0.015 A	E14	85395200	150.00	20 N
LED LAMP 2.9 W WW E14 BELLA-KRYSTA	LHLDAP OEMD8P2X9	85	3000 K	88	Ø 38	--	0.015 A	E14	85395200	150.00	20 N
LED LAMP 2.9 W RED E14 BELLA-KRYSTA	LHLDAP OEMP8P2X9	5	RED	88	Ø 38	--	0.015 A	E14	85395200	150.00	20 N
LED LAMP 2.9 W BLUE E14 BELLA-KRYSTA	LHLDAP OEMS8P2X9	4	BLUE	88	Ø 38	--	0.015 A	E14	85395200	150.00	20 N
LED LAMP 2.9 W GREEN E14 BELLA-KRYSTA	LHLDAP OEMO8P2X9	30	GREEN	88	Ø 38	--	0.015 A	E14	85395200	150.00	20 N
LED LAMP 2.9 W CDL B22 BELLA-KRYSTA	LHLDAP EEMK8P2X9	85	6500 K	83	Ø 38	--	0.015 A	B22	85395200	150.00	20 N
LED LAMP 2.9 W WW B22 BELLA-KRYSTA	LHLDAP EEMD8P2X9	85	3000 K	83	Ø 38	--	0.015 A	B22	85395200	150.00	20 N
LED LAMP 2.9 W RED B22 BELLA-KRYSTA	LHLDAP EEMP8P2X9	5	RED	83	Ø 38	--	0.015 A	B22	85395200	150.00	20 N
LED LAMP 2.9 W BLUE B22 BELLA-KRYSTA	LHLDAP EEMS8P2X9	4	BLUE	83	Ø 38	--	0.015 A	B22	85395200	150.00	20 N
LED LAMP 2.9 W GREEN B22 BELLA-KRYSTA	LHLDAP EEMO8P2X9	30	GREEN	83	Ø 38	--	0.015 A	B22	85395200	150.00	20 N
LED LAMP 2.9 W CDL E27 BELLA-KRYSTA	LHLDAP HEMK8P2X9	85	6500 K	83	Ø 38	--	0.015 A	E27	85395200	150.00	20 N
LED LAMP 2.9 W WW E27 BELLA-KRYSTA	LHLDAP HEMD8P2X9	85	3000 K	83	Ø 38	--	0.015 A	E27	85395200	150.00	20 N
LED LAMP 2.9 W RED E27 BELLA-KRYSTA	LHLDAP HEMP8P2X9	5	RED	83	Ø 38	--	0.015 A	E27	85395200	150.00	20 N
LED LAMP 2.9 W BLUE E27 BELLA-KRYSTA	LHLDAP HEMS8P2X9	4	BLUE	83	Ø 38	--	0.015 A	E27	85395200	150.00	20 N
LED LAMP 2.9 W GREEN E27 BELLA-KRYSTA	LHLDAP HEMO8P2X9	30	GREEN	83	Ø 38	--	0.015 A	E27	85395200	150.00	20 N

ADORE JUMBO LED



Description	Ordering Code	Lumen Output (lm)	Color Temp. (K)	Lamp Dimension (mm)		Lamp Current (A)	Base Cap	HSN Code	MRP Rs. Per Unit (incl. of all taxes)	Master Packing (No. of Unit/s)
				Length	Dia.					
Adore Jumbo LED 26 W B22 CDL Lamp	LHLDEUEEML8R026	2600	6500 K	185	100	0.130 A	B22	85395200	650.00	6 N
Adore Jumbo LED 30 W B22 CDL Lamp	LHLDEUEEML8R030	3000	6500 K	185	100	0.150 A	B22	85395200	750.00	6 N
Adore Jumbo LED 40 W B22 CDL Lamp	LHLDEUEEML8R040	4000	6500 K	190	120	0.20 A	B22	85395200	1050.00	6 N
Adore Jumbo LED 50 W B22 CDL Lamp	LHLDEUEEML8R050	5000	6500 K	220	140	0.250 A	B22	85395200	1350.00	6 N
Adore Jumbo LED 26 W B22 WW Lamp	LHLDEUEEMD8R026	2340	3000 K	185	100	0.130 A	B22	85395200	650.00	6 N
Adore Jumbo LED 30 W B22 WW Lamp	LHLDEUEEMD8R030	2700	3000 K	185	100	0.150 A	B22	85395200	750.00	6 N
Adore Jumbo LED 40 W B22 WW Lamp	LHLDEUEEMD8R040	2700	3000 K	190	120	0.20 A	B22	85395200	1050.00	6 N
Adore Jumbo LED 50 W B22 WW Lamp	LHLDEUEEMD8R050	4500	3000 K	220	140	0.250 A	B22	85395200	1350.00	6 N

FLORID ULTRA LED

FLORID ULTRA CANOPY



Description	Ordering Code	Lumen Output (lm)	Color Temp. (K)	Lamp Dimension (mm)		Lamp Current (A)	Base Cap	HSN Code	MRP Rs. Per Unit (incl. of all taxes)	Master Packing (No. of Unit/s)
				Length	Dia.					
LED Florid Ultra 30 W B22 865 Lamp	LHLDEIEDML8X030	3150	6500 K	129	150	0.14 A	B22	85395200	750.00	8 N
LED Florid Ultra 40 W B22 865 Lamp	LHLDEIEDML8X040	4200	6500 K	147	180	0.185 A	B22	85395200	1050.00	8 N
LED Florid Ultra 50 W B22 865 Lamp	LHLDEIEDML84050	5250	6500 K	147	180	0.235 A	B22	85395200	1275.00	8 N

LED Lamps

FILAMENT LED LAMPS

BRIGHTFILL FILAMENT LED (CLEAR AND AMBER)



Description	Ordering Code	Lumen Output (lm)	Color Temp. (K)	Lamp Dimension (mm)		Lamp Current (A)	Base Cap	HSN Code	MRP Rs. Per Unit (incl. of all taxes)	Master Packing (No. of Unit/s)
				Length	Dia.					
LED Filament lamp 4 W T32 2C Type B22 CLEAR	LHLDANEC3C8O004	450	2700 K	185	32	0.020 A	B22	85395200	600.00	24 N
LED Filament lamp 4 W T32 2C Type E27 CLEAR	LHLDANHC3C8O004	450	2700 K	185	32	0.020 A	E27	85395200	600.00	24 N
LED Filament lamp 4 W T32 2C Type B22 AMBER	LHLDANEG3B8O004	450	2500 K	185	32	0.020 A	B22	85395200	600.00	24 N
LED Filament lamp 4 W T32 2C Type E27 AMBER	LHLDANHG3B8O004	450	2500 K	185	32	0.020 A	E27	85395200	600.00	24 N
LED Filament lamp 4 W T32 6C Type B22 CLEAR	LHLDAOEC3C8O004	450	2700 K	105	32	0.020 A	B22	85395200	500.00	24 N
LED Filament lamp 4 W T32 6C Type E27 CLEAR	LHLDAOHC3C8O004	450	2700 K	105	32	0.020 A	E27	85395200	500.00	24 N
LED Filament lamp 4 W T32 6C Type B22 AMBER	LHLDAOEG3B8O004	450	2500 K	105	32	0.020 A	B22	85395200	500.00	24 N
LED Filament lamp 4 W T32 6C Type E27 AMBER	LHLDAOHG3B8O004	450	2500 K	105	32	0.020 A	E27	85395200	500.00	24 N
LED Filament lamp 5 W C35 Type E14 AMBER	LHLDACOG3B8O005	450	2500 K	98	35	0.042 A	E14	85395200	225.00	24 N
LED Filament lamp 7.5 W A60 Type B22 AMBER	LHLDADHG3B8O7X5	750	2500 K	104	60	0.036 A	B22	85395200	400.00	24 N
LED Filament lamp 7.5 W A60 Type E27 AMBER	LHLDADHG3B8O7X5	750	2500 K	104	60	0.036 A	E27	85395200	400.00	24 N
LED Filament lamp 7.5 W ST64 Type B22 CLEAR	LHLDAAHC3C8O7X5	750	2700 K	140	64	0.036 A	B22	85395200	425.00	24 N
LED Filament lamp 7.5 W ST64 Type E27 CLEAR	LHLDAAHC3C8O7X5	750	2700 K	140	64	0.036 A	E27	85395200	425.00	24 N
LED Filament lamp 7.5 W ST64 Type B22 AMBER	LHLDAAHG3B8O7X5	750	2500 K	140	64	0.036 A	B22	85395200	425.00	24 N
LED Filament lamp 7.5 W ST64 Type E27 AMBER	LHLDAAHG3B8O7X5	750	2500 K	140	64	0.036 A	E27	85395200	425.00	24 N
LED Filament lamp 7.5 W G95 Type B22 CLEAR	LHLDAAEC3C8O7X5	750	2700 K	140	95	0.036 A	B22	85395200	500.00	12 N
LED Filament lamp 7.5 W G95 Type E27 CLEAR	LHLDAAHC3C8O7X5	750	2700 K	140	95	0.036 A	E27	85395200	500.00	12 N
LED Filament lamp 7.5 W G95 Type B22 AMBER	LHLDAAEG3C8O7X5	750	2500 K	140	95	0.036 A	B22	85395200	500.00	12 N
LED Filament lamp 7.5 W G95 Type E27 AMBER	LHLDAAHG3C8O7X5	750	2500 K	140	95	0.036 A	E27	85395200	500.00	12 N
LED Filament lamp 7.5 W G125 Type B22 CLEAR	LHLDAAEC3C8O7X5	750	2700 K	178	125	0.036 A	B22	85395200	600.00	12 N
LED Filament lamp 7.5 W G125 Type E27 CLEAR	LHLDAAHC3C8O7X5	750	2700 K	178	125	0.036 A	E27	85395200	600.00	12 N
LED Filament lamp 7.5 W G125 Type B22 AMBER	LHLDAAEG3B8O7X5	750	2500 K	178	125	0.036 A	B22	85395200	600.00	12 N
LED Filament lamp 7.5 W G125 Type E27 AMBER	LHLDAAHG3B8O7X5	750	2500 K	178	125	0.036 A	E27	85395200	600.00	12 N



Portable Lighting

Today everything around us resonates technology and people are upgrading to wireless lifestyle. Hence, there is a constant desire for products which are portable and adds convenience in our day-to-day living. Hence, continuing with its innovative and technologically advanced products in FMEG segment, Havells has launched its new range of Rechargeable Lantern and Torches that comes with the best in class LED and advanced battery life to provide impressive light output and durability on a single charge.

Now, go wherever you want to with an aura of your own!

PATHFINDER 5

Aesthetically designed compact 0.5 W Rechargeable LED torch in Red & Orange Color.

Ordering Code	Color	Watt	Battery Type	Battery Capacity	HSN Code	MRP Rs. Per Unit (incl. of all taxes)	Master Packing (No. of Unit/s)
LHETAPFCBN1R0X5	Red	0.5 W	Rechargeable	4 V, 400 mAh	85131010	210.00	10 N
LHETAPFCBN1N0X5	Orange	0.5 W	Rechargeable	4 V, 400 mAh	85131010	210.00	10 N



PATHFINDER 10

Aesthetically designed compact 1 W Rechargeable LED torch in Blue & Yellow Color.

Ordering Code	Color	Watt	Battery Type	Battery Capacity	HSN Code	MRP Rs. Per Unit (incl. of all taxes)	Master Packing (No. of Unit/s)
LHETBPFCAN1B001	Blue	1 W	Rechargeable	4 V, 400 mAh	85131010	260.00	10 N
LHETBPFCAN1Y001	Yellow	1 W	Rechargeable	4 V, 400 mAh	85131010	260.00	10 N



PATHFINDER 30

Aesthetically designed 3 W Rechargeable LED torch.

Ordering Code	Watt	Battery Type	Battery Capacity	HSN Code	MRP Rs. Per Unit (incl. of all taxes)	Master Packing (No. of Unit/s)
LHETCPFCAN1A003	3 W	Rechargeable	4 V, 900 mAh	85131010	350.00	10 N



SPARKLINE MINI

Aesthetically designed compact 0.5 W 2 N × AA Dry cell LED torch.

Ordering Code	Color	Watt	Battery Type	Battery Capacity	HSN Code	MRP Rs. Per Unit (incl. of all taxes)	Master Packing (No. of Unit/s)
LHEXTAPGTN1B0X5	Red Yellow Blue	0.5 W	Dry Cell	2 N × AA	85131010	85.00	30 N



SPARKLINE

Aesthetically designed compact 0.5 W 3 N × AA Dry cell LED torch.

Ordering Code	Color	Watt	Battery Type	Battery Capacity	HSN Code	MRP Rs. Per Unit (incl. of all taxes)	Master Packing (No. of Unit/s)
LHEXTAPGTN1Y0X5	Red Yellow Blue	0.5 W	Dry Cell	3 N × AA	85131010	110.00	30 N



Consumer Luminaires

PORTABLE LIGHTING

GLOW 30

3 W dry cell torch powered by 3XAA dry batteries with housing made of complete radium which glows in dark.

Ordering Code	Color	Watt	Battery Type	Battery Capacity	HSN Code	MRP Rs. Per Unit (incl. of all taxes)	Master Packing (No. of Unit/s)
LHEXAUPGTNNW003	Radium Glow	3 W	Dry Cell	3 N × AA	85131010	250.00	30 N



RANGER 10/30

Ergonomically designed 1 W & 3 W LED torches for comfortable handling.

Ordering Code	Watt	Battery Type	Battery Capacity	HSN Code	MRP Rs. Per Unit (incl. of all taxes)	Master Packing (No. of Unit/s)
LHEXAOPFUN1K001	1 W	Rechargeable	4 V, 400 mAh	85131010	280.00	10 N
LHEXAOPFUN1K003	3 W	Rechargeable	4 V, 900 mAh	85131010	390.00	10 N



BEEMER NXT

5 W rechargeable torch with side light and Lithium ion battery for faster charging.

Ordering Code	Color	Watt	Battery Type	Battery Capacity	HSN Code	MRP Rs. Per Unit (incl. of all taxes)	Master Packing (No. of Unit/s)
LHEXTGP1CN1G005	Green	5 W	Rechargeable Li-ion	3.7 V, 4000 mAh	85131010	1300.00	10 N



BEAM 10 MINI

1 W pocket sized bright rechargeable torch with side light and Lithium ion battery for faster charging.

Ordering Code	Color	Watt	Battery Type	Battery Capacity	HSN Code	MRP Rs. Per Unit (incl. of all taxes)	Master Packing (No. of Unit/s)
LHEXTFP7CN1K001	Black	1 W	Rechargeable Li-ion	3.7 V, 1200 mAh	85131010	365.00	10 N



BEAM 10/30

1 W/3 W bright rechargeable torch with Lithium ion battery for faster charging.

Ordering Code	Color	Watt	Battery Type	Battery Capacity	HSN Code	MRP Rs. Per Unit (incl. of all taxes)	Master Packing (No. of Unit/s)
LHEXAUPGBNNK001	Black	1 W	Rechargeable Li-ion	3.7 V, 1200 mAh	85131010	395.00	10 N
LHEXAUPGBNNK003	Black	3 W	Rechargeable Li-ion	3.7 V, 1200 mAh	85131010	495.00	10 N



TREKBAND

3 W rechargeable head torch with flexible headband and adjustable neck for better direction to light.

Ordering Code	Watt	Battery Type	Battery Capacity	HSN Code	MRP Rs. Per Unit (incl. of all taxes)	Master Packing (No. of Unit/s)
LHEXAJPGENNK003	3 W	Rechargeable Li-ion	3.7 V, 1200 mAh	85131010	600.00	10 N



OUTRIDER

10 W rechargeable torch with side light with long range and high brightness.

Ordering Code	Watt	Battery Type	Battery Capacity	HSN Code	MRP Rs. Per Unit (incl. of all taxes)	Master Packing (No. of Unit/s)
LHEXTDPGEN1K010	10 W	Rechargeable Li-ion	3.7 V, 1800 mAh	85131010	1550.00	6 N



BEEMER 50

5 W LED torch with high intensity focused beam with twin switching mode.

Ordering Code	Watt	Battery Type	Battery Capacity	HSN Code	MRP Rs. Per Unit (incl. of all taxes)	Master Packing (No. of Unit/s)
LHEXAOPFUN1G005	5 W	Rechargeable Li-ion	3.7 V, 3000 mAh	85131010	1200.00	6 N



DAZZLE PLUS SOLAR 2 IN 1

5 W LED Lantern cum Torch with Twin Charging mode – 5 V Charging Cable or Integrated Solar Panel.

Ordering Code	Watt	Battery Type	Battery Capacity	HSN Code	MRP Rs. Per Unit (incl. of all taxes)	Master Packing (No. of Unit/s)
LHEXTDP7HN1G005	5 W	Rechargeable Li-ion	3.7 V, 2000 mAh	94054100	1600.00	6 N



GLANZ SOLAR

Compact design, 1.5 W solar rechargeable torch in red finish.

Ordering Code	Watt	Battery Type	Battery Capacity	HSN Code	MRP Rs. Per Unit (incl. of all taxes)	Master Packing (No. of Unit/s)
LHEXTEPWFN1K1X5	1.5 W	Rechargeable	4 V, 1600 mAh	94054100	430.00	10 N



Consumer Luminaires

PORTABLE LIGHTING

GLANZ SOLAR PLUS

Compact design, 3 W solar rechargeable lantern cum torch in red finish.

Ordering Code	Watt	Battery Type	Battery Capacity	HSN Code	MRP Rs. Per Unit (incl. of all taxes)	Master Packing (No. of Unit/s)
LHEXTEPWFN1R003	3 W	Rechargeable	4 V, 1600 mAh	94054100	550.00	10 N



SOLIS

Compact design, 2.8 W LED lantern with smooth dimming operation and inbuilt camping hook.

Ordering Code	Watt	Battery Type	Battery Capacity	HSN Code	MRP Rs. Per Unit (incl. of all taxes)	Master Packing (No. of Unit/s)
LHEXTEP7MN1M2X8	2.8 W	Rechargeable Li-ion	3.7 V, 1500 mAh	85131010	1150.00	6 N



RAYLINE NEO

Rechargeable 6 W LED light with frosted PC cover and pull chord.

Ordering Code	Watt	Battery Type	Battery Capacity	HSN Code	MRP Rs. Per Unit (incl. of all taxes)	Master Packing (No. of Unit/s)
LHEXTEP7CN1W006	6 W	Rechargeable Li-ion	3.7 V, 1800 mAh	85131010	1200.00	10 N



LUMINA NEO SOLAR LANTERN

Aesthetically designed Rechargeable LED Lantern with smooth dimming regulator.

Ordering Code	Color	Watt	Battery Type	Battery Capacity	HSN Code	MRP Rs. Per Unit (incl. of all taxes)	Master Packing (No. of Unit/s)
LHEXBQP7TN1R3X6	Red	3.6 W	Rechargeable Li-ion	3.7 V, 1200 mAh	94054100	1400.00	6 N



BEEMER PLUS

3 W rechargeable torch with two brightness modes and in-built solar panel.

Ordering Code	Watt	Battery Type	Battery Capacity	HSN Code	MRP Rs. Per Unit (incl. of all taxes)	Master Packing (No. of Unit/s)
LHEXTFP7EN1K003	3 W	Rechargeable Li-ion	3.7 V, 1800 mAh	94054100	1150.00	6 N



BEEMER PRO

3 W rechargeable torch with side light and inbuilt solar panel.

Ordering Code	Watt	Battery Type	Battery Capacity	HSN Code	MRP Rs. Per Unit (incl. of all taxes)	Master Packing (No. of Unit/s)
LHEXTFP7FN1K003	3 W	Rechargeable Li-ion	3.7 V, 1800 mAh	94054100	1250.00	6 N



GALAXY NEO LANTERN

Aesthetically designed rechargeable LED Lantern with long backup time.

Ordering Code	Color	Watt	Battery Type	Battery Capacity	HSN Code	MRP Rs. Per Unit (incl. of all taxes)	Master Packing (No. of Unit/s)
LHEXTEP7HN1R003	Red	3 W	Rechargeable Li-ion	3.7 V, 2000 mAh	85131010	1600.00	6 N



MODERNA 3 IN 1 RECHARGEABLE LIGHT

3 CCT changing and dimming 4.5 W sleek and portable LED Table Lamp.

Ordering Code	Watt	Battery Type	Battery Capacity	HSN Code	MRP Rs. Per Unit (incl. of all taxes)	Master Packing (No. of Unit/s)
LHEXBZPNFN1W4X5	4.5 W	Rechargeable	4 V, 2000 mAh	85131010	1800.00	12 N



MODERNA DESKTOP RECHARGEABLE LIGHT

4 W sleek and portable LED table lamp with multifunctional base.

Ordering Code	Watt	Battery Type	Battery Capacity	HSN Code	MRP Rs. Per Unit (incl. of all taxes)	Master Packing (No. of Unit/s)
LHEXBZP7CN1W004	4 W	Rechargeable	4 V, 1200 mAh	85131010	1400.00	8 N



MODERNA CLIP-ON RECHARGEABLE LIGHT

4 W sleek and portable LED table lamp with clip style mounting base.

Ordering Code	Watt	Battery Type	Battery Capacity	HSN Code	MRP Rs. Per Unit (incl. of all taxes)	Master Packing (No. of Unit/s)
LHEXBZP7BN1W004	4 W	Rechargeable	4 V, 1200 mAh	85131010	1200.00	8 N



Consumer Luminaires

PORTABLE LIGHTING

DISINFECTMAX LED UVC STERILIZER

2 W sleek and portable UVC LED Sanitizer with Auto timer and Gravity sensor.

Ordering Code	Watt	Battery Type	Battery Capacity	HSN Code	MRP Rs. Per Unit (incl. of all taxes)	Master Packing (No. of Unit/s)
LHEXAUPNBNNW002	2 W	Rechargeable Li-ion	3.7 V, 500 mAh	85131010	2900.00	6 N





TERMS & CONDITION

- Prices are in Indian ₹ (Inclusive of GST).
- All prices of luminaires included in the list price are without lamp / tube, except wherever specified.
- Warranty applicable as per Havells warranty policy.
- Prices are subject to change without notice.
- All prices are subject to Havells general terms and conditions of business.
- This list price / price list supercedes all previous price lists.
- Every effort has been made to ensure accuracy in compilation of technical / commercial detail within this publication.
- Specification and performance data are constantly changing; current details should, therefore, be checked with the company.
- Company reserves the right to issue amendments, which may arise due to any errors in the price list.
- All MRP Rs. (inclusive of all taxes) / List Price mentioned above are for quantity 1 N

Although every effort has been made to ensure accuracy in the compilation of the technical detail within this publication, however current details should therefore be checked with Havells. Specifications and performance data are constantly changing. Copyright Subsists. Imitation of trade dress, graphics and color scheme of this document is a punishable offence.

REGIONAL & BRANCH OFFICES:

NORTH - REGIONAL OFFICE: Corporate Office: QRG Towers, 2D, Sector-126, Expressway, Noida-201304, Tel: 0120-3331000, **Delhi:** Tel: 011-47676700, 23888200, **Chandigarh:** Tel: 0172-4232400-401, **Dehradun:** Tel: 0135-6670202, **Haldwani:** Tel: 05946-222935/222933, **Noida/Haryana:** Tel: 0120-3331000, **Ludhiana:** Tel: 0161-4676000/24, **Amritsar:** Tel: 0183-5202400/401, **Jammu:** Tel: 0191-2478330, 2479330, **Sri Nagar:** Tel: 0194-2490431, **Jaipur:** Tel: 0141-3914645, 3988210, **Jodhpur:** Tel: 0291-9214201640 / 45, **Lucknow:** Tel: 0522-6672100, **Kanpur:** Tel: 0512-6710400, 6710409

EAST - REGIONAL OFFICE: Kolkata: ICC Tower, 5th Floor, 4 India Exchange Place, Kolkata-700001, Tel: 033-40129851 / 52, **Bhubaneshwar:** Tel: 0674-6668101/102/103/104, **Guwahati:** Tel: 0361-2134521, 2458923, 2460355, **Siliguri:** Tel: 0353-2525907, **Ranchi:** Tel: 0651-2244861, 2244862, 2244864, 2244868, 2244869, **Jamshedpur:** Tel: 0657-6542492, 09234369436, **Patna:** Tel: 0612-2207221, 2207222, 2207223, 2655518

WEST - REGIONAL OFFICE: Mumbai: 14th Floor, Unit No. 1405- 1408, Lodha Supremus, I- Think Techno Campus, Kanjurmarg East, Mumbai- 400 042. Tel: 022 - 67298600-601, **Ahmedabad:** Tel: 079-40061111, 40060738-740, **Indore:** Tel: 0731-2572340-41, 4009998 (Airtel), **Rajkot:** Tel: 0281-2481112, 2921212, **Nagpur:** Tel: 0712-2240932, 2242692, 2242699, **Pune:** Tel: 020-64016413/14, **Raipur:** Tel: 0771-4243400/01, **Surat:** Tel: 0261-2350137, 9979890137, **Jabalpur:** Tel: 0761-4064491, **Bhopal:** 0755-4271544, 0755-4011025

SOUTH - REGIONAL OFFICE: Chennai: Khivraj Complex -1, 1st Floor No.480, Annasalai, Nandanam, Chennai – 600035 Tel: 044-42280600 / 605, **Bangalore:** Tel: 080-49075000, **Coimbatore:** Tel: 0422- 4550200 / 287, **Hyderabad:** Tel: 040-27533372, 27533355, 27533632, 66320407/0408/6401/6402, **Cochin:** Tel: 0484-4099000, **Calicut:** Tel: 0495-4019194, **Trivandrum:** Tel: 0471-4015323, **Vizag:** Tel: 0891-6514339, **Vijayawada:** Tel: +91-9247058847/57, **Hubli:** 09448146028

Representative Offices: • Goa • Solapur • Gwalior • Kathmandu • Kolhapur • Vadodara

Scan the QR Code
to download
Havells mCatalogue



Havells India Ltd.

QRG Towers, 2D, Sector -126, Expressway, Noida - 201 304 (UP), Ph. +91-120-3331000,
E-mail: marketing@havells.com, www.havells.com
Customer Care No. 08045 77 1313
Join us on Facebook at www.facebook.com/havells and share your ways to save the planet!
CIN - L31900DL1983PLC016304.



Get in Touch with Us

Contact Us:

Mr. Laxmikant Laddha: 09822332340

Giriraj Laddha: 09881245431

Rahul Laddha: 09881245432

 sales@rajelectricals.co.in

 <https://rajelectricals.co.in/>



Lighting Store:

583, Narayan Peth, Jaldhara Society,
Near Kanyashala, Pune-411030

Phone: (020) 24455293, 24461156,
24481583, 24486306, 24492424



Electrical Store:

353/2, Shaniwar Peth, Ramanbaug
Co-operative Hsg Society, Near
Ramanbaug School, Pune-411030.

Phone: 098812 45432



[rajelectricalspune](https://www.facebook.com/rajelectricalspune)



[raj__electricals](https://www.instagram.com/raj__electricals)