

# Legero

## The future through our lenses

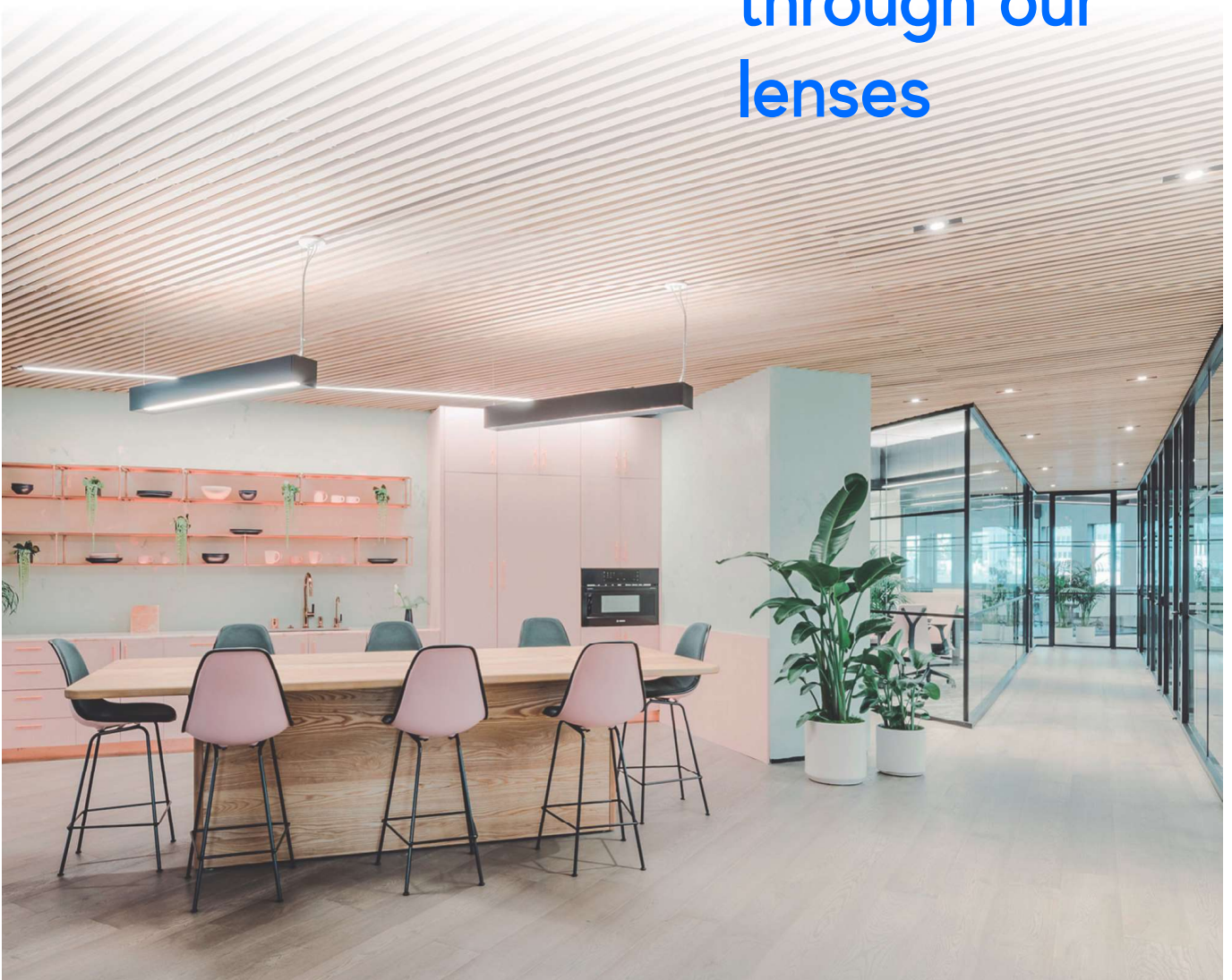

Architectural Luminaires  
Decorative Luminaires  
Industrial Luminaires  
Outdoor Luminaires

Architectural Catalogue  
January 2020

[legerolighting.com](http://legerolighting.com)

**We are a lighting solutions company.  
While at the same time, we are more than that.**

# LegeroLighting

Like everything in nature is constantly evolving, we as a Lights manufacturing company too are evolving incessantly.

With over a decade of experience alongside the extremely creative and dynamic teams both internally and externally, we have now developed a clear understanding of what it means to provide lighting solutions.

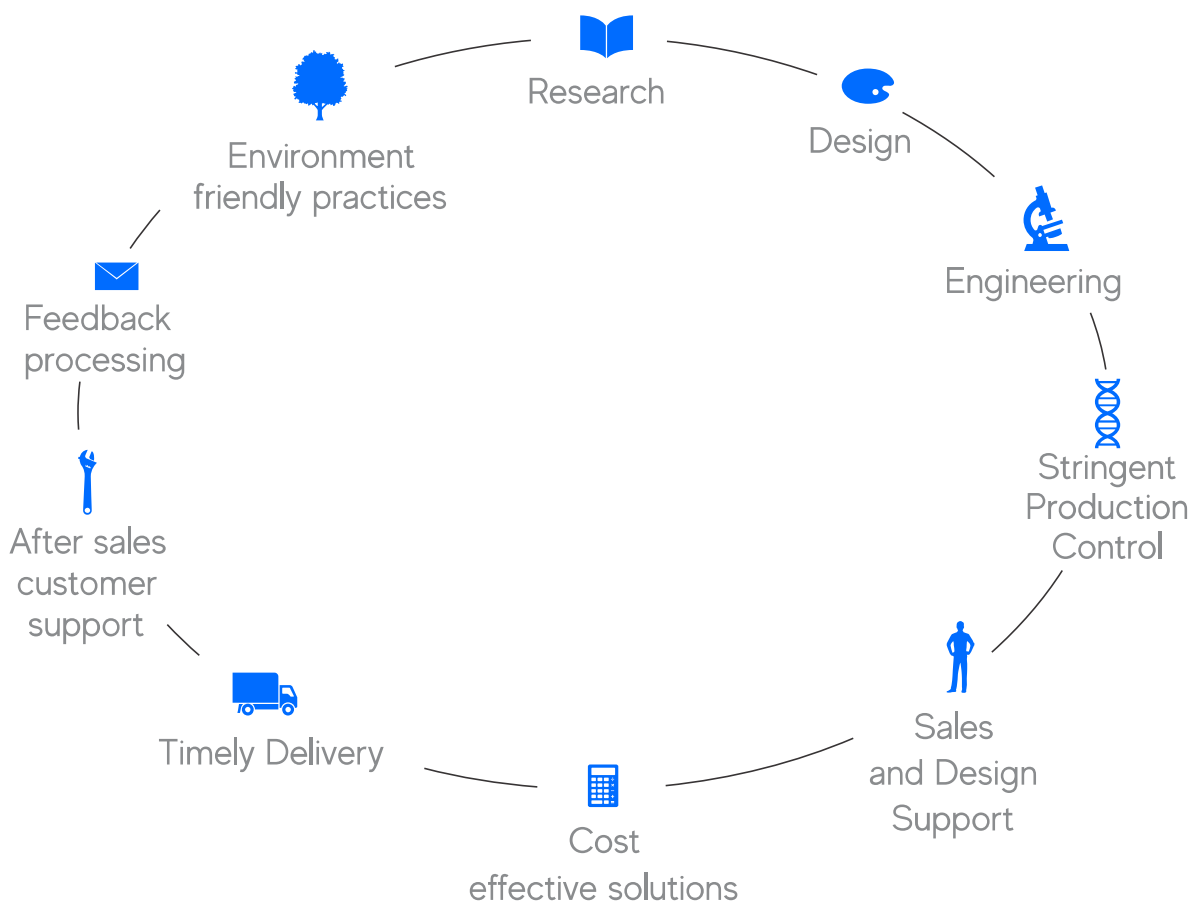

Our focus is to provide a large range of standard and custom-made solutions to meet the need of distinctive projects.

If it has been designed or even imagined, we aim to create the solutions and ensure it has served the space in the best way possible.

Simply put, we are just not a catalogue of products, we are your extended team striving to achieve perfection in every project.

**Made In India**



## **Brighten up spaces**

Our solutions have lit up offices, industrial and commercial spaces, outdoors and consumer areas. We are constantly looking at ways to improve the end users' quality of life, and not just meet, but exceed our customers' expectations.

## **Our products:**

Resessed Downlights  
Surface & Suspended Downlights  
Surface Mounted Luminaires  
Recessed Luminaires  
Surface & Suspended Luminaires  
Architectural Luminaires  
Decorative Luminaires  
Industrial Luminaires  
Outdoor Luminaires



## Sonic

Sonic a perfect suspended luminaire design with step in optics offering a combination of functionality and design. A linear lens combination gives a unique look to this product. A aesthetically pleasant product suitable in various applications like offices, restaurants, Showrooms etc.



## Features

- Aesthetically elegant & functional design.
- Improved efficiency.
- Uniform Light Distribution.
- Save upto 80% of Energy.
- Better glare control.



**4X** Energy Saving Efficiency



Available in 3 colors

## General information

Shape	Mounting type	Finish	IP Rating	Housing	Diffuser - Reflector	Lamp type	Driver type	Electrical class
Rectangular	Suspended	Powder Coated	IP 20	Extruded Aluminium	Modular Lens	LED	HPF Isolated	II

## Technical specifications

Product code	Input voltage range	Input frequency	Operating temp. range	CCT	Lamp life expectancy at L70	CRI	Rated wattage efficacy (lm/W)	Surge Protection	Power factor	ITHD (%)	Beam angle
LPS 5025 - LPS 5040	100V-300V	50Hz	-10°C to +40°C	3000K 4000K 6000K	50Khrs	>80	90/95/100	4 kV	≥0.95	<10%	70°

## Product dimensions

Wattage    Length (l)    Breadth (b)    Depth (h) All dimensions in mm

25W-40W    1177    57.7    85.6

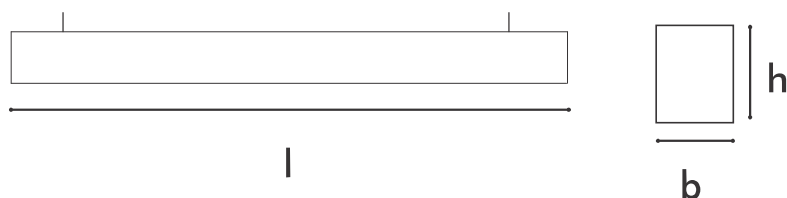



## Verge 5

The suspended aluminium extrusion with continuous reflectors optics that offers improved efficiency with focus on reduced UGR. Various customisation available with prismatic lens in cell louvers gives flexible light option to the product.

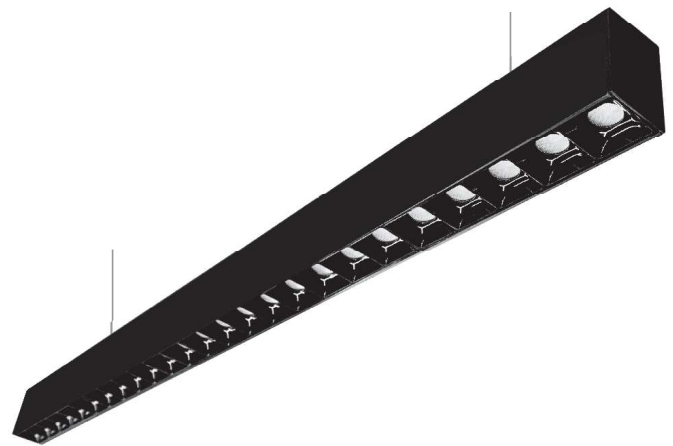

### Features

- Aesthetically elegant & functional design.
- Improved efficiency.
- Uniform Light Distribution.
- Save upto 80% of Energy.
- Cocentrated Beam Angle.



**4X** Energy Saving Efficiency



Available in 3 colors

## General information

Shape	Mounting type	Finish	IP Rating	Housing	Diffuser - Reflector	Lamp type	Driver type	Electrical class
Rectangular	Suspended	Powder Coated	IP 20	Extruded Aluminium	Reflector/ Clear PC Sheet	LED	HPF Isolated	II

## Technical specifications

Product code	Input voltage range	Input frequency	Operating temp. range	CCT	Lamp life expectancy at L70	CRI	Rated wattage efficacy (lm/W)	Surge Protection	Power factor	ITHD (%)	Beam angle
LVP 5130	100V-300V	50Hz	-10°C to +40°C	3000K 4000K 6000K	50Khrs	>80	85/90/95	4 kV	≥0.95	<10%	35°

## Product dimensions

Wattage    Length (l)    Breadth (b)    Depth (h) All dimensions in mm

30W    1186    57.7    85.6

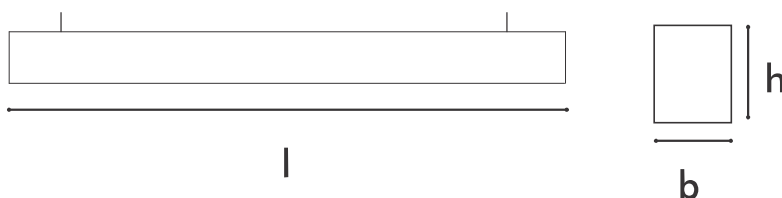



## Verge 3

The suspended aluminum extrusion with three reflectors module optics that offers improved efficiency with focus on reduced UGR. Various customisation available with prismatic lens in cell louvers gives flexible light option to the product.

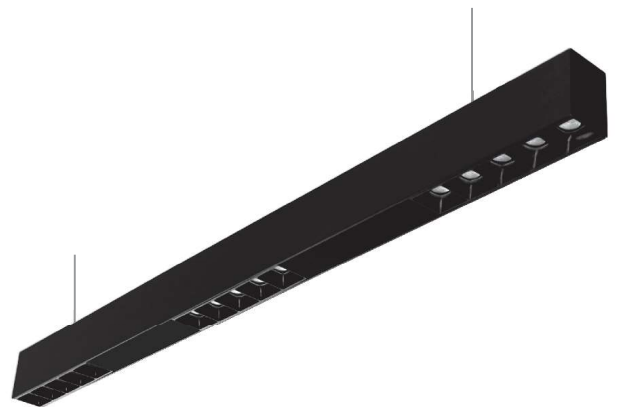

### Features

- Aesthetically elegant & functional design.
- Improved efficiency.
- Uniform Light Distribution.
- Save upto 80% of Energy.
- Cocentrated Beam Angle.



**4X** Energy Saving Efficiency



Available in 3 colors

## General information

Shape	Mounting type	Finish	IP Rating	Housing	Diffuser - Reflector	Lamp type	Driver type	Electrical class
Rectangular	Suspended	Powder Coated	IP 20	Extruded Aluminium	Reflector/ Clear PC Sheet	LED	HPF Isolated	II

## Technical specifications

Product code	Input voltage range	Input frequency	Operating temp. range	CCT	Lamp life expectancy at L70	CRI	Rated wattage efficacy (lm/W)	Surge Protection	Power factor	ITHD (%)	Beam angle
LVP 5230	100V-300V	50Hz	-10°C to +40°C	3000K 4000K 6000K	50Khrs	>80	80/85/90	4 kV	≥0.95	<10%	35°

## Product dimensions

Wattage    Length (l)    Breadth (b)    Depth (h) All dimensions in mm

30W    1215    57.7    85.6

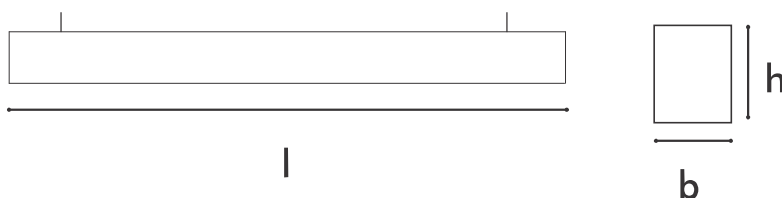



# Verge

The suspended aluminum extrusion having dual optics with three reflectors module & diffuser that offers improved efficiency with focus on reduced UGR. Various customisation available with prismatic lens in cell louvers and diffused slots gives flexible light option to the product.



## Features

- Aesthetically elegant & functional design.
- Improved efficiency.
- Uniform Light Distribution.
- Save upto 80% of Energy.
- Individual drivers for Diffused & Modular light.



**4X** Energy Saving Efficiency



Available in 3 colors

## General information

Shape	Mounting type	Finish	IP Rating	Housing	Diffuser - Reflector	Lamp type	Driver type	Electrical class
Rectangular	Suspended	Powder Coated	IP 20	Extruded Aluminium	Reflector/ Diffuser/ Clear PC Sheet	LED	HPF Isolated	II

## Technical specifications

Product code	Input voltage range	Input frequency	Operating temp. range	CCT	Lamp life expectancy at L70	CRI	Rated wattage efficacy (lm/W)	Surge Protection	Power factor	ITHD (%)	Beam angle
LVP 5340	100V-300V	50Hz	-10°C to +40°C	3000K 4000K 6000K	50Khrs	>80	75/80/85	4 kV	≥0.95	<10%	40°

## Product dimensions

Wattage    Length (l)    Breadth (b)    Depth (h) All dimensions in mm

40W    1215    57.7    85.6

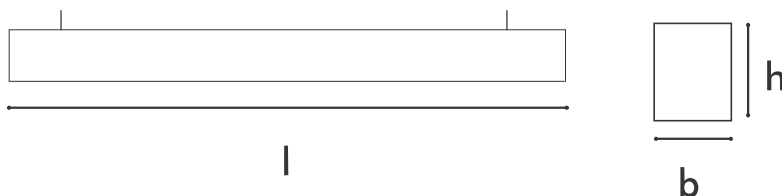



# Olive

A perfect combination of functionality and design, Olive is designed in an all rounder shape giving a clean aesthetic to a space. A newly designed suspended lighting is now on board, revealing a clean accessible revolutionary design perfectly blending in any space. The housing functions to support other components of the luminaire and provides a mounting mechanism for the attachment of the luminaire. The evolution in commercial lighting has been characterized by progress in all directions along with improvements in luminous performance and functional efficiency.



## Features

- Unique curved design.
- Functionally efficient.
- Extruded body for continuous installation
- HTF diffuser for improved efficiency.



**4X** Energy Saving Efficiency



Available in 3 colors

## General information

Shape	Mounting type	Finish	IP Rating	Housing	Diffuser - Reflector	Lamp type	Driver type	Electrical class
Round	Suspended	Powder Coated	IP 20	Extruded Aluminium	Diffuser	LED	HPF Isolated	II

## Technical specifications

Product code	Input voltage range	Input frequency	Operating temp. range	CCT	Lamp life expectancy at L70	CRI	Rated wattage efficacy (lm/W)	Surge Protection	Power factor	ITHD (%)	Beam angle
LSO 8520 - LSO 8530	100V-300V	50Hz	-10°C to +40°C	3000K 4000K 6000K	50Khrs	>80	95/100/105 - 85/90/95	4 kV	≥0.95	<10%	100°

Product code	High voltage cut off
--------------	----------------------

LSO 8520 - LSO 8530	≥310 ± 10Vac
---------------------------	--------------

## Product dimensions

Wattage	Length (l)	Breadth (b)	Depth (h)	All dimensions in mm			
---------	------------	-------------	-----------	----------------------	--	--	--

20W  
-  
30W

1200

ø87

79.3

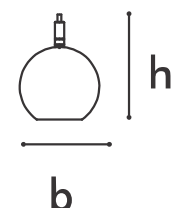
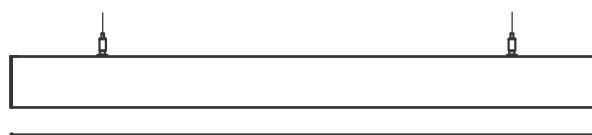



# Tulip

Tulip a suspended extruded aluminium housing design offers improved uniformity with soft C profile LG7 diffuser lit on all three sides offering a soft homogeneous, volumetric light distribution snap fit diffuser for ease in maintenance.

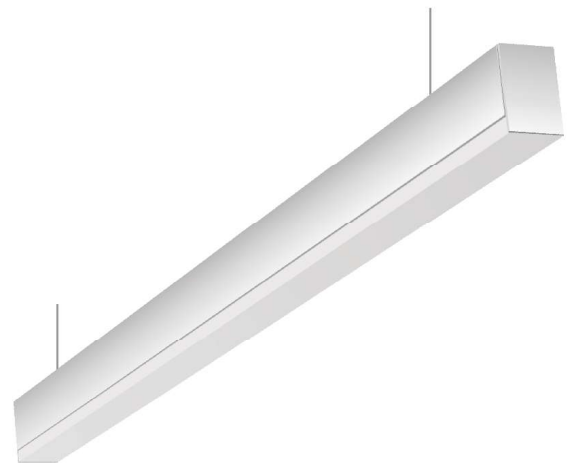

## Features

- Luminaire with three side fit diffuser.
- Improved Uniformity.
- Functionally efficient.
- Extruded body for continuous installation.



**4X** Energy Saving Efficiency



Available in 3 colors

## General information

Shape	Mounting type	Finish	IP Rating	Housing	Diffuser - Reflector	Lamp type	Driver type	Electrical class
Rectangular	Suspended/ Surface	Powder Coated	IP 20	Extruded Aluminium	Diffuser	LED	HPF Isolated	II

## Technical specifications

Product code	Input voltage range	Input frequency	Operating temp. range	CCT	Lamp life expectancy at L70	CRI	Rated wattage efficacy (lm/W)	Surge Protection	Power factor	ITHD (%)	Beam angle
LSO 5020 - LSO 5030	100V-300V	50Hz	-10°C to +40°C	3000K 4000K 6000K	50Khrs	>80	80/85/90 - 75/80/95	4 kV	≥0.95	<10%	120°

Product code	High voltage cut off
--------------	----------------------

LSO 5020 - LSO 5030	≥310 ± 10Vac
---------------------------	--------------

## Product dimensions

Wattage	Length (l)	Breadth (b)	Depth (h)	All dimensions in mm			
---------	------------	-------------	-----------	----------------------	--	--	--

20W - 30W	1200	50.5	75				
-----------------	------	------	----	--	--	--	--

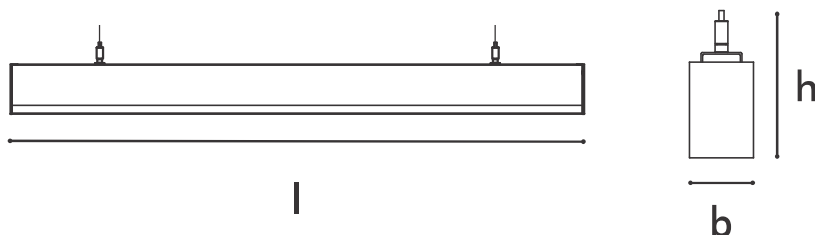



# Strapline 35S

The extruded aluminium housing offers a precise in-line appearance. This LED fixture comes with excellent light distribution, high wired electronic ballast to be used in suspended/surface applications.

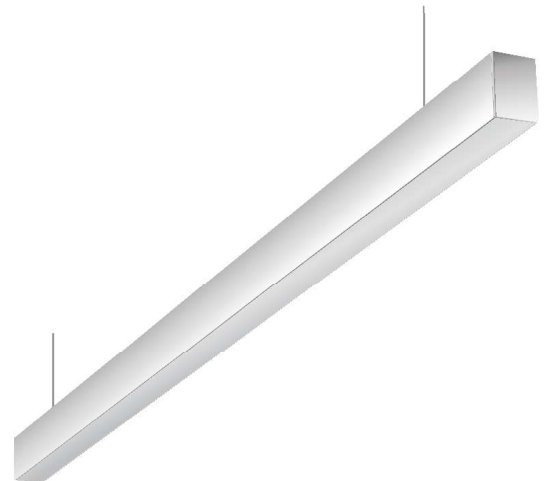

## Features

- Extruded aluminium housing.
- Snap fit diffuser for ease in maintaining.
- Improved efficiency
- Stand alone or continuous mounting option.
- Customizable to varied lengths.



**4X** Energy Saving Efficiency



Available in 3 colors

## General information

Shape	Mounting type	Finish	IP Rating	Housing	Diffuser - Reflector	Lamp type	Driver type	Electrical class
Rectangular	Surface/ Suspended	Powder Coated	IP 20	Extruded Aluminium	Diffuser	LED	HPF Non-Isolated	II

## Technical specifications

Product code	Input voltage range	Input frequency	Operating temp. range	CCT	Lamp life expectancy at L70	CRI	Rated wattage efficacy (lm/W)	Surge Protection	Power factor	ITHD (%)	Beam angle
LSL-S 3520 - LSL-S 3540	100V-300V	50Hz	-10°C to +40°C	3000K 4000K 6000K	50Khrs	>80	80/85/90	4 kV	≥0.95	<15%	110°

## Product dimensions

Wattage    Length (l)    Breadth (b)    Depth (h) All dimensions in mm

20W  
-  
40W

1200  
-  
2400

36.5

53

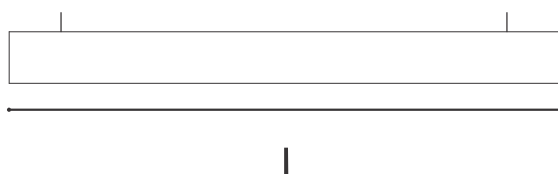



# Strapline 35R

The extruded aluminium housing offers a precise in-line appearance. This LED fixture comes with excellent light distribution, high wired electronic ballast and mounting clamps to be used in recessed application.



## Features

- Extruded aluminium housing.
- Snap fit diffuser for ease in maintaining.
- Improved efficiency
- Stand alone or continuous mounting option.
- Customizable to varied lengths.



**4X** Energy Saving Efficiency



Available in 3 colors

## General information

Shape	Mounting type	Finish	IP Rating	Housing	Diffuser - Reflector	Lamp type	Driver type	Electrical class
Rectangular	Recessed	Powder Coated	IP 20	Extruded Aluminium	Diffuser	LED	HPF Non-Isolated	II

## Technical specifications

Product code	Input voltage range	Input frequency	Operating temp. range	CCT	Lamp life expectancy at L70	CRI	Rated wattage efficacy (lm/W)	Surge Protection	Power factor	ITHD (%)	Beam angle
LSL-R 3520 - LSL-R 3540	100V-300V	50Hz	-10°C to +40°C	3000K 4000K 6000K	50Khrs	>80	80/85/90	4 kV	≥0.95	<15%	110°

## Product dimensions

Wattage    Length (l)    Breadth (b)    Depth (h) All dimensions in mm

20W  
-  
40W

1200  
-  
2400

46.5

57

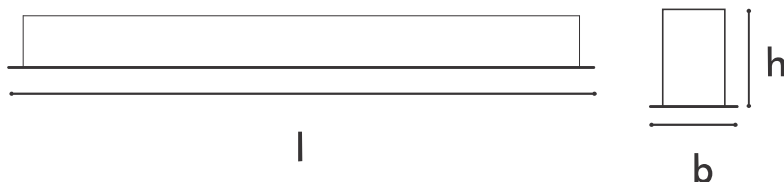



# Strapline 50 Up & Down

The extruded aluminium housing offers a precise in-line appearance. This LED fixture comes with Direct-Indirect light distribution, high wired electronic ballast to be used in suspended applications.

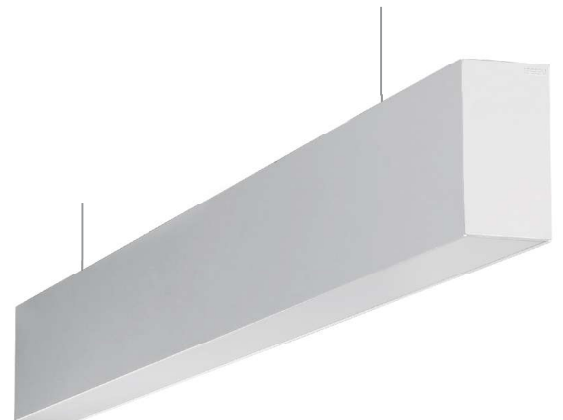

## Features

- Extruded aluminium housing.
- Direct/Indirect light distribution
- Snap fit diffuser for ease in installation.
- Improved efficiency.
- Stand alone or continuous mounting option.
- Customizable to varied lengths.



**4X** Energy Saving Efficiency



Available in 3 colors

## General information

Shape	Mounting type	Finish	IP Rating	Housing	Diffuser - Reflector	Lamp type	Driver type	Electrical class
Rectangular	Suspended	Powder Coated	IP 20	Extruded Aluminium	Diffuser	LED	HPF Isolated	II

## Technical specifications

Product code	Input voltage range	Input frequency	Operating temp. range	CCT	Lamp life expectancy at L70	CRI	Rated wattage efficacy (lm/W)	Surge Protection	Power factor	ITHD (%)	Beam angle
LSL-S 5130 - LSL-S 5140	100V-300V	50Hz	-10°C to +40°C	3000K 4000K 6000K	50Khrs	>80	80/85/90	4 kV	≥0.95	<10%	110°

Product code	High voltage cut off
--------------	----------------------

LSL-S 5130 - LSL-S 5140	≥310 ± 10Vac
-------------------------------	--------------

## Product dimensions

Wattage	Length (l)	Breadth (b)	Depth (h)	
---------	------------	-------------	-----------	--

All dimensions in mm

30W  
&  
40W

1200

52.8

101

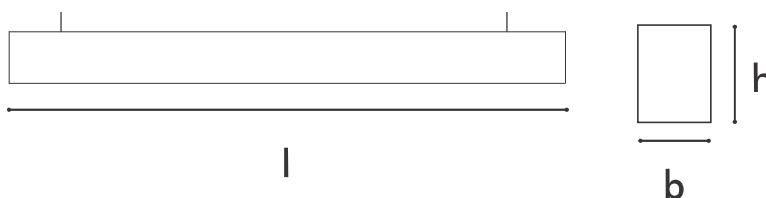

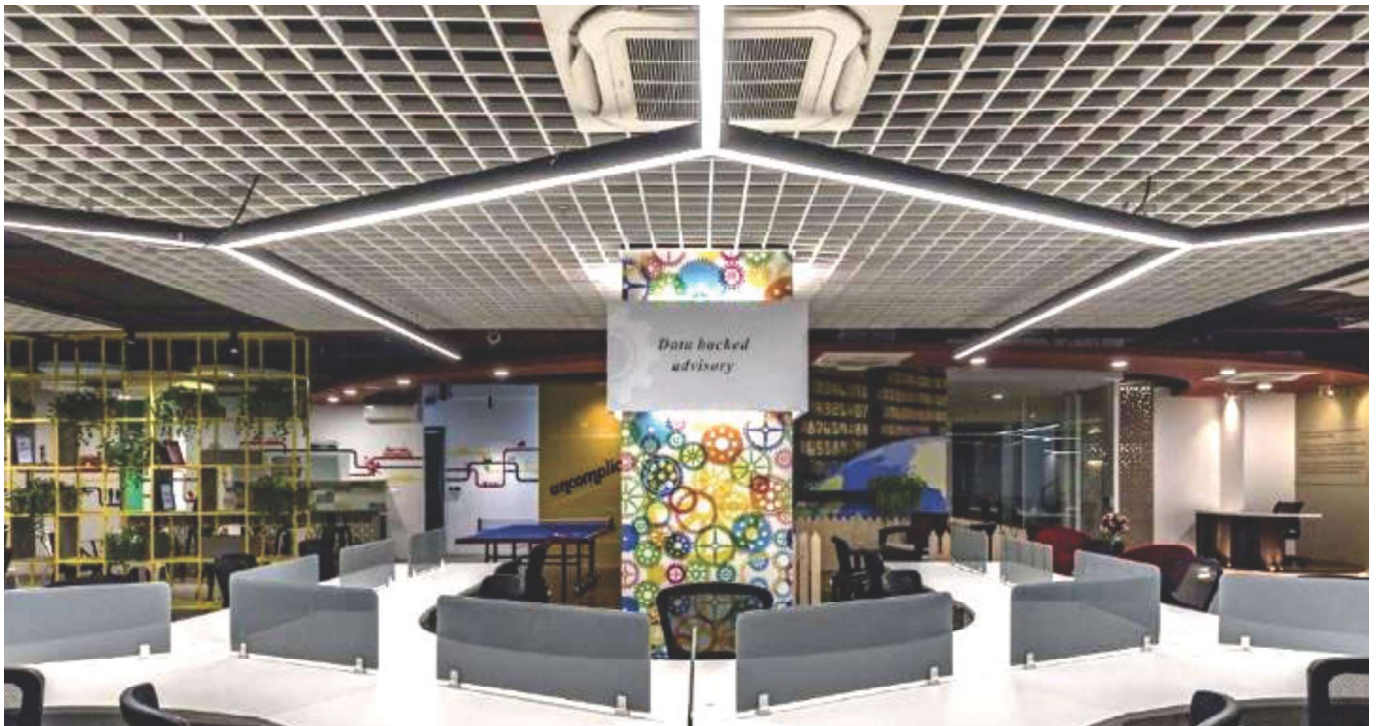

## Strapline 50S

The extruded aluminium housing offers a precise in-line appearance. This LED fixture comes with excellent light distribution, high wired electronic ballast to be used in suspended/surface applications.



### Features

- Extruded aluminium housing.
- Snap fit diffuser for ease in installation.
- Improved efficiency.
- Stand alone or continuous mounting option.
- Customizable to varied lengths.



**4X** Energy Saving Efficiency



Available in 3 colors

## General information

Shape	Mounting type	Finish	IP Rating	Housing	Diffuser - Reflector	Lamp type	Driver type	Electrical class
Rectangular	Surface/ Suspended	Powder Coated	IP 20	Extruded Aluminium	Diffuser	LED	HPF Isolated	II

## Technical specifications

Product code	Input voltage range	Input frequency	Operating temp. range	CCT	Lamp life expectancy at L70	CRI	Rated wattage efficacy (lm/W)	Surge Protection	Power factor	ITHD (%)	Beam angle
LSL-S 5020 - LSL-S 5030 - LSL-S 5040 - LSL-S 5060	100V-300V	50Hz	-10°C to +40°C	3000K 4000K 6000K	50Khrs	>80	90/95/100	4 kV	≥0.95	<10%	100°

Product code	High voltage cut off
LSL-S 5020 - LSL-S 5030 - LSL-S 5040 - LSL-S 5060	≥310 ± 10Vac

## Product dimensions

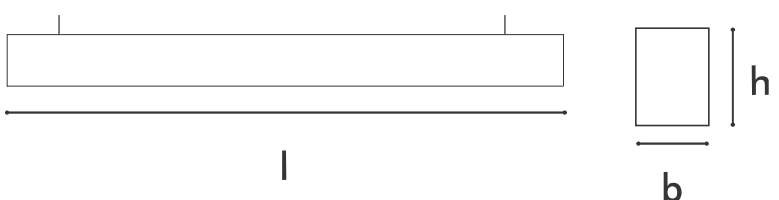
Wattage	Length (l)	Breadth (b)	Depth (h)	All dimensions in mm			
20W - 30W - 40W - 60W	1200 - 1200 - 2400 - 2400	53	80				



## Strapline 50R

The extruded aluminium housing offers a precise in-line appearance. This LED fixture comes with excellent light distribution, high wired electronic ballast and mounting clamps to be used in recessed application.



### Features

- Extruded aluminium housing.
- Snap fit diffuser for ease in maintaining.
- Improved efficiency.
- Stand alone or continuous mounting option.
- Customizable to varied lengths.



**4X** Energy Saving Efficiency



Available in 3 colors

## General information

Shape	Mounting type	Finish	IP Rating	Housing	Diffuser - Reflector	Lamp type	Driver type	Electrical class
Rectangular	Recessed	Powder Coated	IP 20	Extruded Aluminium	Diffuser	LED	HPF Isolated	II

## Technical specifications

Product code	Input voltage range	Input frequency	Operating temp. range	CCT	Lamp life expectancy at L70	CRI	Rated wattage efficacy (lm/W)	Surge Protection	Power factor	ITHD (%)	Beam angle
LSL-R 5020 - LSL-R 5030 - LSL-R 5040 - LSL-R 5060	100V-300V	50Hz	-10°C to +40°C	3000K 4000K 6000K	50Khrs	>80	90/95/100	4 kV	≥0.95	<10%	110°

Product code	High voltage cut off
LSL-R 5020 - LSL-R 5030 - LSL-R 5040 - LSL-R 5060	≥310 ± 10Vac

## Product dimensions

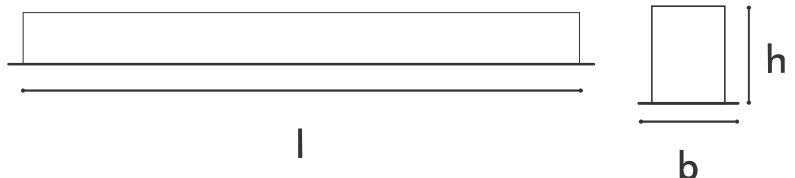
Wattage	Length (l)	Breadth (b)	Depth (h)	All dimensions in mm			
20W - 30W - 40W - 60W	1200 - 1200 - 2400 - 2400	63	80				



# Strapline 72S

The extruded aluminium housing offers a precise in-line appearance. This LED fixture comes with excellent light distribution, high wired electronic ballast to be used in suspended/surface applications.



## Features

- Extruded aluminium housing.
- Snap fit diffuser for ease in maintaining.
- Improved efficiency.
- Stand alone or continuous mounting option.
- Customizable to varied lengths.



**4X** Energy Saving Efficiency



Available in 3 colors

## General information

Shape	Mounting type	Finish	IP Rating	Housing	Diffuser - Reflector	Lamp type	Driver type	Electrical class
Rectangular	Surface/ Suspended	Powder Coated	IP 20	Extruded Aluminium	Diffuser	LED	HPF Isolated	II

## Technical specifications

Product code	Input voltage range	Input frequency	Operating temp. range	CCT	Lamp life expectancy at L70	CRI	Rated wattage efficacy (lm/W)	Surge Protection	Power factor	ITHD (%)	Beam angle
LSL-S 7220 - LSL-S 7230 - LSL-S 7240 - LSL-S 7260	100V-300V	50Hz	-10°C to +40°C	3000K 4000K 6000K	50Khrs	>80	80/85/90	4 kV	≥0.95	<10%	100°

Product code	High voltage cut off
LSL-S 7220 - LSL-S 7230 - LSL-S 7240 - LSL-S 7260	≥310 ± 10Vac

## Product dimensions

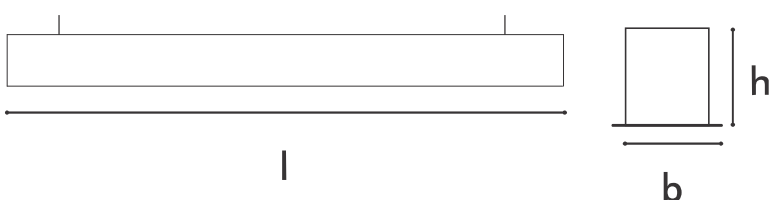
Wattage	Length (l)	Breadth (b)	Depth (h)	All dimensions in mm		
20W - 30W - 40W - 60W	1200 - 1200 - 2400 - 2400	73	78			



## Strapline 72R

The extruded aluminium housing offers a precise in-line appearance. This LED fixture comes with excellent light distribution, high wired electronic ballast and mounting clamps to be used in recessed application.



### Features

- Extruded aluminium housing.
- Snap fit diffuser for ease in maintaining.
- Improved efficiency.
- Stand alone or continuous mounting option.
- Customizable to varied lengths.



**4X** Energy Saving Efficiency



Available in 3 colors

## General information

Shape	Mounting type	Finish	IP Rating	Housing	Diffuser - Reflector	Lamp type	Driver type	Electrical class
Rectangular	Recessed	Powder Coated	IP 20	Extruded Aluminium	Diffuser	LED	HPF Isolated	II

## Technical specifications

Product code	Input voltage range	Input frequency	Operating temp. range	CCT	Lamp life expectancy at L70	CRI	Rated wattage efficacy (lm/W)	Surge Protection	Power factor	ITHD (%)	Beam angle
LSL-R 7220 - LSL-R 7230 - LSL-R 7240 - LSL-R 7250	100V-300V	50Hz	-10°C to +40°C	3000K 4000K 6000K	50Khrs	>80	80/85/90	4 kV	≥0.95	<10%	100°

Product code	High voltage cut off
LSL-R 7220 - LSL-R 7230 - LSL-R 7240 - LSL-R 7250	≥310 ± 10Vac

## Product dimensions

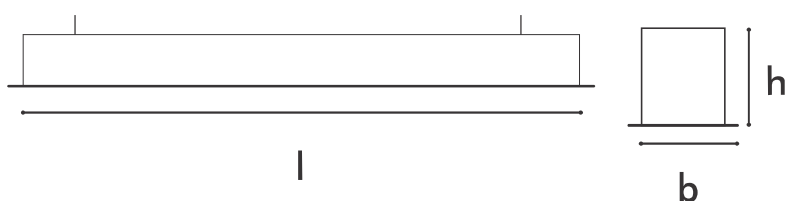
Wattage	Length (l)	Breadth (b)	Depth (h)	
20W - 30W - 40W - 60W	1200 - 1200 - 2400 - 2400	92	92	 <p>The diagram shows a perspective view of the rectangular light fixture. Dimension 'l' represents the length of the fixture, and dimension 'b' represents the breadth. The depth is indicated as 92 mm in the table above.</p>

All dimensions in mm



# Strapline T

Luminaires compatible with armstrong TECHZONE ceiling. Recessed single length individual luminaire, aluminium extruded natural anodised housing with matt finish extruded PMMA opal diffuser with uniform light distribution.



## Features

- Extruded aluminium housing.
- Compatible with Armstrong TECHZONE ceiling
- Improved efficiency.
- Glare free evenly distributed.
- Long Life Span.



**4X** Energy Saving Efficiency



Available in 3 colors

## General information

Shape	Mounting type	Finish	IP Rating	Housing	Diffuser - Reflector	Lamp type	Driver type	Electrical class
Rectangular	Recessed	Powder Coated	IP 20	Extruded Aluminium	Diffuser	LED	HPF Isolated	II

## Technical specifications

Product code	Input voltage range	Input frequency	Operating temp. range	CCT	Lamp life expectancy at L70	CRI	Rated wattage efficacy (lm/W)	Surge Protection	Power factor	ITHD (%)	Beam angle
LSL 8030	100V-300V	50Hz	-10°C to +40°C	3000K 4000K 6000K	50Khrs	>80	75/80/85	4 kV	≥0.95	<10%	105°

Product code	High voltage cut off
--------------	----------------------

LSL 8030    ≥310 ± 10Vac

## Product dimensions

Wattage    Length (l)    Breadth (b)    Depth (h)    All dimensions in mm

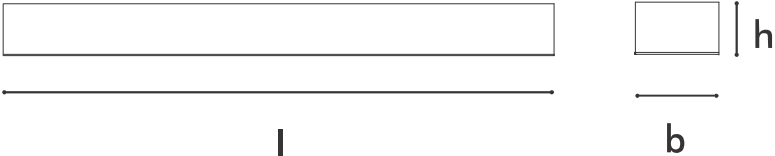
30W	1195	145	60	
-----	------	-----	----	--



# Slot

Surface/Recessed mounting single length individual luminary, aluminum extruded natural anodized housing with crystal clear. High lumen output product gives desired lux at low wattage.



## Features

- Extruded aluminium housing.
- Energy saving upto 90%
- Easy installation with fast connection.
- Low maintenance & long life span.
- Suitable for double height ceilings.



**4X** Energy Saving Efficiency



Available in 3 colors

## General information

Shape	Mounting type	Finish	IP Rating	Housing	Diffuser - Reflector	Lamp type	Driver type	Electrical class
Rectangular	Recessed/ Surface	Powder Coated	IP 40	Extruded Aluminium	Clear Diffuser	LED	HPF Isolated	I

## Technical specifications

Product code	Input voltage range	Input frequency	Operating temp. range	CCT	Lamp life expectancy at L70	CRI	Rated wattage efficacy (lm/W)	Surge Protection	Power factor	ITHD (%)	Beam angle
LSA 10090 - LSA 10100	120V-277V	50Hz	-10°C to +40°C	3000K 4000K 6000K	50Khrs	>80	110/115/120 - 105/110/115	4 kV	≥0.97	<10%	105°

Product code	Low voltage cut off	High voltage cut off
LSA 10090 - LSA 10100	Current fold back at 80Vac ± 10Vac	≥325 ± 10Vac

## Product dimensions

Wattage    Length (l)    Breadth (b)    Depth (h)    All dimensions in mm

90W  
-  
100W

1200

133

91

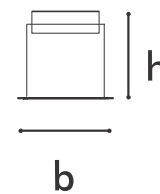
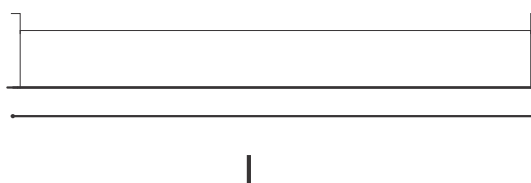



## Slot-D

Surface/Recessed mounting single length individual luminary, aluminum extruded natural anodized housing with PMMA diffuser. High lumen output product gives desired lux at low wattage.



## Features

- Extruded aluminium housing.
- Energy saving upto 90%
- Easy installation with fast connection.
- Low maintenance & long life span.
- Glare free evenly distributed.



**4X** Energy Saving Efficiency



Available in 3 colors

## General information

Shape	Mounting type	Finish	IP Rating	Housing	Diffuser - Reflector	Lamp type	Driver type	Electrical class
Rectangular	Recessed/ Surface	Powder Coated	IP 40	Extruded Aluminium	Diffuser	LED	HPF Isolated	I

## Technical specifications

Product code	Input voltage range	Input frequency	Operating temp. range	CCT	Lamp life expectancy at L70	CRI	Rated wattage efficacy (lm/W)	Surge Protection	Power factor	ITHD (%)	Beam angle
LSA 11090 - LSA 11100	120V-277V	50Hz	-10°C to +40°C	3000K 4000K 6000K	50Khrs	>80	90/95/100	4 kV	≥0.97	<10%	105°

Product code	Low voltage cut off	High voltage cut off
LSA 11090 - LSA 11100	Current fold back at 80Vac ± 10Vac	≥325 ± 10Vac

## Product dimensions

Wattage    Length (l)    Breadth (b)    Depth (h)    All dimensions in mm

90W  
-  
100W

1200

133

91

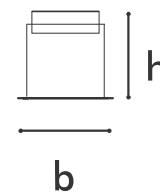
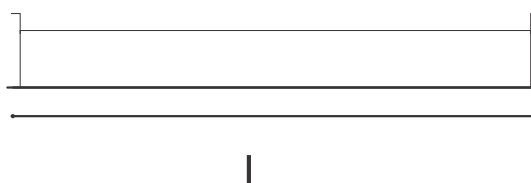



## Slot-N

Surface/Recessed mounting single length individual luminary, aluminum extruded natural anodized housing with PMMA diffuser. High lumen output product gives desired lux at low wattage.



## Features

- Extruded aluminium housing.
- Energy saving upto 90%
- Snap fit diffuser for ease in maintenance
- Low maintenance & long life span.
- Glare free evenly distributed.



**4X** Energy Saving Efficiency



Available in 3 colors

## General information

Shape	Mounting type	Finish	IP Rating	Housing	Diffuser - Reflector	Lamp type	Driver type	Electrical class
Rectangular	Recessed	Powder Coated	IP 40	Extruded Aluminium	Diffuser	LED	HPF Isolated	II

## Technical specifications

Product code	Input voltage range	Input frequency	Operating temp. range	CCT	Lamp life expectancy at L70	CRI	Rated wattage efficacy (lm/W)	Surge Protection	Power factor	ITHD (%)	Beam angle
LSA 09040 LSA 09050 LSA 09060 LSA 09075	100V-300V	50Hz	-10°C to +40°C	3000K 4000K 6000K	50Khrs	>80	90/95/100 85/90/95 85/90/95 85/90/95	4 kV	≥0.95	<10%	110°

Product code	High voltage cut off
LSA 09040 - LSA 09050 - LSA 09060 - LSA 09075	≥310 ± 10Vac

## Product dimensions

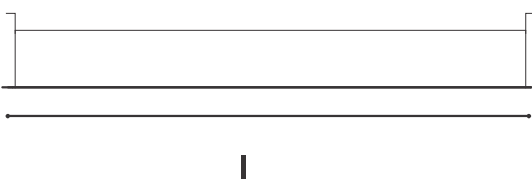
Wattage	Length (l)	Breadth (b)	Depth (h)	All dimensions in mm		
40W 50W 60W 75W	1200	103.5	90			



# Slit

Surface/Suspended mounting single length individual luminary, aluminum extruded natural anodized housing with PMMA diffuser. A high lumen output product gives desired lux at low wattage.



## Features

- Extruded aluminium housing.
- Glare free evenly distributed output.
- Long Life Span.
- Low height product.



**4X** Energy Saving Efficiency



Available in 3 colors

## General information

Shape	Mounting type	Finish	IP Rating	Housing	Diffuser - Reflector	Lamp type	Driver type	Electrical class
Rectangular	Surface/Suspended	Powder Coated	IP 40	Extruded Aluminium	Diffuser	LED	HPF Isolated	II

## Technical specifications

Product code	Input voltage range	Input frequency	Operating temp. range	CCT	Lamp life expectancy at L70	CRI	Rated wattage efficacy (lm/W)	Surge Protection	Power factor	ITHD (%)	Beam angle
LSA 15070	100V-300V	50Hz	-10°C to +40°C	3000K 4000K 6000K	50Khrs	>80	85/90/95	4 kV	≥0.95	<10%	105°

Product code	High voltage cut off
--------------	----------------------

LSA 15070 ≥310 ± 10Vac

## Product dimensions

Wattage	Length (l)	Breadth (b)	Depth (h)	All dimensions in mm			
---------	------------	-------------	-----------	----------------------	--	--	--

70W      1200      150      110

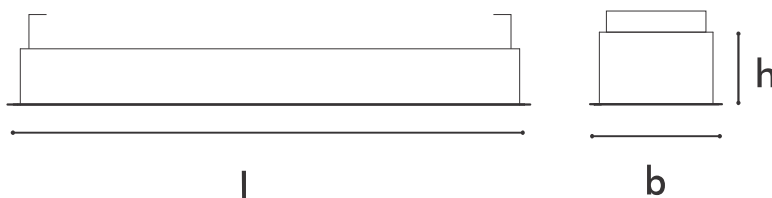



## Pill-2.0

Round extruded aluminium housing with opal PMMA diffuser. Smart circular disk fixture, Pill-2.0 suspended gives functional decorative look. Also opal PMMA diffuser is so fixed in inner periphery of extrusion to cut down the glare & provide uniform light output.



### Features

- Circular disk made of special aluminium bending technology.
- Laser cut HTF diffuser for improved efficiency.
- Precise dimension.
- Aesthetically appealing.
- Special PC diffuser designed for LED source.



**4X** Energy Saving Efficiency



Available in 3 colors

## General information

Shape	Mounting type	Finish	IP Rating	Housing	Diffuser - Reflector	Lamp type	Driver type	Electrical class
Round	Suspended	Powder Coated	IP 20	Extruded Aluminium	Diffuser	LED	HPF Isolated	II

## Technical specifications

Product code	Input voltage range	Input frequency	Operating temp. range	CCT	Lamp life expectancy at L70	CRI	Rated wattage efficacy (lm/W)	Surge Protection	Power factor	ITHD (%)	Beam angle
APP-S 4130	100V-300V	50Hz	-10°C to +40°C	3000K	50Khrs	>80	75/80/85	4 kV	≥0.95	<10%	110°
APP-S 4145				4000K			70/75/80				
APP-S 5156				6000K			65/70/75				
APP-S 6180				65/70/75							
APP-S 12100				65/70/75							

## Product dimensions

Wattage    Diameter (ø)    Breadth (b)    Depth (h)    All dimensions in mm

30W	400	NA	65
45W	500		
56W	600		
80W	900		
100W	1170		

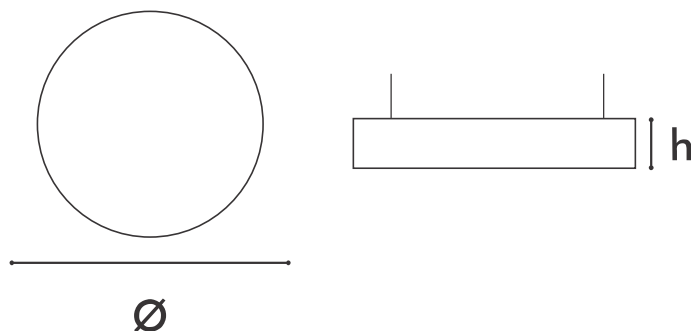



# Pill Suspended

Round extruded aluminium housing with Opal PMMA diffuser. High efficient LEDs for uniform light distribution.



## Features

- Circular disk made of special aluminium bending technology.
- Laser cut HTF diffuser for improved efficiency.
- Precise dimension.
- Aesthetically appealing.
- Special PC diffuser designed for LED source.



**4X** Energy Saving Efficiency



Available in 3 colors

## General information

Shape	Mounting type	Finish	IP Rating	Housing	Diffuser - Reflector	Lamp type	Driver type	Electrical class
Round	Suspended	Powder Coated	IP 20	Extruded Aluminium	Diffuser	LED	HPF Isolated	II

## Technical specifications

Product code	Input voltage range	Input frequency	Operating temp. range	CCT	Lamp life expectancy at L70	CRI	Rated wattage efficacy (lm/W)	Surge Protection	Power factor	ITHD (%)	Beam angle
ALP-S 4130	100V-300V	50Hz	-10°C to +40°C	3000K	50Khrs	>80	75/80/85	4 kV	≥0.95	<10%	110°
-				4000K			-				
ALP-S 5145				6000K			70/75/80				
-				-			-				
ALP-S 6156				65/70/75			-				
-				-			-				
ALP-S 9180	65/70/75	-									
-	-	-									
ALP-S 12100	65/70/75	-									

## Product dimensions

Wattage    Diameter (ø)    Breadth (b)    Depth (h)    All dimensions in mm

30W	400	NA	60
-	-		
45W	500		
-	-		
56W	600		
-	-		
80W	900		
-	-		
100W	1170		

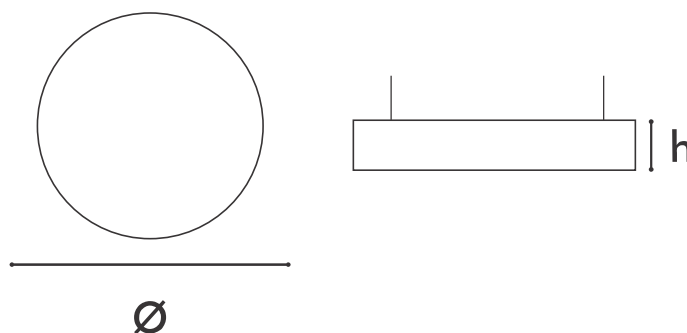



## Pill Recessed

Round luminaire aluminium, rolled profile, seamlessly welded housing with integrated tool-less suspension height adjustment. Highly reflective coating for improved efficiency with high transmission factor PMMA diffuser. Rolled aluminium frame accessory along with fixture for ease in installation.



## Features

- Circular disk made of CRCA body
- HTF diffuser for improved efficiency.
- Precise dimension.
- Aesthetically appealing.
- Special PC diffuser designed for LED source.



**4X** Energy Saving Efficiency



Available in 3 colors

## General information

Shape	Mounting type	Finish	IP Rating	Housing	Diffuser - Reflector	Lamp type	Driver type	Electrical class
Round	Recessed	Powder Coated	IP 20	CRCA	Diffuser	LED	HPF Isolated	II

## Technical specifications

Product code	Input voltage range	Input frequency	Operating temp. range	CCT	Lamp life expectancy at L70	CRI	Rated wattage efficacy (lm/W)	Surge Protection	Power factor	ITHD (%)	Beam angle
ALP-R 4230 - ALP-R 5245 - ALP-R 6256	100V-300V	50Hz	-10°C to +40°C	3000K 4000K 6000K	50Khrs	>80	70/75/80 65/70/75 65/70/75	4 kV	≥0.95	<10%	110°

## Product dimensions

Wattage    Diameter (ø)    Breadth (b)    Depth (h)    All dimensions in mm

30W	395		95
-	-		-
45W	527	NA	93
-	-		-
56W	635		93

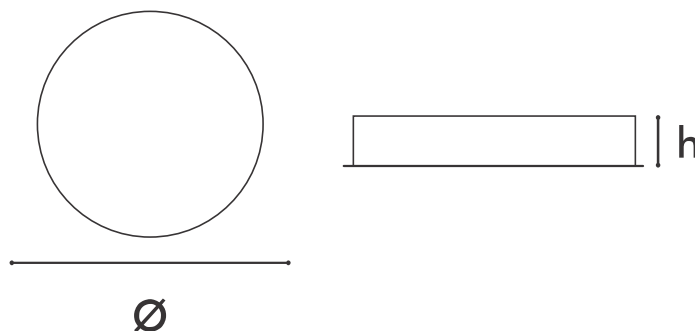



## Pill Surface

Round luminaire aluminium, rolled profile, seamlessly welded housing with integrated tool-less suspension height adjustment. Highly reflective coating for improved efficiency with high transmission factor PMMA diffuser.



## Features

- Circular disk made of CRCA body
- HTF diffuser for improved efficiency.
- Precise dimension.
- Aesthetically appealing.
- Special PC diffuser designed for LED source.



**4X** Energy Saving Efficiency



Available in 3 colors

## General information

Shape	Mounting type	Finish	IP Rating	Housing	Diffuser - Reflector	Lamp type	Driver type	Electrical class
Round	Surface	Powder Coated	IP 20	Extruded Aluminium	Diffuser	LED	HPF Isolated	II

## Technical specifications

Product code	Input voltage range	Input frequency	Operating temp. range	CCT	Lamp life expectancy at L70	CRI	Rated wattage efficacy (lm/W)	Surge Protection	Power factor	ITHD (%)	Beam angle
ASP 4330	100V-300V	50Hz	-10°C to +40°C	3000K	50Khrs	>80	75/80/85	4 kV	≥0.95	<10%	110°
ASP 5345				4000K			70/75/80				
ASP 5350				6000K			65/70/75				
ASP 9380				65/70/75							

## Product dimensions

Wattage    Diameter (ø)    Breadth (b)    Depth (h)    All dimensions in mm

30W	400	NA	110
45W	500		110
50W	600		110
80W	900		110

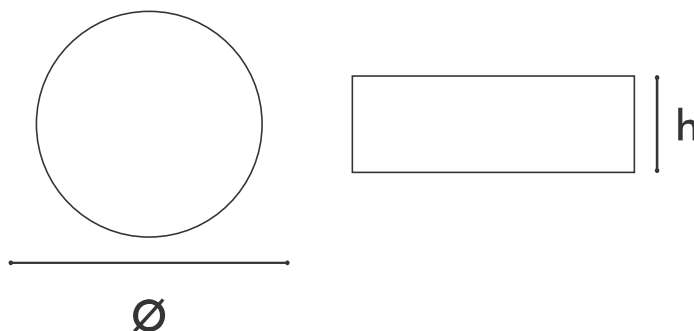



## Ripple - 2.0

Suspended mounted round extruded aluminium housing with opal PMMA diffuser. Smart Circular ring fixture gives decorative look to the product. Also Opal diffuser is so fixed at inner periphery of extrusion to cut down the glare & provide uniform light output.



### Features

- Made of special aluminium bending technology
- Laser cut HTF diffuser for improved efficiency
- Precise dimension
- Aesthetically appealing
- Special PC diffuse designed for LED



**4X** Energy Saving Efficiency



Available in 3 colors

## General information

Shape	Mounting type	Finish	IP Rating	Housing	Diffuser - Reflector	Lamp type	Driver type	Electrical class
Round	Suspended	Powder Coated	IP 20	Extruded Aluminium	Diffuser	LED	HPF Isolated	II

## Technical specifications

Product code	Input voltage range	Input frequency	Operating temp. range	CCT	Lamp life expectancy at L70	CRI	Rated wattage efficacy (lm/W)	Surge Protection	Power factor	ITHD (%)	Beam angle
ARP 6030 ARP 9055 ARP 12100	100V-300V	50Hz	-10°C to +40°C	3000K 4000K 6000K	50Khrs	>80	65/70/75	4 kV	≥0.95	<10%	110°

## Product dimensions

Wattage    Diameter (ø)    Depth (h)    Inner Dia (a)    All dimensions in mm

30W	600	65	400
55W	900		700
100W	1170		970

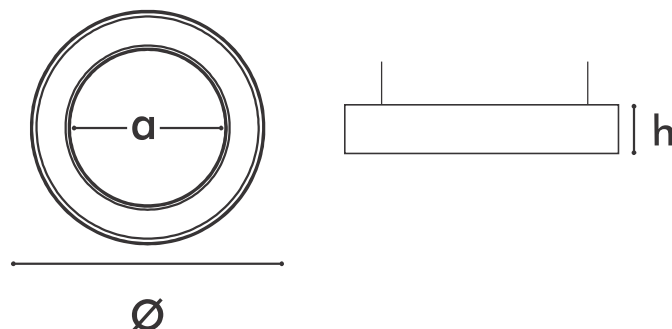



# Ripple

Round extruded aluminium housing with opal PMMA diffuser. Smart circular ring gives functional decorative look. Also opal PMMA diffuser is so fixed to provide uniform light output.



## Features

- Made of special aluminium bending technology
- Laser cut HTF diffuser for improved efficiency
- Precise dimension
- Aesthetically appealing
- Special PC diffuse designed for LED



**4X** Energy Saving Efficiency



Available in 3 colors

## General information

Shape	Mounting type	Finish	IP Rating	Housing	Diffuser - Reflector	Lamp type	Driver type	Electrical class
Round	Suspended	Powder Coated	IP 20	Extruded Aluminium	Diffuser	LED	HPF Isolated	II

## Technical specifications

Product code	Input voltage range	Input frequency	Operating temp. range	CCT	Lamp life expectancy at L70	CRI	Rated wattage efficacy (lm/W)	Surge Protection	Power factor	ITHD (%)	Beam angle
ARL 6030 - ARL 9055 - ARL 12080	100V-300V	50Hz	-10°C to +40°C	3000K 4000K 6000K	50Khrs	>80	65/70/75	4 kV	≥0.95	<10%	110°

## Product dimensions

Wattage    Diameter (∅)    Depth (h)    Inner Dia (a)    All dimensions in mm

30W	600	60	400
55W	900		700
80W	1170		970

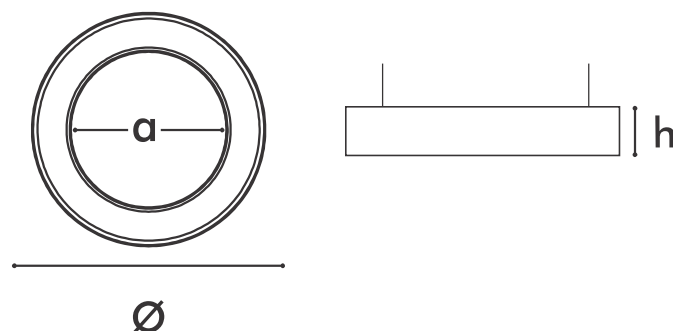



# Crescent

Extruded Aluminum housing in Circular Arc form with PMMA Diffuser. High efficient LEDs with uniform light distribution.



## Features

- Made of special aluminium bending technology
- Laser cut HTF diffuser for improved efficiency
- Precise dimension
- Aesthetically appealing
- Special PC diffuse designed for LED



**4X** Energy Saving Efficiency



Available in 3 colors

## General information

Shape	Mounting type	Finish	IP Rating	Housing	Diffuser - Reflector	Lamp type	Driver type	Electrical class
Circular ARC	Suspended	Powder Coated	IP 20	Extruded Aluminium	Diffuser	LED	HPF Isolated	II

## Technical specifications

Product code	Input voltage range	Input frequency	Operating temp. range	CCT	Lamp life expectancy at L70	CRI	Rated wattage efficacy (lm/W)	Surge Protection	Power factor	ITHD (%)	Beam angle
ACL 6030	100V-300V	50Hz	-10°C to +40°C	3000K 4000K 6000K	50Khrs	>80	45/50/55	4 kV	≥0.95	<10%	110°

## Product dimensions

Wattage    Length (l)    Breadth (b)    Depth (h) All dimensions in mm

30W    801.3    301.6    60

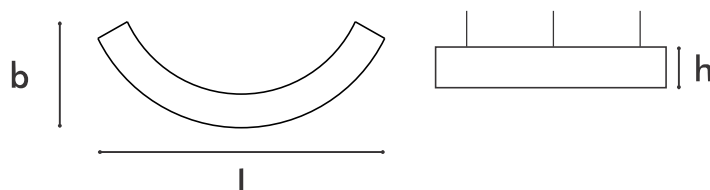

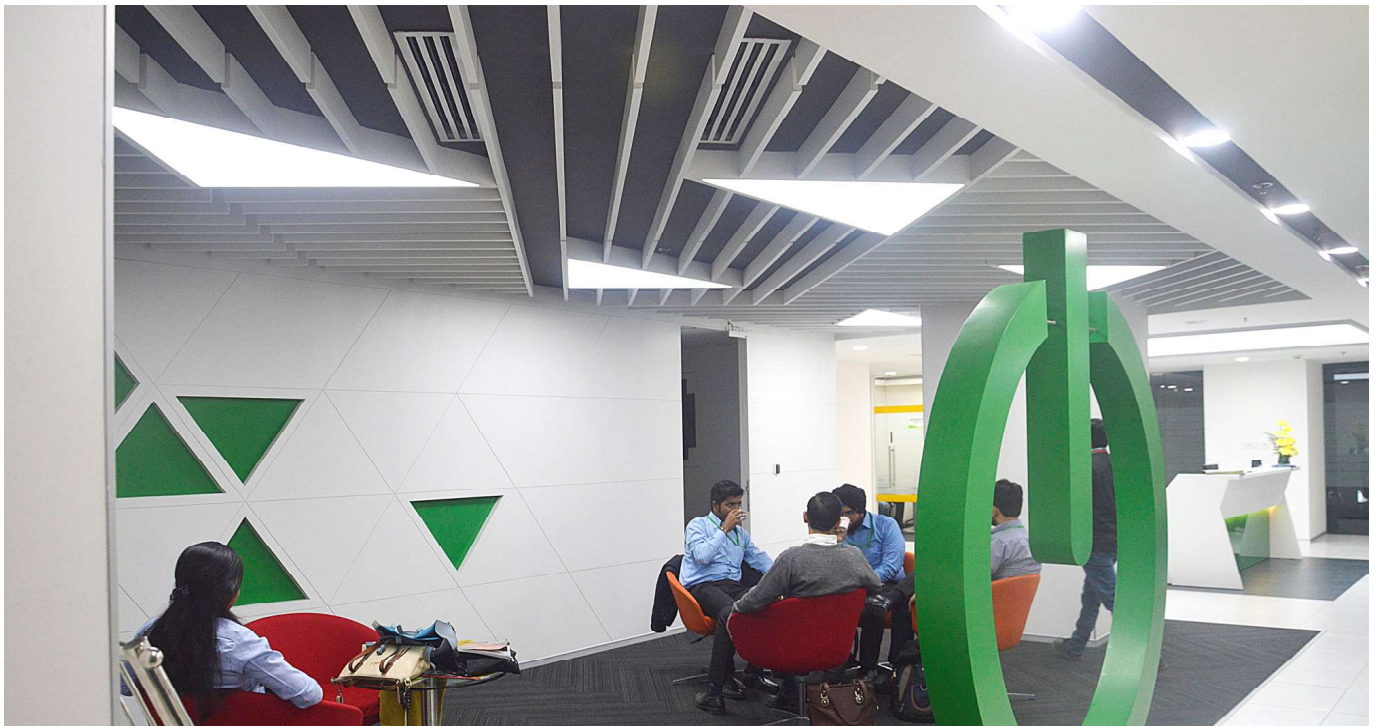

# Trio

Triangular extruded aluminium housing with soft corner and opal PMMA diffuser. High efficient LEDs for uniform light.



## Features

- Customizable to certain sizes on request.
- Laser cut HTF diffuser for improved efficiency.
- Aluminium extrusion housing.
- Especial PMMA diffuse designed for LED glare control.
- Aesthetically appealing.



**4X** Energy Saving Efficiency



Available in 3 colors

## General information

Shape	Mounting type	Finish	IP Rating	Housing	Diffuser - Reflector	Lamp type	Driver type	Electrical class
Triangular	Suspended	Powder Coated	IP 20	Extruded Aluminium	Diffuser	LED	HPF Isolated	II

## Technical specifications

Product code	Input voltage range	Input frequency	Operating temp. range	CCT	Lamp life expectancy at L70	CRI	Rated wattage efficacy (lm/W)	Surge Protection	Power factor	ITHD (%)	Beam angle
ATL-S 3030	100V-300V	50Hz	-10°C to +40°C	3000K 4000K 6000K	50Khrs	>80	70/75/80	4 kV	≥0.95	<10%	110°

## Product dimensions

Wattage    Length (l)    Breadth (b)    Depth (h) All dimensions in mm

30W    511    465    88

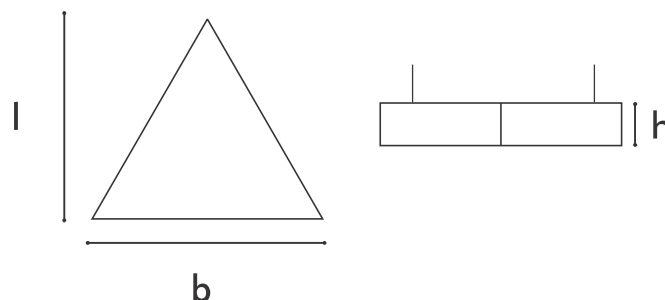



# Hexo

The extruded aluminium housing in hexagon shape with opal PMMA diffuser. High efficient LEDs for uniform light distribution.

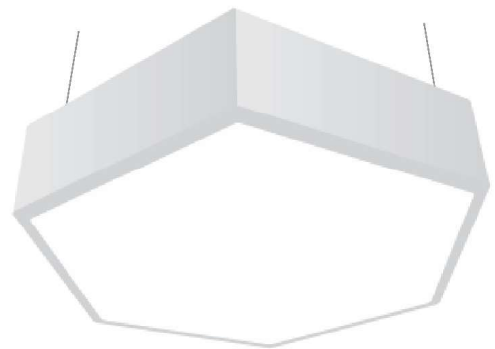

## Features

- Customizable to certain sizes on request.
- Laser cut HTF diffuser for improved efficiency.
- Aluminium extrusion housing.
- Especial PMMA diffuse designed for LED glare control.
- Aesthetically appealing.



**4X** Energy Saving Efficiency



Available in 3 colors

## General information

Shape	Mounting type	Finish	IP Rating	Housing	Diffuser - Reflector	Lamp type	Driver type	Electrical class
Hexagon	Suspended	Powder Coated	IP 20	Extruded Aluminium	Diffuser	LED	HPF Isolated	II

## Technical specifications

Product code	Input voltage range	Input frequency	Operating temp. range	CCT	Lamp life expectancy at L70	CRI	Rated wattage efficacy (lm/W)	Surge Protection	Power factor	ITHD (%)	Beam angle
AHL 6040	100V-300V	50Hz	-10°C to +40°C	3000K 4000K 6000K	50Khrs	>80	65/70/75	4 kV	≥0.95	<10%	110°

## Product dimensions

Wattage    Length (l)    Breadth (b)    Depth (h) All dimensions in mm

40W

672

582

60

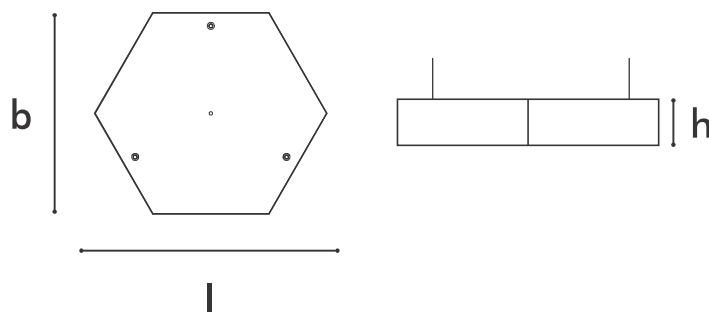



# Recto

Rectangular shape extruded aluminium housing with opal PMMA diffuser gives functional look. Also high efficient LEDs & diffuser combination gives smooth & uniform light.

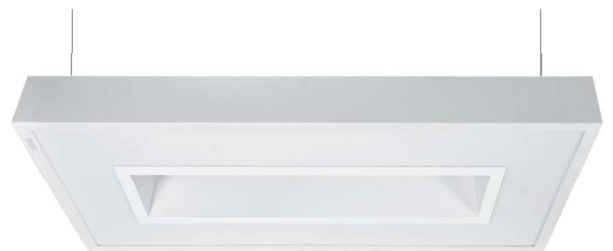

## Features

- Laser cut HTF diffuser for improved efficiency
- Aluminium extrusion housing
- Opal PMMA diffuser to provide glare free uniform output.
- Aesthetically appealing



**4X** Energy Saving Efficiency



Available in 3 colors

## General information

Shape	Mounting type	Finish	IP Rating	Housing	Diffuser - Reflector	Lamp type	Driver type	Electrical class
Rectangular	Suspended	Powder Coated	IP 20	Extruded Aluminium	Diffuser	LED	HPF Isolated	II

## Technical specifications

Product code	Input voltage range	Input frequency	Operating temp. range	CCT	Lamp life expectancy at L70	CRI	Rated wattage efficacy (lm/W)	Surge Protection	Power factor	ITHD (%)	Beam angle
ARL 6330	100V-300V	50Hz	-10°C to +40°C	3000K 4000K 6000K	50Khrs	>80	65/70/75	4 kV	≥0.95	<10%	110°

Product code	High voltage cut off
--------------	----------------------

ARL 6330 ≥310 ± 10Vac

## Product dimensions

Wattage    Length (l)    Breadth (b)    Depth (h)

All dimensions in mm

30W

600

300

60

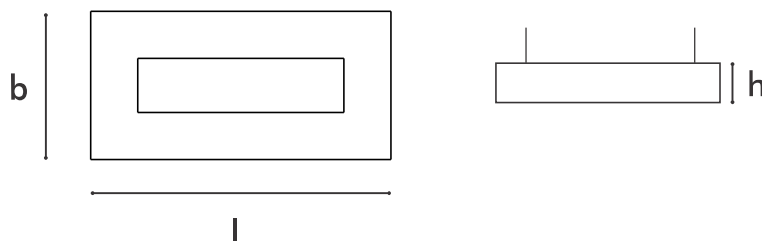



## Frame

Square extruded aluminium housing with opal PMMA diffuser. Geometrical shape blends perfectly with ceiling design & gives unique product look.



## Features

- Laser cut HTF diffuser for improved efficiency
- Aluminium extrusion housing
- Opal PMMA diffuser to provide glare free uniform output.
- Aesthetically appealing



**4X** Energy Saving Efficiency



Available in 3 colors

## General information

Shape	Mounting type	Finish	IP Rating	Housing	Diffuser - Reflector	Lamp type	Driver type	Electrical class
Square	Suspended	Powder Coated	IP 20	Extruded Aluminium	Diffuser	LED	HPF Isolated	II

## Technical specifications

Product code	Input voltage range	Input frequency	Operating temp. range	CCT	Lamp life expectancy at L70	CRI	Rated wattage efficacy (lm/W)	Surge Protection	Power factor	ITHD (%)	Beam angle
AFL 5030	100V-300V	50Hz	-10°C to +40°C	3000K 4000K 6000K	50Khrs	>80	50/55/60	4 kV	≥0.95	<10%	110°

Product code	High voltage cut off
--------------	----------------------

AFL 5030	≥310 ± 10Vac
----------	--------------

## Product dimensions

Wattage	Length (l)	Breadth (b)	Depth (h)
---------	------------	-------------	-----------

All dimensions in mm

30W	500	500	60
-----	-----	-----	----

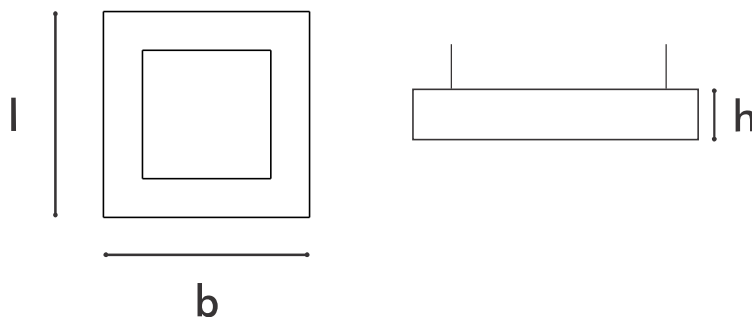



# Petal

Extruded aluminium housing designed in leaf shape for unique & decorative look. Opal PMMA diffuser is used to give smooth & glare free light output.



## Features

- Laser cut HTF diffuser for improved efficiency
- Aluminium extrusion housing
- Opal PMMA diffuser to provide glare free uniform output.
- Aesthetically appealing



**4X** Energy Saving Efficiency



Available in 3 colors

## General information

Shape	Mounting type	Finish	IP Rating	Housing	Diffuser - Reflector	Lamp type	Driver type	Electrical class
Leaf	Suspended	Powder Coated	IP 20	Extruded Aluminium	Diffuser	LED	HPF Isolated	II

## Technical specifications

Product code	Input voltage range	Input frequency	Operating temp. range	CCT	Lamp life expectancy at L70	CRI	Rated wattage efficacy (lm/W)	Surge Protection	Power factor	ITHD (%)	Beam angle
APL 6330	100V-300V	50Hz	-10°C to +40°C	3000K 4000K 6000K	50Khrs	>80	45/50/55	4 kV	≥0.95	<10%	110°

Product code	High voltage cut off
--------------	----------------------

APL 6330 ≥310 ± 10Vac

## Product dimensions

Wattage	Length (l)	Breadth (b)	Depth (h)	All dimensions in mm			
---------	------------	-------------	-----------	----------------------	--	--	--

30W      609      307      60

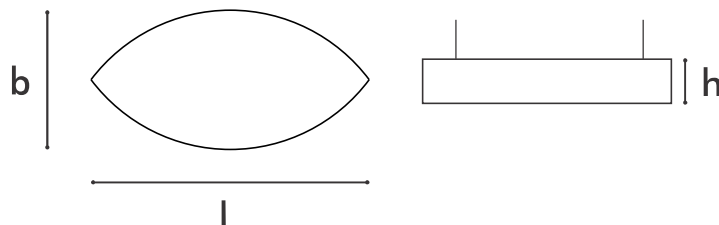



## D Lite

The decorative luminaire suitable for LED bulbs available in different color options. Designer product suitable for various interior intent size option offers flexibility with respect to product application. Neat design with minimalistic approach.



## Features

- Stylish elegant design.
- Suitable for breakout, cafeteria.
- Available in various housing color options.
- Retro fit light source in multiple wattages.



**4X** Energy Saving Efficiency



Available in 3 colors

Other Color Available As Per Request

## General information

Shape	Mounting type	Finish	IP Rating	Housing	Diffuser - Reflector	Lamp type	Driver type	Electrical class
Round	Suspended	Powder Coated	IP 20	Aluminium	Diffuser	LED	HPF Non-Isolated	II

## Technical specifications

Product code	Input voltage range	Input frequency	Operating temp. range	CCT	Lamp life expectancy at L70	CRI	Rated wattage efficacy (lm/W)	Surge Protection	Power factor	ITHD (%)	Beam angle
LDT_300	100V-300V	50Hz	-10°C to +50°C	3000K	25Khrs	>80	85/90/95	2.5 kV	≥0.95	<20%	130°
LDT_380				4000K			85/90/95				
LDT_425				6000K			80/85/90				
LDT_600				80/85/90							

## Product dimensions

Wattage      Diameter (∅)      Breadth (b)      Depth (h)      All dimensions in mm

9W/12W/15W	305	NA	185
	373		205
	425		210
	600		320

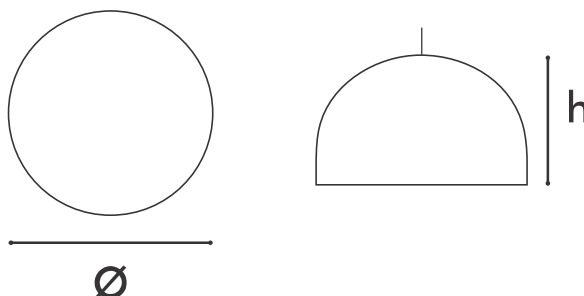



## Zeta

The decorative luminaire suitable for LED bulbs available in different color options. Inspired by water droplet, fixture has fluid design intent. Softness in design makes it suitable for almost any interior fit out.



## Features

- Stylish elegant design.
- Suitable for breakout, cafeteria.
- Available in various housing color options.
- Retro fit light source in multiple wattages.



**4X** Energy Saving Efficiency



Available in 3 colors

Other Color Available As Per Request

## General information

Shape	Mounting type	Finish	IP Rating	Housing	Diffuser - Reflector	Lamp type	Driver type	Electrical class
Round	Suspended	Powder Coated	IP 20	Aluminium	Diffuser	LED Bulb & E27 Base	HPF Non-Isolated	II

## Technical specifications

Product code	Input voltage range	Input frequency	Operating temp. range	CCT	Lamp life expectancy at L70	CRI	Rated wattage efficacy (lm/W)	Surge Protection	Power factor	ITHD (%)	Beam angle
LZTE 3030	100V-300V	50Hz	-10°C to +50°C	3000K	25Khrs	>80	80/85/90	2.5 kV	≥0.95	<20%	100°
LZTE 3020				4000K			80/85/90				
LZTE 3010				6000K			75/80/85				

## Product dimensions

Wattage      Diameter (Ø)      Breadth (b)      Depth (h)      All dimensions in mm

9W/12W/15W	257	NA	210
	368		280
	420		280

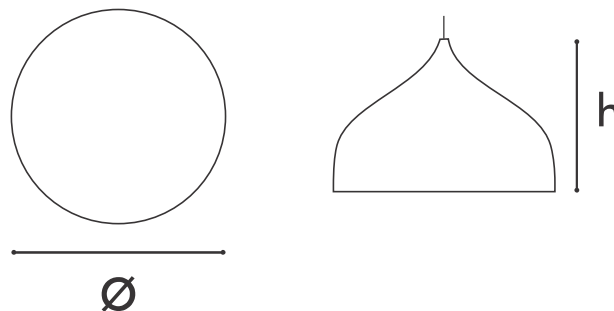



# Mole

The decorative luminaire suitable for LED bulbs available in different color options. Compact and cute design which can be used in a cluster. Simple and yet elegant, Mole can be used on various breakout areas of both residential and commercial fit outs.



## Features

- Stylish elegant design.
- Suitable for breakout, cafeteria.
- Available in various housing color options.
- Retro fit light source in multiple wattages.



**4X** Energy Saving Efficiency



Available in 3 colors

Other Color Available As Per Request

## General information

Shape	Mounting type	Finish	IP Rating	Housing	Diffuser - Reflector	Lamp type	Driver type	Electrical class
Round	Suspended	Powder Coated	IP 20	Aluminium	Diffuser	LED Bulb & E27 Base	HPF Non-Isolated	II

## Technical specifications

Product code	Input voltage range	Input frequency	Operating temp. range	CCT	Lamp life expectancy at L70	CRI	Rated wattage efficacy (lm/W)	Surge Protection	Power factor	ITHD (%)	Beam angle
LMOL 205	100V-300V	50Hz	-10°C to +50°C	3000K 4000K 6000K	25Khrs	>80	85/90/95	2.5 kV	≥0.95	<20%	130°

## Product dimensions

Wattage    Diameter (∅)    Breadth (b)    Depth (h) All dimensions in mm

7W/9W

205

NA

175

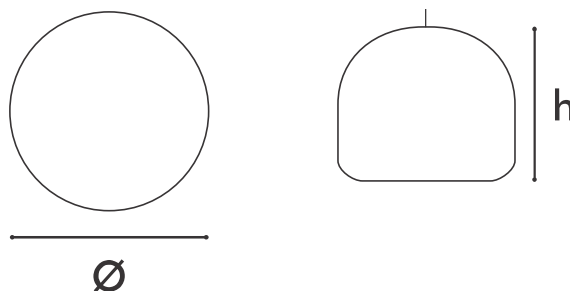



# Tope

The decorative luminaire suitable for LED bulbs available in different color options. Tope with industrial touch and robust feel is inspired from grunge design.



## Features

- Stylish elegant design.
- Suitable for breakout, cafeteria.
- Available in various housing color options.
- Retro fit light source in multiple wattages.



**4X** Energy Saving Efficiency



Available in 3 colors

Other Color Available As Per Request

# Get in Touch with Us

---

## Contact Us:

**Mr. Laxmikant Laddha:** 09822332340

**Giriraj Laddha:** 09881245431

**Rahul Laddha:** 09881245432

 [sales@rajelectricals.co.in](mailto:sales@rajelectricals.co.in)

 <https://rajelectricals.co.in/>



## Lighting Store:

583, Narayan Peth, Jaldhara Society,  
Near Kanyashala, Pune-411030

**Phone:** (020) 24455293, 24461156,  
24481583, 24486306, 24492424



## Electrical Store:

353/2, Shaniwar Peth, Ramanbaug  
Co-operative Hsg Society, Near  
Ramanbaug School, Pune-411030.

**Phone:** 098812 45432



[rajelectricalspune](https://www.facebook.com/rajelectricalspune)



[raj\\_\\_electricals](https://www.instagram.com/raj__electricals)